



**THE DATASHEET OF
PMLL4148L,115**



PMLL4148L; PMLL4448

High-speed switching diodes

Rev. 8 — 1 February 2011

Product data sheet

1. Product profile

1.1 General description

Single high-speed switching diodes, fabricated in planar technology, and encapsulated in small hermetically sealed glass SOD80C Surface-Mounted Device (SMD) packages.

Table 1. Product overview

| Type number | Package | Configuration |
|-------------|---------|---------------|
| PMLL4148L | SOD80C | single |
| PMLL4448 | | |

1.2 Features and benefits

- High switching speed: $t_{rr} \leq 4$ ns
- Reverse voltage: $V_R \leq 75$ V
- Repetitive peak reverse voltage: $V_{RRM} \leq 100$ V
- Repetitive peak forward current: $I_{FRM} \leq 450$ mA
- Small hermetically sealed glass SMD package

1.3 Applications

- High-speed switching
- Reverse polarity protection

1.4 Quick reference data

Table 2. Quick reference data

| Symbol | Parameter | Conditions | Min | Typ | Max | Unit |
|-----------|---------------------------------|----------------|-----|-----|-----|------|
| I_F | forward current | | [1] | - | 200 | mA |
| I_{FRM} | repetitive peak forward current | | - | - | 450 | mA |
| V_R | reverse voltage | | - | - | 75 | V |
| V_F | forward voltage | | | | | |
| | PMLL4148L | $I_F = 50$ mA | - | - | 1 | V |
| | PMLL4448 | $I_F = 5$ mA | 620 | - | 720 | mV |
| | | $I_F = 100$ mA | - | - | 1 | V |
| t_{rr} | reverse recovery time | | [2] | - | 4 | ns |

[1] Device mounted on an FR4 Printed-Circuit Board (PCB), single-sided copper, tin-plated and standard footprint.

[2] When switched from $I_F = 10$ mA to $I_R = 60$ mA; $R_L = 100$ Ω ; measured at $I_R = 1$ mA.

2. Pinning information

Table 3. Pinning

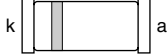
| Pin | Description | Simplified outline | Graphic symbol |
|-----|-------------|---|---|
| 1 | cathode | [1] |  sym006 |
| 2 | anode |  | |

[1] The marking band indicates the cathode.

3. Ordering information

Table 4. Ordering information

| Type number | Package | | Version |
|-------------|---------|--|---------|
| | Name | Description | |
| PMLL4148L | - | hermetically sealed glass surface-mounted package; | SOD80C |
| PMLL4448 | - | 2 connectors | |

4. Marking

Table 5. Marking codes

| Type number | Marking code |
|-------------|--------------|
| PMLL4148L | marking band |
| PMLL4448 | marking band |

5. Limiting values

Table 6. Limiting values

In accordance with the Absolute Maximum Rating System (IEC 60134).

| Symbol | Parameter | Conditions | Min | Max | Unit | |
|-----------|-------------------------------------|-----------------------|-----|-----|------|---|
| V_{RRM} | repetitive peak reverse voltage | | - | 100 | V | |
| V_R | reverse voltage | | - | 75 | V | |
| I_F | forward current | [1] | - | 200 | mA | |
| I_{FRM} | repetitive peak forward current | | - | 450 | mA | |
| I_{FSM} | non-repetitive peak forward current | square wave | [2] | | | |
| | | $t_p = 1 \mu\text{s}$ | | - | 4 | A |
| | | $t_p = 1 \text{ms}$ | | - | 1 | A |
| | | $t_p = 1 \text{s}$ | | - | 0.5 | A |

Table 6. Limiting values ...continued

In accordance with the Absolute Maximum Rating System (IEC 60134).

| Symbol | Parameter | Conditions | Min | Max | Unit |
|------------------|-------------------------|---------------------------------|-------|------|------|
| P_{tot} | total power dissipation | $T_{\text{amb}} = 25\text{ °C}$ | [1] - | 500 | mW |
| T_j | junction temperature | | - | 200 | °C |
| T_{amb} | ambient temperature | | -65 | +200 | °C |
| T_{stg} | storage temperature | | -65 | +200 | °C |

[1] Device mounted on an FR4 PCB, single-sided copper, tin-plated and standard footprint.

[2] $T_j = 25\text{ °C}$ prior to surge.

6. Thermal characteristics

Table 7. Thermal characteristics

| Symbol | Parameter | Conditions | Min | Typ | Max | Unit |
|-----------------------|--|-------------|-------|-----|-----|------|
| $R_{\text{th}(j-a)}$ | thermal resistance from junction to ambient | in free air | [1] - | - | 350 | K/W |
| $R_{\text{th}(j-sp)}$ | thermal resistance from junction to solder point | | - | - | 300 | K/W |

[1] Device mounted on an FR4 PCB, single-sided copper, tin-plated and standard footprint.

7. Characteristics

Table 8. Characteristics $T_{\text{amb}} = 25\text{ °C}$ unless otherwise specified.

| Symbol | Parameter | Conditions | Min | Typ | Max | Unit |
|----------|--------------------------|--|-------|-----|-----|------|
| V_F | forward voltage | | | | | |
| | PMLL4148L | $I_F = 50\text{ mA}$ | - | - | 1 | V |
| | PMLL4448 | $I_F = 5\text{ mA}$ | 620 | - | 720 | mV |
| | | $I_F = 100\text{ mA}$ | - | - | 1 | V |
| I_R | reverse current | $V_R = 20\text{ V}$ | - | - | 25 | nA |
| | | $V_R = 20\text{ V}; T_j = 150\text{ °C}$ | - | - | 50 | μA |
| I_R | reverse current | | | | | |
| | PMLL4448 | $V_R = 20\text{ V}; T_j = 100\text{ °C}$ | - | - | 3 | μA |
| C_d | diode capacitance | $V_R = 0\text{ V}; f = 1\text{ MHz}$ | - | - | 4 | pF |
| t_{rr} | reverse recovery time | | [1] - | - | 4 | ns |
| V_{FR} | forward recovery voltage | | [2] - | - | 2.5 | V |

[1] When switched from $I_F = 10\text{ mA}$ to $I_R = 60\text{ mA}$; $R_L = 100\text{ Ω}$; measured at $I_R = 1\text{ mA}$.[2] When switched from $I_F = 50\text{ mA}$; $t_r = 20\text{ ns}$.

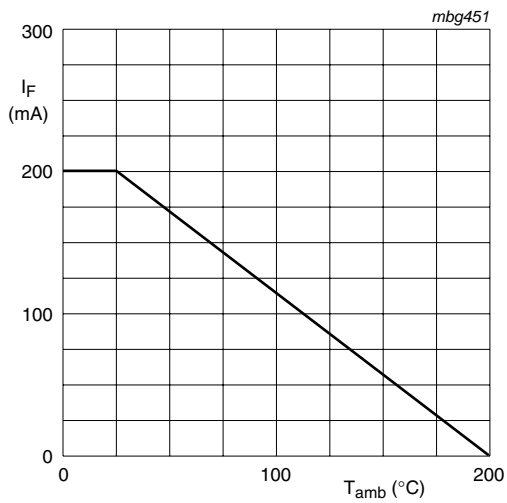

FR4 PCB, standard footprint

Fig. 1. Forward current as a function of ambient temperature; derating curve

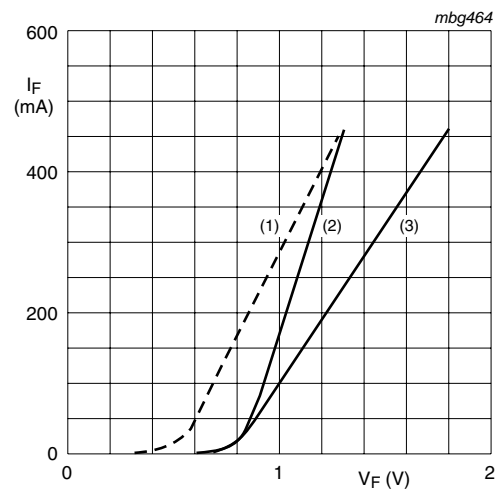

- (1) T_j = 175 °C; typical values
- (2) T_j = 25 °C; typical values
- (3) T_j = 25 °C; maximum values

Fig. 2. Forward current as a function of forward voltage

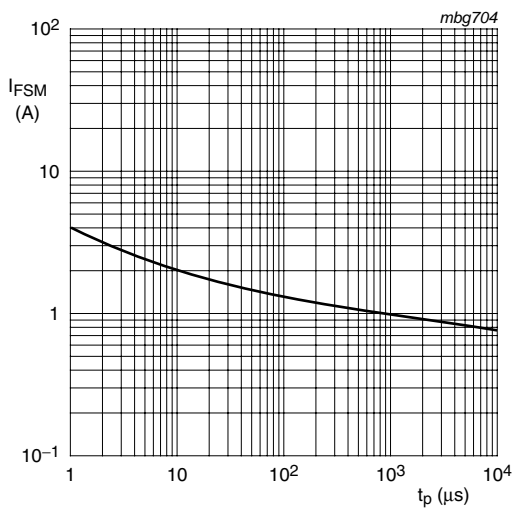

Based on square wave currents.
T_j = 25 °C; prior to surge

Fig. 3. Non-repetitive peak forward current as a function of pulse duration; maximum values

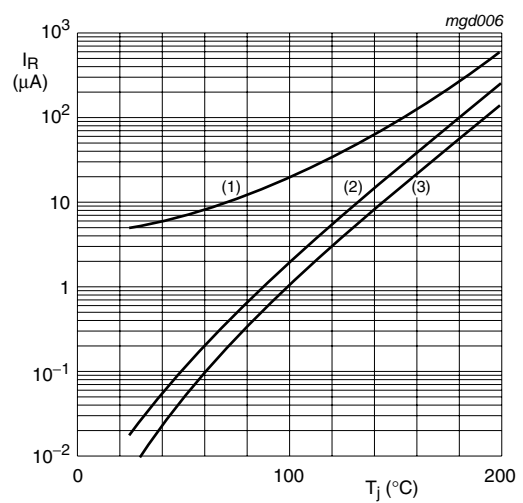

- (1) V_R = 75 V; maximum values
- (2) V_R = 75 V; typical values
- (3) V_R = 20 V; typical values

Fig. 4. Reverse current as a function of junction temperature

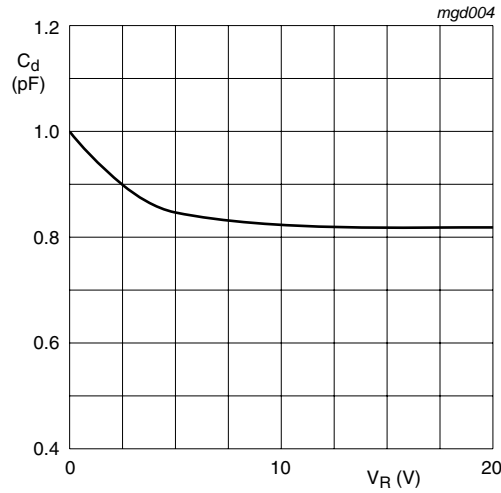

f = 1 MHz; T_j = 25 °C

Fig 5. Diode capacitance as a function of reverse voltage; typical values

8. Test information

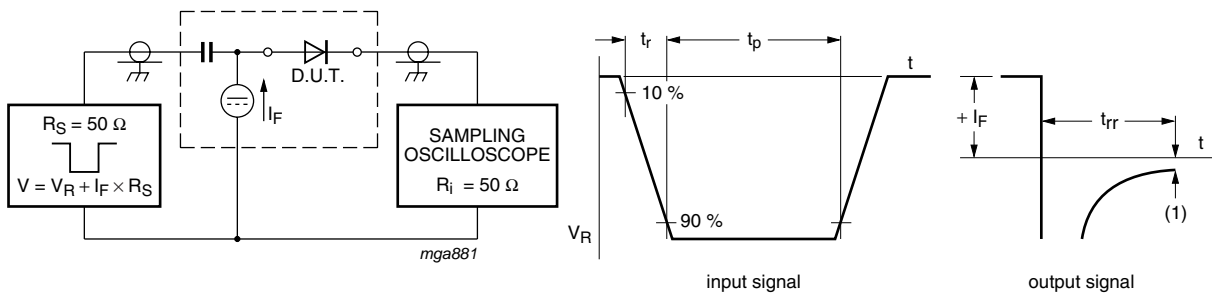

(1) I_R = 1 mA

Input signal: reverse pulse rise time $t_r = 0.6$ ns; reverse voltage pulse duration $t_p = 100$ ns; duty cycle $\delta \leq 0.05$

Oscilloscope: rise time $t_r = 0.35$ ns

Fig 6. Reverse recovery time test circuit and waveforms

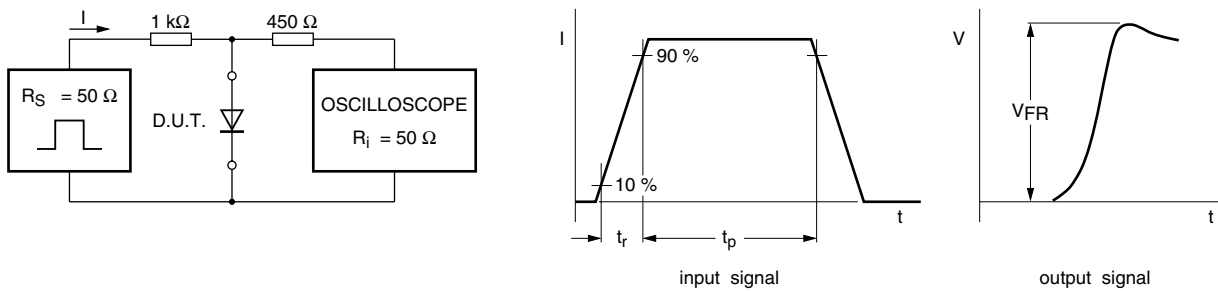

Input signal: forward pulse rise time $t_r = 20$ ns; forward current pulse duration $t_p \geq 100$ ns; duty cycle $\delta \leq 0.005$

Fig 7. Forward recovery voltage test circuit and waveforms

9. Package outline

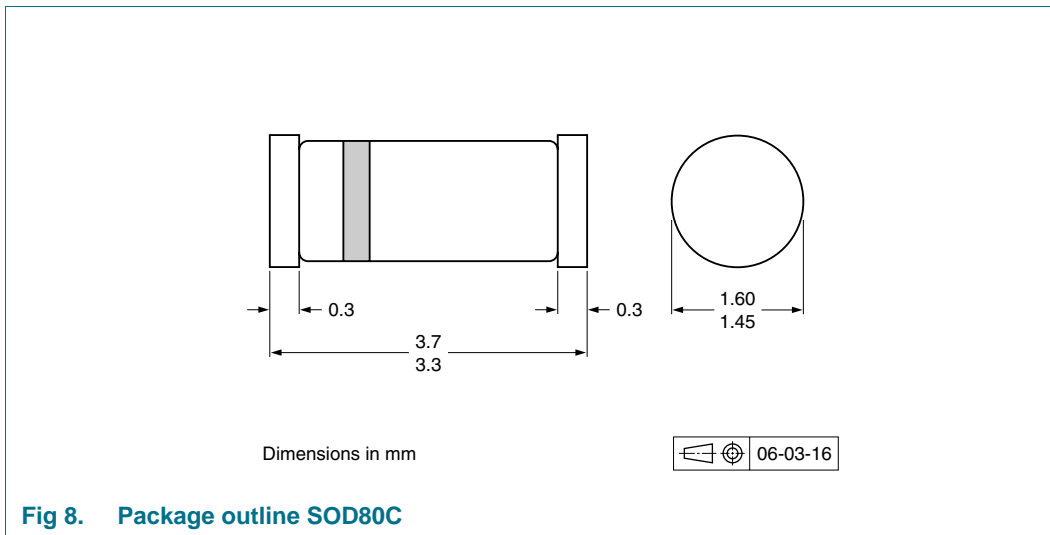

10. Packing information

Table 9. Packing methods

The indicated -xxx are the last three digits of the 12NC ordering code.^[1]

| Type number | Package | Description | Packing quantity | |
|-------------|---------|--------------------------------|------------------|-------|
| | | | 2500 | 10000 |
| PMLL4148L | SOD80C | 4 mm pitch, 8 mm tape and reel | -115 | -135 |
| PMLL4448 | | | | |

[1] For further information and the availability of packing methods, see [Section 14](#).

11. Soldering

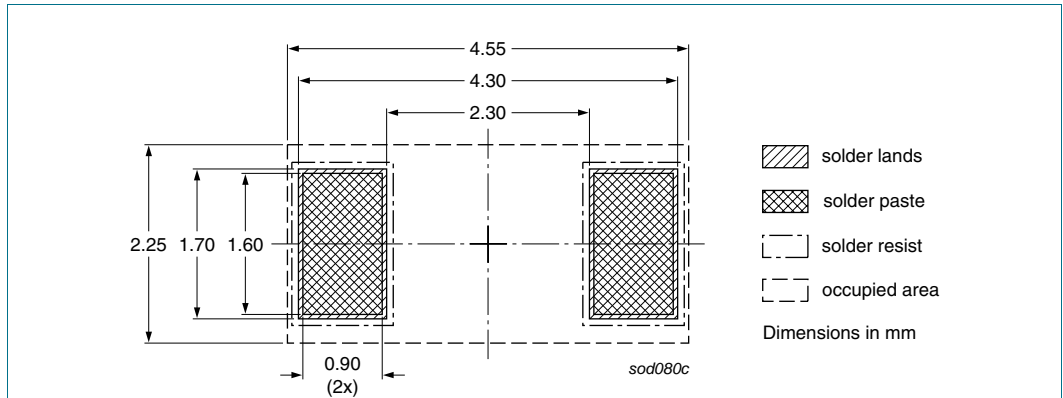

Fig 9. Reflow soldering footprint SOD80C

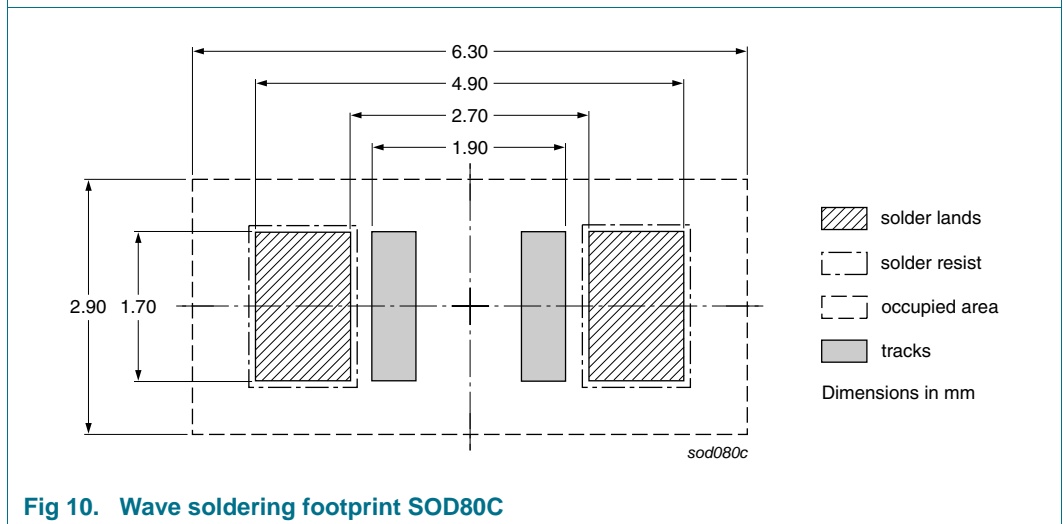

Fig 10. Wave soldering footprint SOD80C

12. Revision history

Table 10. Revision history

| Document ID | Release date | Data sheet status | Change notice | Supersedes |
|------------------------|--------------|---|---------------|------------------------|
| PMLL4148L_PMLL4448 v.8 | 20110201 | Product data sheet | - | PMLL4148L_PMLL4448 v.7 |
| Modifications: | | <ul style="list-style-type: none"> • Section 4 “Marking”: amended. • Figure 8: replaced by minimized outline drawing. • Section 13 “Legal information”: updated. | | |
| PMLL4148L_PMLL4448 v.7 | 20070131 | Product data sheet | - | PMLL4148L_PMLL4448 v.6 |
| PMLL4148L_PMLL4448 v.6 | 20050404 | Product data sheet | - | PMLL4148L_4448 v.5 |
| PMLL4148L_4448 v.5 | 20020123 | Product specification | - | PMLL4148L_4448 v.4 |
| PMLL4148L_4448 v.4 | 20001115 | Product specification | - | PMLL4148 v.3 |
| PMLL4148 v.3 | 19990527 | Product specification | - | PMLL4148 v.2 |
| PMLL4148 v.2 | 19960918 | Product specification | - | PMLL4148 v.1 |
| PMLL4148 v.1 | 19960423 | Product specification | - | - |

13. Legal information

13.1 Data sheet status

| Document status ^{[1][2]} | Product status ^[3] | Definition |
|-----------------------------------|-------------------------------|---|
| Objective [short] data sheet | Development | This document contains data from the objective specification for product development. |
| Preliminary [short] data sheet | Qualification | This document contains data from the preliminary specification. |
| Product [short] data sheet | Production | This document contains the product specification. |

[1] Please consult the most recently issued document before initiating or completing a design.

[2] The term 'short data sheet' is explained in section "Definitions".

[3] The product status of device(s) described in this document may have changed since this document was published and may differ in case of multiple devices. The latest product status information is available on the Internet at URL <http://www.nexperia.com>.

13.2 Definitions

Draft — The document is a draft version only. The content is still under internal review and subject to formal approval, which may result in modifications or additions. Nexperia does not give any representations or warranties as to the accuracy or completeness of information included herein and shall have no liability for the consequences of use of such information.

Short data sheet — A short data sheet is an extract from a full data sheet with the same product type number(s) and title. A short data sheet is intended for quick reference only and should not be relied upon to contain detailed and full information. For detailed and full information see the relevant full data sheet, which is available on request via the local Nexperia sales office. In case of any inconsistency or conflict with the short data sheet, the full data sheet shall prevail.

Product specification — The information and data provided in a Product data sheet shall define the specification of the product as agreed between Nexperia and its customer, unless Nexperia and customer have explicitly agreed otherwise in writing. In no event however, shall an agreement be valid in which the Nexperia product is deemed to offer functions and qualities beyond those described in the Product data sheet.

13.3 Disclaimers

Limited warranty and liability — Information in this document is believed to be accurate and reliable. However, Nexperia does not give any representations or warranties, expressed or implied, as to the accuracy or completeness of such information and shall have no liability for the consequences of use of such information.

In no event shall Nexperia be liable for any indirect, incidental, punitive, special or consequential damages (including - without limitation - lost profits, lost savings, business interruption, costs related to the removal or replacement of any products or rework charges) whether or not such damages are based on tort (including negligence), warranty, breach of contract or any other legal theory.

Notwithstanding any damages that customer might incur for any reason whatsoever, Nexperia's aggregate and cumulative liability towards customer for the products described herein shall be limited in accordance with the *Terms and conditions of commercial sale* of Nexperia.

Right to make changes — Nexperia reserves the right to make changes to information published in this document, including without limitation specifications and product descriptions, at any time and without notice. This document supersedes and replaces all information supplied prior to the publication hereof.

Suitability for use — Nexperia products are not designed, authorized or warranted to be suitable for use in life support, life-critical or safety-critical systems or equipment, nor in applications where failure or

malfunction of a Nexperia product can reasonably be expected to result in personal injury, death or severe property or environmental damage. Nexperia accepts no liability for inclusion and/or use of Nexperia products in such equipment or applications and therefore such inclusion and/or use is at the customer's own risk.

Applications — Applications that are described herein for any of these products are for illustrative purposes only. Nexperia makes no representation or warranty that such applications will be suitable for the specified use without further testing or modification.

Customers are responsible for the design and operation of their applications and products using Nexperia products, and Nexperia accepts no liability for any assistance with applications or customer product design. It is customer's sole responsibility to determine whether the Nexperia product is suitable and fit for the customer's applications and products planned, as well as for the planned application and use of customer's third party customer(s). Customers should provide appropriate design and operating safeguards to minimize the risks associated with their applications and products.

Nexperia does not accept any liability related to any default, damage, costs or problem which is based on any weakness or default in the customer's applications or products, or the application or use by customer's third party customer(s). Customer is responsible for doing all necessary testing for the customer's applications and products using Nexperia products in order to avoid a default of the applications and the products or of the application or use by customer's third party customer(s). Nexperia does not accept any liability in this respect.

Limiting values — Stress above one or more limiting values (as defined in the Absolute Maximum Ratings System of IEC 60134) will cause permanent damage to the device. Limiting values are stress ratings only and (proper) operation of the device at these or any other conditions above those given in the Recommended operating conditions section (if present) or the Characteristics sections of this document is not warranted. Constant or repeated exposure to limiting values will permanently and irreversibly affect the quality and reliability of the device.

Terms and conditions of commercial sale — Nexperia products are sold subject to the general terms and conditions of commercial sale, as published at <http://www.nexperia.com/profile/terms>, unless otherwise agreed in a valid written individual agreement. In case an individual agreement is concluded only the terms and conditions of the respective agreement shall apply. Nexperia hereby expressly objects to applying the customer's general terms and conditions with regard to the purchase of Nexperia products by customer.

No offer to sell or license — Nothing in this document may be interpreted or construed as an offer to sell products that is open for acceptance or the grant, conveyance or implication of any license under any copyrights, patents or other industrial or intellectual property rights.

Export control — This document as well as the item(s) described herein may be subject to export control regulations. Export might require a prior authorization from national authorities.

Quick reference data — The Quick reference data is an extract of the product data given in the Limiting values and Characteristics sections of this document, and as such is not complete, exhaustive or legally binding.

Non-automotive qualified products — Unless this data sheet expressly states that this specific Nexperia product is automotive qualified, the product is not suitable for automotive use. It is neither qualified nor tested in accordance with automotive testing or application requirements. Nexperia accepts no liability for inclusion and/or use of non-automotive qualified products in automotive equipment or applications.

In the event that customer uses the product for design-in and use in automotive applications to automotive specifications and standards, customer (a) shall use the product without Nexperia's warranty of the

product for such automotive applications, use and specifications, and (b) whenever customer uses the product for automotive applications beyond Nexperia's specifications such use shall be solely at customer's own risk, and (c) customer fully indemnifies Nexperia for any liability, damages or failed product claims resulting from customer design and use of the product for automotive applications beyond Nexperia's standard warranty and Nexperia's product specifications.

13.4 Trademarks

Notice: All referenced brands, product names, service names and trademarks are the property of their respective owners.

14. Contact information

For more information, please visit: <http://www.nexperia.com>



For sales office addresses, please send an email to: salesaddresses@nexperia.com

15. Contents

| | | |
|-----------|--|-----------|
| 1 | Product profile | 1 |
| 1.1 | General description | 1 |
| 1.2 | Features and benefits | 1 |
| 1.3 | Applications | 1 |
| 1.4 | Quick reference data | 1 |
| 2 | Pinning information | 2 |
| 3 | Ordering information | 2 |
| 4 | Marking | 2 |
| 5 | Limiting values | 2 |
| 6 | Thermal characteristics | 3 |
| 7 | Characteristics | 3 |
| 8 | Test information | 5 |
| 9 | Package outline | 6 |
| 10 | Packing information | 6 |
| 11 | Soldering | 7 |
| 12 | Revision history | 8 |
| 13 | Legal information | 9 |
| 13.1 | Data sheet status | 9 |
| 13.2 | Definitions | 9 |
| 13.3 | Disclaimers | 9 |
| 13.4 | Trademarks | 10 |
| 14 | Contact information | 10 |
| 15 | Contents | 11 |

Looking for pricing, stock, or lifecycle information?

Click below to explore more details on WIN SOURCE:

-  [View PMLL4148L,115 on WIN SOURCE](#)
-  [Nexperia USA Inc. Information](#)

Optimize Your Supply Chain with WIN SOURCE Solutions

-  Global Sourcing Solution
-  Obsolete Management
-  Cost Control Management
-  Shortage Management
-  Alternative Solution
-  Excess Inventory Management