



# THE DATASHEET OF T5V0DLP-7B



## Features

- 25 Watts Peak Pulse Power ( $t_p = 8 \times 20\mu s$ )
- IEC 61000-4-2 (ESD): Air - 15kV, Contact - 8kV
- IEC61000-4-4 (EFT): 40A 5/50ns
- Dual TVS for Protection of up to two Data Lines
- Low Capacitance (9pF typ), Suitable for USB2.0 Dataline Protection
- Subminiature, Low-Profile Package Suitable for Portable Applications—Case Outline of only 1.0mm x 0.6mm x 0.5mm
- **Totally Lead-Free & Fully RoHS Compliant (Notes 1 & 2)**
- **Halogen and Antimony Free. "Green" Device (Note 3)**

## Mechanical Data

- Case: X1-DFN1006-3
- Case Material: Molded Plastic, "Green" Molding Compound. UL Flammability Classification Rating 94V-0
- Moisture Sensitivity: Level 1 per J-STD-020
- Terminal Connections Indicator: Cathode Bar
- Terminals: Finish—NiPdAu over Copper Leadframe. Solderable per MIL-STD-202, Method 208 **(e4)**
- Weight: 0.0009 grams

X1-DFN1006-3

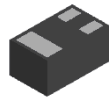

Bottom View

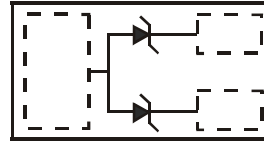

Device Schematic

## Ordering Information (Note 4)

Part Number	Case	Packaging
T5V0DLP-7B	X1-DFN1006-3	10,000/Tape & Reel

- Notes:
1. No purposely added lead. Fully EU Directive 2002/95/EC (RoHS), 2011/65/EU (RoHS 2) & 2015/863/EU (RoHS 3) compliant.
  2. See <https://www.diodes.com/quality/lead-free/> for more information about Diodes Incorporated's definitions of Halogen- and Antimony-free, "Green" and Lead-free.
  3. Halogen- and Antimony-free "Green" products are defined as those which contain <900ppm bromine, <900ppm chlorine (<1500ppm total Br + Cl) and <1000ppm antimony compounds.
  4. For packaging details, go to our website at <http://www.diodes.com/products/packages.html>.

## Marking Information



Bar Denotes Cathode Side

AB = Product Type Marking Code

## Thermal Characteristics

Characteristic	Symbol	Value	Unit
Peak Pulse Power ( $t_p = 8 \times 20\mu s$ ) (Note 5) $T_A = +25^\circ C$	$P_{pk}$	25	W
Power dissipation (Note 5) $T_A = +25^\circ C$	$P_D$	385	mW
Thermal Resistance, Junction to Ambient (Note 5) $T_A = +25^\circ C$	$R_{\theta JA}$	325	$^\circ C/W$
Operating and Storage Temperature Range	$T_J, T_{STG}$	-55 to +150	$^\circ C$

## Electrical Characteristics (@ $T_A = +25^\circ C$ , unless otherwise specified.)

Reverse Standoff Voltage	Breakdown Voltage $V_{BR}$ @ $I_T$		Test Current	Max. Reverse Leakage @ $V_{RWM}$ (Note 6)	Max. Clamping Voltage $V_C$ @ $I_{PP}$ (Note 7)		Max Total Capacitance $C_T$ (Note 8) $V_R = 1V$	Typical Total Capacitance $C_T$ (Note 8) $V_R = 3.3V$
	Min (V)	Max (V)			$I_T$ (mA)	$I_R$ ( $\mu A$ )		
5	6.1	8	1.0	0.25	12.5	2	9	5.4

- Notes:
5. Device mounted on FR-4 PC board with suggested pad layout, which can be found on our website at <http://www.diodes.com/datasheets/ap02001.pdf>.
  6. Short duration pulse test used to minimize self-heating effect.
  7. Clamping voltage value is based on an  $8 \times 20\mu s$  peak pulse current ( $I_{pp}$ ) waveform.
  8.  $f = 1MHz$

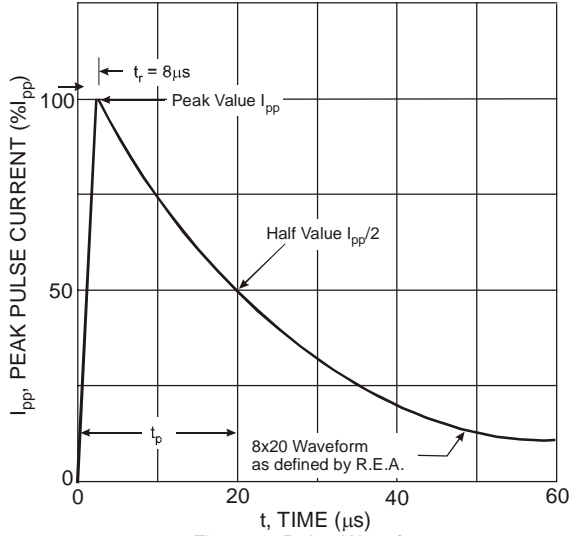

Figure 1 Pulse Waveform

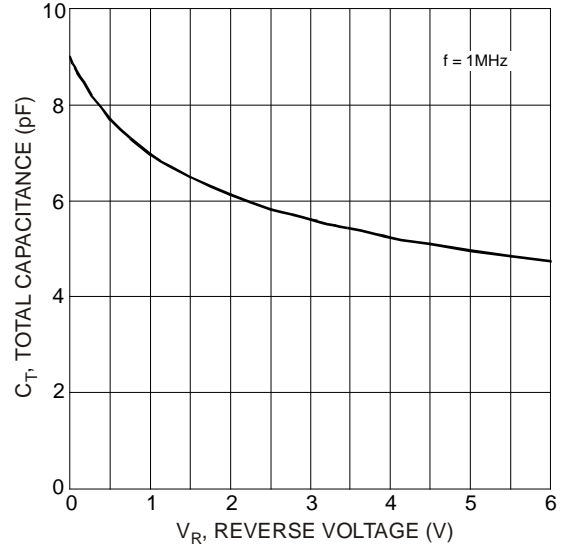

Figure 2 Total Capacitance

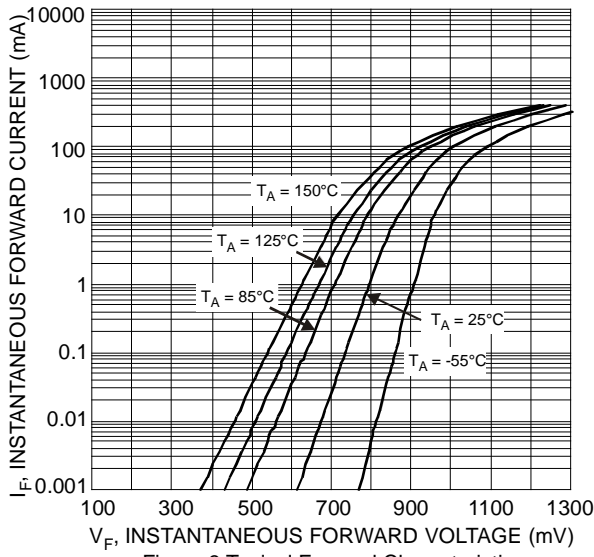

Figure 3 Typical Forward Characteristics

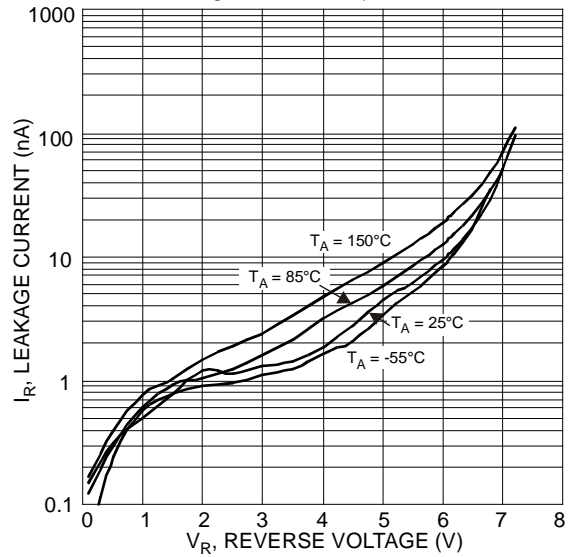

Figure 4 Typical Reverse Characteristics

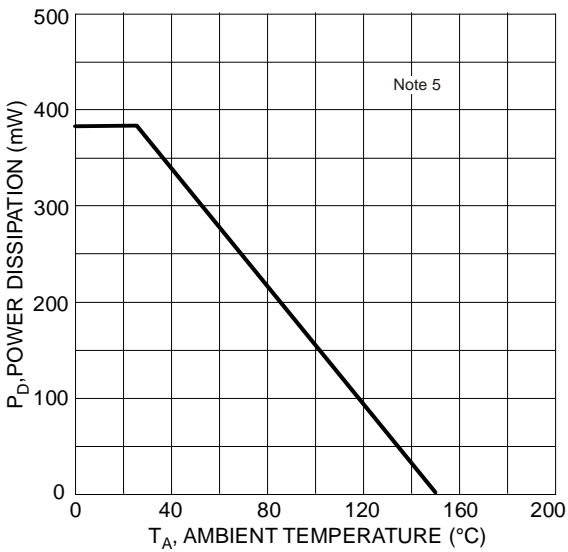
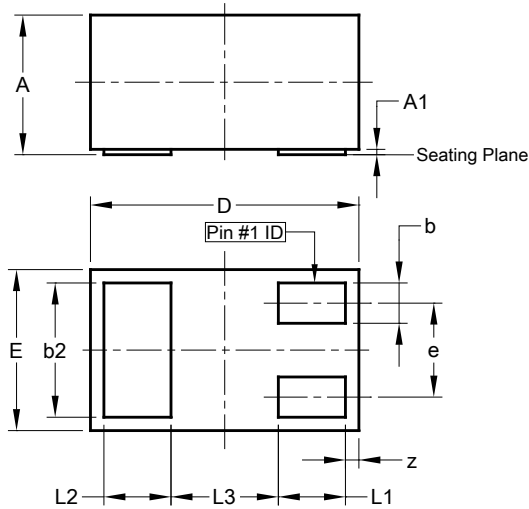

Figure 5 Power Derating Curve

**Package Outline Dimensions**

Please see <http://www.diodes.com/package-outlines.html> for the latest version.

**X1-DFN1006-3**



X1-DFN1006-3			
Dim	Min	Max	Typ
A	0.47	0.53	0.50
A1	0.00	0.05	0.03
b	0.10	0.20	0.15
b2	0.45	0.55	0.50
D	0.95	1.075	1.00
E	0.55	0.675	0.60
e	—	—	0.35
L1	0.20	0.30	0.25
L2	0.20	0.30	0.25
L3	—	—	0.40
z	0.02	0.08	0.05
<b>All Dimensions in mm</b>			

**Suggested Pad Layout**

Please see <http://www.diodes.com/package-outlines.html> for the latest version.

**X1-DFN1006-3**

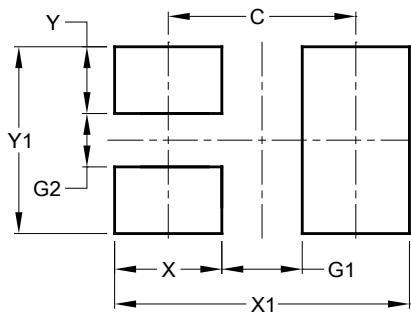

Dimensions	Value (in mm)
C	0.70
G1	0.30
G2	0.20
X	0.40
X1	1.10
Y	0.25
Y1	0.70

**IMPORTANT NOTICE**

DIODES INCORPORATED MAKES NO WARRANTY OF ANY KIND, EXPRESS OR IMPLIED, WITH REGARDS TO THIS DOCUMENT, INCLUDING, BUT NOT LIMITED TO, THE IMPLIED WARRANTIES OF MERCHANTABILITY AND FITNESS FOR A PARTICULAR PURPOSE (AND THEIR EQUIVALENTS UNDER THE LAWS OF ANY JURISDICTION).

Diodes Incorporated and its subsidiaries reserve the right to make modifications, enhancements, improvements, corrections or other changes without further notice to this document and any product described herein. Diodes Incorporated does not assume any liability arising out of the application or use of this document or any product described herein; neither does Diodes Incorporated convey any license under its patent or trademark rights, nor the rights of others. Any Customer or user of this document or products described herein in such applications shall assume all risks of such use and will agree to hold Diodes Incorporated and all the companies whose products are represented on Diodes Incorporated website, harmless against all damages.

Diodes Incorporated does not warrant or accept any liability whatsoever in respect of any products purchased through unauthorized sales channel. Should Customers purchase or use Diodes Incorporated products for any unintended or unauthorized application, Customers shall indemnify and hold Diodes Incorporated and its representatives harmless against all claims, damages, expenses, and attorney fees arising out of, directly or indirectly, any claim of personal injury or death associated with such unintended or unauthorized application.

Products described herein may be covered by one or more United States, international or foreign patents pending. Product names and markings noted herein may also be covered by one or more United States, international or foreign trademarks.

This document is written in English but may be translated into multiple languages for reference. Only the English version of this document is the final and determinative format released by Diodes Incorporated.

**LIFE SUPPORT**

Diodes Incorporated products are specifically not authorized for use as critical components in life support devices or systems without the express written approval of the Chief Executive Officer of Diodes Incorporated. As used herein:

A. Life support devices or systems are devices or systems which:

1. are intended to implant into the body, or
2. support or sustain life and whose failure to perform when properly used in accordance with instructions for use provided in the labeling can be reasonably expected to result in significant injury to the user.

B. A critical component is any component in a life support device or system whose failure to perform can be reasonably expected to cause the failure of the life support device or to affect its safety or effectiveness.



Customers represent that they have all necessary expertise in the safety and regulatory ramifications of their life support devices or systems, and acknowledge and agree that they are solely responsible for all legal, regulatory and safety-related requirements concerning their products and any use of Diodes Incorporated products in such safety-critical, life support devices or systems, notwithstanding any devices- or systems-related information or support that may be provided by Diodes Incorporated. Further, Customers must fully indemnify Diodes Incorporated and its representatives against any damages arising out of the use of Diodes Incorporated products in such safety-critical, life support devices or systems.

Copyright © 2019, Diodes Incorporated

[www.diodes.com](http://www.diodes.com)

## Looking for pricing, stock, or lifecycle information?

Click below to explore more details on WIN SOURCE:

-  [View T5V0DLP-7B on WIN SOURCE](#)
-  [Diodes Incorporated Information](#)

## Optimize Your Supply Chain with WIN SOURCE Solutions

-  Global Sourcing Solution
-  Obsolete Management
-  Cost Control Management
-  Shortage Management
-  Alternative Solution
-  Excess Inventory Management