



**THE DATASHEET OF
P3502SALRP**



TwinChip™ Series - DO-214



Agency Approvals

| Agency | Agency File Number |
|--------|--------------------|
| | E133083 |

Pinout Designation

NOT APPLICABLE

Schematic Symbol



Description

TwinChip™ Series DO-214 are very low capacitance SIDACtor® thyristors designed to protect broadband equipment such as VoIP, DSL modems and DSLAMs from damaging overvoltage transients. This series provides a surface mount solution that enables equipment to comply with global regulatory standards, while limiting the impact to broadband signals.

Features and Benefits

- Low voltage overshoot
- Low on-state voltage
- Does not degrade surge capability after multiple surge events within limit.
- Low distortion
- Fails short circuit when surged in excess of ratings
- 40% lower than comparable product
- RoHS Compliant and Halogen-Free
- Pb-free E3 means 2nd level interconnect is Pb-free and the terminal finish material is tin(Sn) (IPC/JEDEC J-STD-609A.01)

Applicable Global Standards

- TIA/968-A/B
- ITU K.20/21/45
- IEC 61000-4-5 2nd edition
- GR 1089 Intra-building
- YD/T 1082
- YD/T 993
- YD/T 950
- ITU K.20/21/45 Enhanced*
- GR 1089 Inter-building*

* Additional series resistance may be required to comply

Electrical Characteristics

| Part Number | Marking | V_{DRM} @ $I_{DRM}=5\mu A$ | V_s @ 100V/ μs | I_H | I_s | I_T | V_T @ $I_T=2.2$ Amps | @ 1MHz, 2V bias | |
|-------------|---------|---------------------------------|--------------------------|--------|--------|-------|---------------------------|-----------------|--------|
| | | V min | V max | mA min | mA max | A max | V max | pF min | pF max |
| P0642SALRP | P062A | 58 | 77 | 120 | 800 | 2.2 | 8 | 10 | 20 |
| P0722SALRP | P072A | 65 | 88 | 120 | 800 | 2.2 | 8 | 10 | 20 |
| P0902SALRP | P092A | 75 | 98 | 120 | 800 | 2.2 | 8 | 20 | 40 |
| P1102SALRP | P112A | 90 | 130 | 120 | 800 | 2.2 | 8 | 5 | 20 |
| P1302SALRP | P132A | 120 | 160 | 120 | 800 | 2.2 | 8 | 5 | 20 |
| P1502SALRP | P152A | 140 | 180 | 120 | 800 | 2.2 | 8 | 15 | 30 |
| P1802SALRP | P182A | 170 | 220 | 120 | 800 | 2.2 | 8 | 10 | 30 |
| P2302SALRP | P232A | 190 | 260 | 120 | 800 | 2.2 | 8 | 10 | 25 |
| P2602SALRP | P262A | 220 | 300 | 120 | 800 | 2.2 | 8 | 10 | 25 |
| P3002SALRP | P302A | 280 | 360 | 120 | 800 | 2.2 | 8 | 10 | 25 |
| P3502SALRP | P352A | 320 | 400 | 120 | 800 | 2.2 | 8 | 10 | 20 |
| P4202SALRP | P422A | 380 | 500 | 120 | 800 | 2.2 | 8 | 10 | 20 |
| P4802SALRP | P482A | 440 | 600 | 120 | 800 | 2.2 | 8 | 5 | 20 |
| P6002SALRP | P602A | 550 | 700 | 120 | 800 | 2.2 | 8 | 5 | 20 |

Table continues on next page.

Electrical Characteristics (continued)

| Part Number | Marking | V_{DRM} @ $I_{DRM}=5\mu A$ | V_S @ 100V/ μs | I_H | I_S | I_T | V_T @ $I_T=2.2 A$ | @ 1MHz, 2V bias | |
|-------------|---------|---------------------------------|--------------------------|--------|--------|-------|------------------------|-----------------|--------|
| | | V min | V max | mA min | mA max | A max | V max | pF min | pF max |
| P0642SBLRP | P062B | 58 | 77 | 120 | 800 | 2.2 | 8 | 10 | 20 |
| P0722SBLRP | P072B | 65 | 88 | 120 | 800 | 2.2 | 8 | 10 | 20 |
| P0902SBLRP | P092B | 75 | 98 | 120 | 800 | 2.2 | 8 | 5 | 20 |
| P1102SBLRP | P112B | 90 | 130 | 120 | 800 | 2.2 | 8 | 5 | 20 |
| P1302SBLRP | P132B | 120 | 160 | 120 | 800 | 2.2 | 8 | 15 | 30 |
| P1502SBLRP | P152B | 140 | 180 | 120 | 800 | 2.2 | 8 | 15 | 30 |
| P1802SBLRP | P182B | 170 | 220 | 120 | 800 | 2.2 | 8 | 10 | 30 |
| P2302SBLRP | P232B | 190 | 260 | 120 | 800 | 2.2 | 8 | 10 | 25 |
| P2602SBLRP | P262B | 220 | 300 | 120 | 800 | 2.2 | 8 | 10 | 25 |
| P3002SBLRP | P302B | 280 | 360 | 120 | 800 | 2.2 | 8 | 10 | 25 |
| P3502SBLRP | P352B | 320 | 400 | 120 | 800 | 2.2 | 8 | 10 | 20 |
| P4202SBLRP | P422B | 380 | 500 | 120 | 800 | 2.2 | 8 | 10 | 20 |
| P4802SBLRP | P482B | 440 | 600 | 120 | 800 | 2.2 | 8 | 5 | 20 |
| P6002SBLRP | P602B | 550 | 700 | 120 | 800 | 2.2 | 8 | 5 | 20 |
| P3002SCLRP | P302C | 280 | 360 | 120 | 800 | 2.2 | 8 | 20 | 35 |
| P3502SCLRP | P352C | 320 | 400 | 120 | 800 | 2.2 | 8 | 20 | 30 |
| P4202SCLRP | P422C | 380 | 500 | 120 | 800 | 2.2 | 8 | 15 | 30 |
| P4802SCLRP | P482C | 440 | 600 | 120 | 800 | 2.2 | 8 | 15 | 30 |
| P6002SCLRP | P602C | 550 | 700 | 120 | 800 | 2.2 | 8 | 10 | 25 |
| P7002SCLRP* | P702C | 640 | 850 | 120 | 800 | 2.2 | 8 | 10 | 30 |

- Notes:
- Absolute maximum ratings measured at $T_A=25^\circ C$ (unless otherwise noted).
 - Components are bi-directional.
 - Part with * is under development

Surge Ratings

| Series | I_{PP} | | | | | | | | | I_{TSM} 50/60 Hz | di/dt A/ μs |
|--------|--|--|--|--|--|--|--|--|---|-----------------------|---------------------|
| | 0.2/310 ¹ 0.5/700 ² | 2/10 ¹ 2/10 ² | 8/20 ¹ 1.2/50 ² | 10/160 ¹ 10/160 ² | 10/560 ¹ 10/560 ² | 5/320 ¹ 9/720 ² | 10/360 ¹ 10/360 ² | 10/1000 ¹ 10/1000 ² | 5/310 ¹ 10/700 ² | | |
| | A min | A min | A min | A min | A min | A min | A min | A min | A min | | |
| A | 20 | 150 | 150 | 90 | 50 | 75 | 75 | 45 | 75 | 20 | 500 |
| B | 25 | 250 | 250 | 150 | 100 | 100 | 125 | 80 | 100 | 25 | 500 |
| C | 50 | 500 | 400 | 200 | 150 | 200 | 175 | 100 | 200 | 30 | 500 |

- Notes:
- 1 Current waveform in μs
 - 2 Voltage waveform in μs
 - Peak pulse current rating (I_{PP}) is repetitive and guaranteed for the life of the product that remains in thermal equilibrium.
 - The component must initially be in thermal equilibrium with $-40^\circ C \leq T_J \leq +150^\circ C$

Additional Information



Datasheet



Resources



Samples

Thermal Considerations

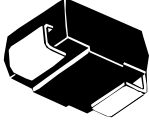
| Package | Symbol | Parameter | Value | Unit |
|---|-----------------|---|-------------|------|
| DO-214AA  | T_J | Operating Junction Temperature Range | -40 to +150 | °C |
| | T_S | Storage Temperature Range | -65 to +150 | °C |
| | $R_{\theta JA}$ | Thermal Resistance: Junction to Ambient | 90 | °C/W |

V-I Characteristics

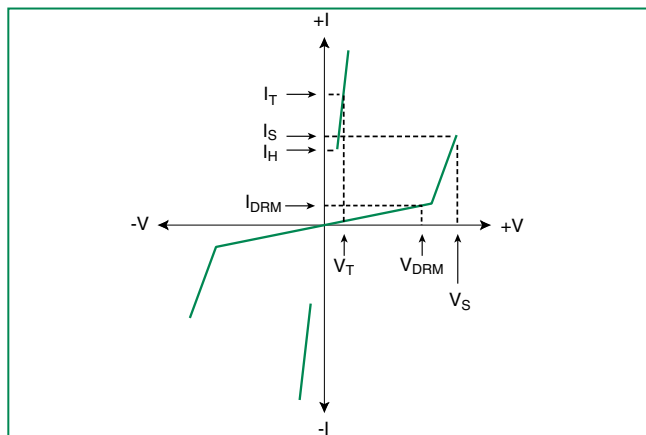

$t_r \times t_d$ Pulse Waveform

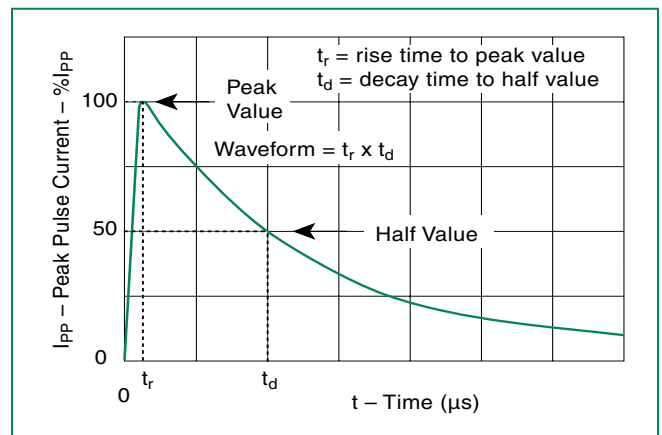

Normalized V_S Change vs. Junction Temperature

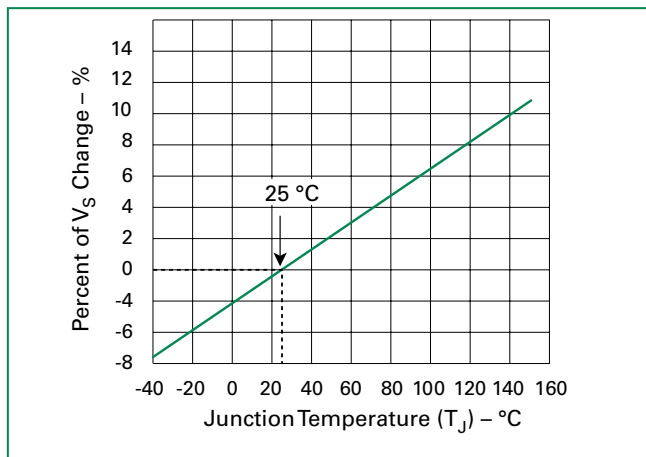

Normalized DC Holding Current vs. Case Temperature

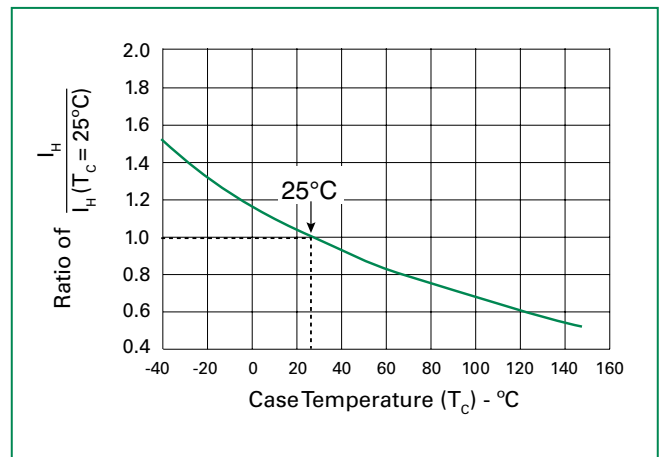

Soldering Parameters

| | | |
|--|-----------------------------------|-------------------------------|
| Reflow Condition | | Pb-Free assembly (see Fig. 1) |
| Pre Heat | -Temperature Min ($T_{s(min)}$) | +150°C |
| | -Temperature Max ($T_{s(max)}$) | +200°C |
| | -Time (Min to Max) (t_s) | 60-180 secs. |
| Average ramp up rate (Liquidus Temp (T_L) to peak) | | 3°C/sec. Max. |
| $T_{s(max)}$ to T_L - Ramp-up Rate | | 3°C/sec. Max. |
| Reflow | -Temperature (T_L) (Liquidus) | +217°C |
| | -Temperature (t_L) | 60-150 secs. |
| Peak Temp (T_p) | | +260(+0/-5)°C |
| Time within 5°C of actual Peak Temp (t_p) | | 30 secs. Max. |
| Ramp-down Rate | | 6°C/sec. Max. |
| Time 25°C to Peak Temp (T_p) | | 8 min. Max. |
| Do not exceed | | +260°C |

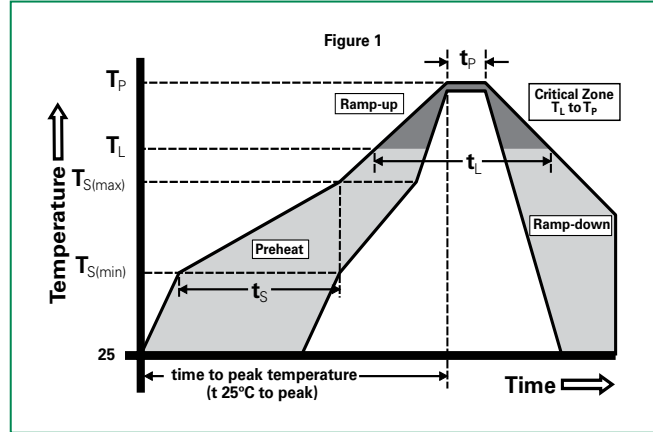

Physical Specifications

| | |
|------------------------|--|
| Lead Material | Copper Alloy |
| Terminal Finish | 100% Matte-Tin Plated |
| Body Material | UL Recognized compound meeting flammability rating V-0 |

Part Marking

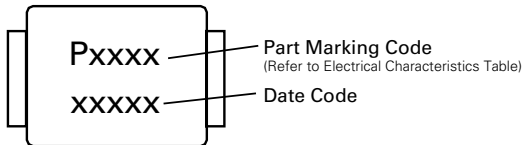

Environmental Specifications

| | |
|---|--|
| High Temp Voltage Blocking | 80% Rated V_{DRM} ($V_{AC Peak}$) +125°C or +150°C, 504 or 1008 hrs. MIL-STD-750 (Method 1040) JEDEC, JESD22-A-101 |
| Temp Cycling | -65°C to +150°C, 15 min. dwell, 10 up to 100 cycles. MIL-STD-750 (Method 1051) EIA/JEDEC, JESD22-A104 |
| Biased Temp & Humidity | 52 V_{DC} (+85°C) 85%RH, 504 up to 1008 hrs. EIA/JEDEC, JESD22-A-101 |
| High Temp Storage | +150°C 1008 hrs. MIL-STD-750 (Method 1031) JEDEC, JESD22-A-101 |
| Low Temp Storage | -65°C, 1008 hrs. |
| Thermal Shock | 0°C to +100°C, 5 min. dwell, 10 sec. transfer, 10 cycles. MIL-STD-750 (Method 1056) JEDEC, JESD22-A-106 |
| Autoclave (Pressure Cooker Test) | +121°C, 100%RH, 2atm, 24 up to 168 hrs. EIA/JEDEC, JESD22-A-102 |
| Resistance to Solder Heat | +260°C, 30 secs. MIL-STD-750 (Method 2031) |
| Moisture Sensitivity Level | 85%RH, +85°C, 168 hrs., 3 reflow cycles (+260°C Peak). JEDEC-J-STD-020, Level 1 |

Dimensions — DO-214AA

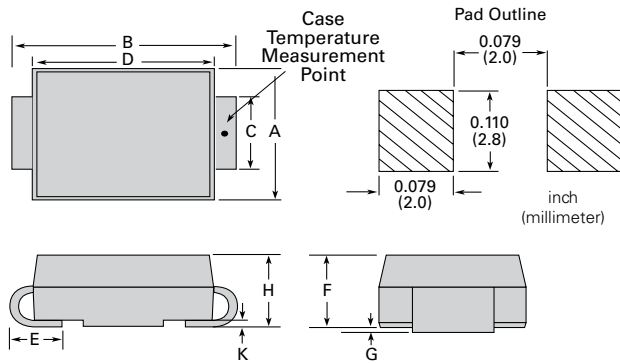

| Dimensions | Inches | | Millimeters | |
|------------|--------|-------|-------------|------|
| | Min | Max | Min | Max |
| A | 0.130 | 0.156 | 3.30 | 3.95 |
| B | 0.201 | 0.220 | 5.10 | 5.60 |
| C | 0.077 | 0.087 | 1.95 | 2.20 |
| D | 0.159 | 0.181 | 4.05 | 4.60 |
| E | 0.030 | 0.063 | 0.75 | 1.60 |
| F | 0.075 | 0.096 | 1.90 | 2.45 |
| G | 0.002 | 0.008 | 0.05 | 0.20 |
| H | 0.077 | 0.104 | 1.95 | 2.65 |
| K | 0.006 | 0.016 | 0.15 | 0.41 |

Part Numbering

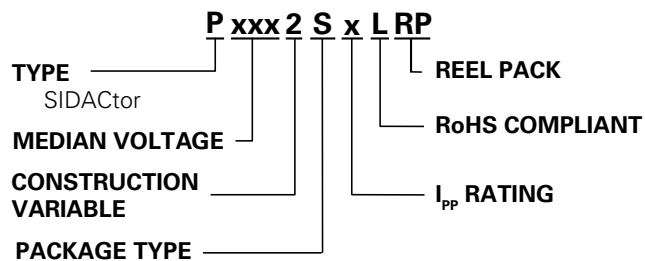

Packing Options

| Package Type | Description | Quantity | Added Suffix | Industry Standard |
|--------------|----------------------|----------|--------------|-------------------|
| S | DO-214AA Tape & Reel | 2500 | RP | EIA-481-D |

Tape and Reel Specification — DO-214AA

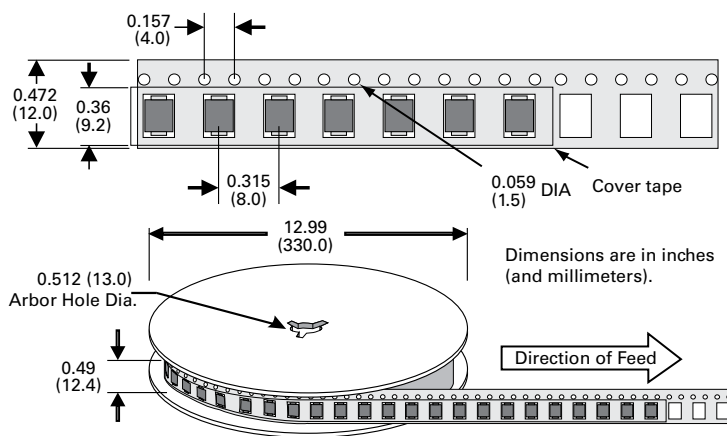

Disclaimer Notice - Information furnished is believed to be accurate and reliable. However, users should independently evaluate the suitability of and test each product selected for their own applications. Littelfuse products are not designed for, and may not be used in, all applications. Read complete Disclaimer Notice at www.littelfuse.com/disclaimer-electronics.

Looking for pricing, stock, or lifecycle information?

Click below to explore more details on WIN SOURCE:

 [View P3502SALRP on WIN SOURCE](#)

 [Littelfuse Inc. Information](#)

Optimize Your Supply Chain with WIN SOURCE Solutions

-  Global Sourcing Solution
-  Obsolete Management
-  Cost Control Management
-  Shortage Management
-  Alternative Solution
-  Excess Inventory Management