



**THE DATASHEET OF  
AD5314ARMZ-REEL7**





### FEATURES

**AD5304:** 4 buffered 8-Bit DACs in 10-lead MSOP and 10-lead LFCSP

**A, W Version:**  $\pm 1$  LSB INL, **B Version:**  $\pm 0.625$  LSB INL

**AD5314:** 4 buffered 10-Bit DACs in 10-lead MSOP and 10-lead LFCSP

**A, W Version:**  $\pm 4$  LSB INL, **B Version:**  $\pm 2.5$  LSB INL

**AD5324:** 4 buffered 12-Bit DACs in 10-lead MSOP and 10-lead LFCSP

**A, W Version:**  $\pm 16$  LSB INL, **B Version:**  $\pm 10$  LSB INL

**Low power operation:** 500  $\mu$ A @ 3 V, 600  $\mu$ A @ 5 V

**2.5 V to 5.5 V power supply**

**Guaranteed monotonic by design over all codes**

**Power-down to 80 nA @ 3 V, 200 nA @ 5 V**

**Double-buffered input logic**

**Output range: 0 V to  $V_{REF}$**

**Power-on reset to 0 V**

**Simultaneous update of outputs ( $\overline{LDAC}$  function)**

**Low power-, SPI<sup>®</sup>-, QSPI<sup>™</sup>-, MICROWIRE<sup>™</sup>-, and DSP-compatible 3-wire serial interface**

**On-chip, rail-to-rail output buffer amplifiers**

**Temperature range  $-40^{\circ}\text{C}$  to  $+105^{\circ}\text{C}$**

**Qualified for automotive applications**

### APPLICATIONS

Portable battery-powered instruments

Digital gain and offset adjustment

Programmable voltage and current sources

Programmable attenuators

Industrial process controls

### GENERAL DESCRIPTION

The AD5304/AD5314/AD5324<sup>1</sup> are quad 8-, 10-, and 12-bit buffered voltage output DACs in 10-lead MSOP and 10-lead LFCSP packages that operate from a single 2.5 V to 5.5 V supply, consuming 500  $\mu$ A at 3 V. Their on-chip output amplifiers allow rail-to-rail output swing to be achieved with a slew rate of 0.7 V/ $\mu$ s. A 3-wire serial interface is used; it operates at clock rates up to 30 MHz and is compatible with standard SPI, QSPI, MICROWIRE, and DSP interface standards.

The references for the four DACs are derived from one reference pin. The outputs of all DACs can be updated simultaneously using the software  $\overline{LDAC}$  function. The parts incorporate a power-on reset circuit, and ensure that the DAC outputs power up to 0 V and remains there until a valid write takes place to the device. The parts contain a power-down feature that reduces the current consumption of the device to 200 nA @ 5 V (80 nA @ 3 V).

The low power consumption of these parts in normal operation makes them ideally suited to portable battery-operated equipment. The power consumption is 3 mW at 5 V, 1.5 mW at 3 V, reducing to 1  $\mu$ W in power-down mode.

<sup>1</sup> Protected by U.S. Patent No. 5,969,657.

### FUNCTIONAL BLOCK DIAGRAM

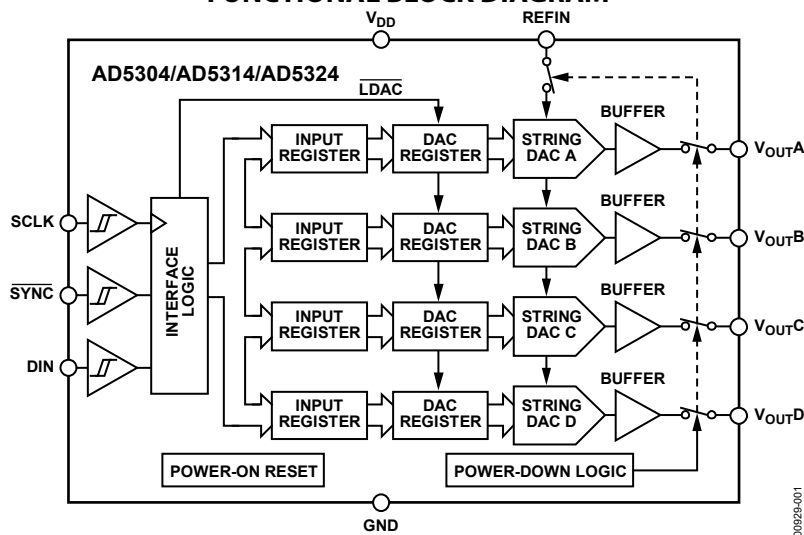

Figure 1.

Rev. J

[Document Feedback](#)

Information furnished by Analog Devices is believed to be accurate and reliable. However, no responsibility is assumed by Analog Devices for its use, nor for any infringements of patents or other rights of third parties that may result from its use. Specifications subject to change without notice. No license is granted by implication or otherwise under any patent or patent rights of Analog Devices. Trademarks and registered trademarks are the property of their respective owners.

## TABLE OF CONTENTS

Features .....	1
Applications .....	1
General Description .....	1
Functional Block Diagram .....	1
Revision History .....	2
Specifications .....	3
AC Characteristics .....	4
Timing Characteristics .....	5
Absolute Maximum Ratings .....	6
ESD Caution .....	6
Pin Configurations and Function Descriptions .....	7
Typical Performance Characteristics .....	8
Terminology .....	12

## REVISION HISTORY

### 6/2019—Rev. I to Rev. J

Changes to Table 1 .....	3
Changes to Table 4 .....	6
Updated Outline Dimensions .....	22
Changes to Ordering Guide .....	23

### 5/2017—Rev. H to Rev. I

Changes to Figure 4 .....	7
Changes to Address and Control Bits Section .....	15
Updated Outline Dimensions .....	22
Changes to Ordering Guide .....	23

### 9/2011—Rev. G to Rev. H

Changes to Table 4 .....	6
--------------------------	---

### 5/2011—Rev. F to Rev. G

Added W Version .....	Universal
Added EPAD Notation to Figure 4 .....	7
Updated Outline Dimensions .....	22
Changes to Ordering Guide .....	23
Added Automotive Products Section .....	23

Theory of Operation .....	14
Functional Description .....	14
Power-On Reset .....	14
Serial Interface .....	14
Power-Down Mode .....	16
Microprocessor Interfacing .....	16
Applications Information .....	18
Typical Application Circuit .....	18
Decoding Multiple AD5304/AD5314/AD5324s .....	19
Power Supply Bypassing and Grounding .....	20
Outline Dimensions .....	22
Ordering Guide .....	23
Automotive Products .....	23

### 9/2006—Rev. E to Rev. F

Updated Format .....	Universal
Changes to Specifications Section .....	3
Changes to Table 5 .....	7
Updated Outline Dimensions .....	22
Changes to Ordering Guide .....	23

### 5/2005—Rev. D to Rev. E

Added 10-lead LFCSP package .....	Universal
Changes to Title .....	1
Changes to Ordering Guide .....	4

### 8/2003—Rev. C to Rev. D

Added A Version .....	Universal
Changes to Features .....	1
Changes to Specifications .....	2
Changes to Absolute Maximum Ratings .....	4
Changes to Ordering Guide .....	4
Changes to Figure 6 .....	11
Added OCTALS Section to Table 2 .....	15
Updated Outline Dimensions .....	16

## SPECIFICATIONS

$V_{DD} = 2.5\text{ V to }5.5\text{ V}$ ;  $V_{REF} = 2\text{ V}$ ;  $R_L = 2\text{ k}\Omega$  to GND;  $C_L = 200\text{ pF}$  to GND; all specifications  $T_{MIN}$  to  $T_{MAX}$ , unless otherwise noted.

Table 1.

Parameter <sup>1</sup>	A, W Version <sup>2</sup>			B Version <sup>2</sup>			Unit	Test Conditions/Comments
	Min	Typ	Max	Min	Typ	Max		
DC PERFORMANCE <sup>3,4</sup>								
AD5304								
Resolution		8			8		Bits	Guaranteed monotonic by design over all codes
Relative Accuracy		$\pm 0.15$	$\pm 1$		$\pm 0.15$	$\pm 0.625$	LSB	
Differential Nonlinearity		$\pm 0.02$	$\pm 0.25$		$\pm 0.02$	$\pm 0.25$	LSB	
AD5314								
Resolution		10			10		Bits	Guaranteed monotonic by design over all codes
Relative Accuracy		$\pm 0.5$	$\pm 4$		$\pm 0.5$	$\pm 2.5$	LSB	
Differential Nonlinearity		$\pm 0.05$	$\pm 0.5$		$\pm 0.05$	$\pm 0.5$	LSB	
AD5324								
Resolution		12			12		Bits	Guaranteed monotonic by design over all codes
Relative Accuracy		$\pm 2$	$\pm 16$		$\pm 2$	$\pm 10$	LSB	
Differential Nonlinearity		$\pm 0.2$	$\pm 1$		$\pm 0.2$	$\pm 1$	LSB	
Offset Error		$\pm 0.4$	$\pm 3$		$\pm 0.4$	$\pm 3$	% of FSR	See Figure 13 and Figure 14
Gain Error		$\pm 0.15$	$\pm 1$		$\pm 0.15$	$\pm 1$	% of FSR	See Figure 13 and Figure 14
Lower Dead Band		20	60		20	60	mV	Lower dead band exists only if offset error is negative
Offset Error Drift <sup>5</sup>		-12			-12		ppm of FSR/ $^{\circ}\text{C}$	
Gain Error Drift <sup>5</sup>		-5			-5		ppm of FSR/ $^{\circ}\text{C}$	
DC Power Supply Rejection Ratio <sup>5</sup>		-60			-60		dB	$\Delta V_{DD} = \pm 10\%$
DC Crosstalk <sup>5</sup>		200			200		$\mu\text{V}$	$R_L = 2\text{ k}\Omega$ to GND or $V_{DD}$
DAC REFERENCE INPUTS <sup>5</sup>								
$V_{REF}$ Input Range	0.25		$V_{DD}$	0.25		$V_{DD}$	V	
$V_{REF}$ Input Impedance	37	45		37	45		k $\Omega$	Normal operation
		>10			>10		M $\Omega$	Power-down mode
Reference Feedthrough		-90			-90		dB	Frequency = 10 kHz
OUTPUT CHARACTERISTICS <sup>5</sup>								
Minimum Output Voltage <sup>6</sup>		0.001			0.001		V	Measurement of the minimum and maximum
Maximum Output Voltage <sup>6</sup>		$V_{DD} - 0.001$			$V_{DD} - 0.001$			V drive capability of the output amplifier
DC Output Impedance		0.5			0.5		$\Omega$	
Short Circuit Current		25			25		mA	$V_{DD} = 5\text{ V}$
		16			16		mA	$V_{DD} = 3\text{ V}$
Power-Up Time		2.5			2.5		$\mu\text{s}$	Coming out of power-down mode $V_{DD} = 5\text{ V}$
		5			5		$\mu\text{s}$	Coming out of power-down mode $V_{DD} = 3\text{ V}$

Parameter <sup>1</sup>	A, W Version <sup>2</sup>			B Version <sup>2</sup>			Unit	Test Conditions/Comments
	Min	Typ	Max	Min	Typ	Max		
LOGIC INPUTS <sup>5</sup>								
Input Current			±1			±1	μA	
V <sub>IL</sub> , Input Low Voltage			0.8			0.8	V	V <sub>DD</sub> = 5 V ± 10%
			0.6			0.6	V	V <sub>DD</sub> = 3 V ± 10%
			0.5			0.5	V	V <sub>DD</sub> = 2.5 V
V <sub>IH</sub> , Input High Voltage	2.4			2.4			V	V <sub>DD</sub> = 5 V ± 10%
	2.1			2.1			V	V <sub>DD</sub> = 3 V ± 10%
	2.0			2.0			V	V <sub>DD</sub> = 2.5 V
Pin Capacitance		3			3		pF	
POWER REQUIREMENTS								
V <sub>DD</sub>	2.5		5.5	2.5		5.5	V	
I <sub>DD</sub> (Normal Mode) <sup>7</sup>								
V <sub>DD</sub> = 4.5 V to 5.5 V		600	900	600	900		μA	V <sub>IH</sub> = V <sub>DD</sub> and V <sub>IL</sub> = GND
V <sub>DD</sub> = 2.5 V to 3.6 V		500	700	500	700		μA	V <sub>IH</sub> = V <sub>DD</sub> and V <sub>IL</sub> = GND
I <sub>DD</sub> (Power-Down Mode)								
V <sub>DD</sub> = 4.5 V to 5.5 V		0.2	1	0.2	1		μA	V <sub>IH</sub> = V <sub>DD</sub> and V <sub>IL</sub> = GND
V <sub>DD</sub> = 2.5 V to 3.6 V		0.08	1	0.08	1		μA	V <sub>IH</sub> = V <sub>DD</sub> and V <sub>IL</sub> = GND

<sup>1</sup> See the Terminology section.

<sup>2</sup> Temperature range (A, B, W Version): -40°C to +105°C; typical at +25°C.

<sup>3</sup> DC specifications tested with the outputs unloaded.

<sup>4</sup> Linearity is tested using a reduced code range: AD5304 (Code 8 to Code 248); AD5314 (Code 28 to Code 995); AD5324 (Code 115 to Code 3981).

<sup>5</sup> Guaranteed by design and characterization, not production tested.

<sup>6</sup> For the amplifier output to reach its minimum voltage, offset error must be negative. For the amplifier output to reach its maximum voltage, V<sub>REF</sub> = V<sub>DD</sub> and offset plus gain error must be positive.

<sup>7</sup> I<sub>DD</sub> specification is valid for all DAC codes; interface inactive; all DACs active; load currents excluded.

## AC CHARACTERISTICS

V<sub>DD</sub> = 2.5 V to 5.5 V; R<sub>L</sub> = 2 kΩ to GND; C<sub>L</sub> = 200 pF to GND; all specifications T<sub>MIN</sub> to T<sub>MAX</sub>, unless otherwise noted.

Table 2.

Parameter <sup>1,2</sup>	A, B, W Version <sup>3</sup>			Unit	Test Conditions/Comments
	Min	Typ	Max		
Output Voltage Settling Time					V <sub>REF</sub> = V <sub>DD</sub> = 5 V
AD5304		6	8	μs	¼ scale to ¾ scale change (0x40 to 0xC0)
AD5314		7	9	μs	¼ scale to ¾ scale change (0x100 to 0x300)
AD5324		8	10	μs	¼ scale to ¾ scale change (0x400 to 0xC00)
Slew Rate		0.7		V/μs	
Major-Code Transition Glitch Energy		12		nV-sec	1 LSB change around major carry
Digital Feedthrough		1		nV-sec	
Digital Crosstalk		1		nV-sec	
DAC-to-DAC Crosstalk		3		nV-sec	
Multiplying Bandwidth		200		kHz	V <sub>REF</sub> = 2 V ± 0.1 V p-p
Total Harmonic Distortion		-70		dB	V <sub>REF</sub> = 2.5 V ± 0.1 V p-p; frequency = 10 kHz

<sup>1</sup> See the Terminology section.

<sup>2</sup> Guaranteed by design and characterization, not production tested.

<sup>3</sup> Temperature range (A, B, W Version): -40°C to +105°C; typical at +25°C.

**TIMING CHARACTERISTICS**

$V_{DD} = 2.5\text{ V to }5.5\text{ V}$ ; all specifications  $T_{MIN}$  to  $T_{MAX}$ , unless otherwise noted.

Table 3.

Parameter <sup>1, 2, 3</sup>	Limit at $T_{MIN}, T_{MAX}$		Unit	Test Conditions/Comments
	$V_{DD} = 2.5\text{ V to }3.6\text{ V}$	$V_{DD} = 3.6\text{ V to }5.5\text{ V}$		
$t_1$	40	33	ns min	SCLK cycle time
$t_2$	16	13	ns min	SCLK high time
$t_3$	16	13	ns min	SCLK low time
$t_4$	16	13	ns min	$\overline{\text{SYNC}}$ to SCLK falling edge setup time
$t_5$	5	5	ns min	Data setup time
$t_6$	4.5	4.5	ns min	Data hold time
$t_7$	0	0	ns min	SCLK falling edge to $\overline{\text{SYNC}}$ rising edge
$t_8$	80	33	ns min	Minimum $\overline{\text{SYNC}}$ high time

<sup>1</sup> Guaranteed by design and characterization, not production tested.

<sup>2</sup> All input signals are specified with  $t_r = t_f = 5\text{ ns}$  (10% to 90% of  $V_{DD}$ ) and timed from a voltage level of  $(V_{IL} + V_{IH})/2$ .

<sup>3</sup> See Figure 2.

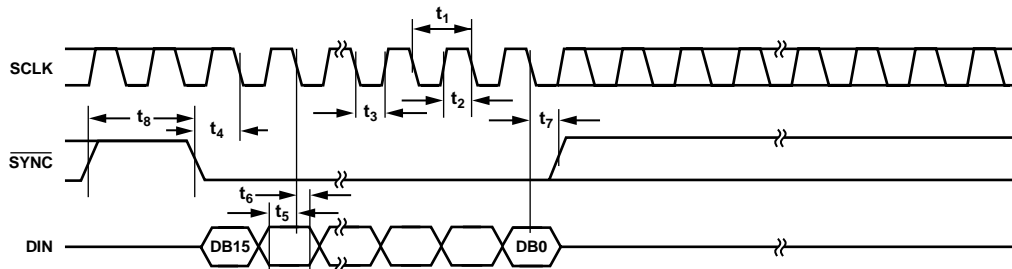

Figure 2. Serial Interface Timing Diagram

200-02680

## ABSOLUTE MAXIMUM RATINGS

$T_A = 25^\circ\text{C}$ , unless otherwise noted.

Table 4.

Parameter <sup>1</sup>	Rating
$V_{DD}$ to GND	-0.3 V to +7 V
Digital Input Voltage to GND	-0.3 V to $V_{DD} + 0.3$ V
Reference Input Voltage to GND	-0.3 V to $V_{DD} + 0.3$ V
$V_{OUTA}$ through $V_{OUTD}$ to GND	-0.3 V to $V_{DD} + 0.3$ V
Operating Temperature Range	
Industrial (A, B, W Version)	-40°C to +105°C
Storage Temperature Range	-65°C to +150°C
Junction Temperature ( $T_J$ max)	150°C
10-Lead MSOP	
Power Dissipation	$(T_J \text{ max} - T_A) / \theta_{JA}$
$\theta_{JA}$ Thermal Impedance	206°C/W
$\theta_{JC}$ Thermal Impedance	44°C/W
10-Lead LFCSP	
Power Dissipation	$(T_J \text{ max} - T_A) / \theta_{JA}$
$\theta_{JA}$ Thermal Impedance	84°C/W
Reflow Soldering	
Peak Temperature (Pb-free)	260°C
Time at Peak Temperature	10 sec to 40 sec

<sup>1</sup> Transient currents of up to 100 mA do not cause SCR latch-up.

Stresses at or above those listed under Absolute Maximum Ratings may cause permanent damage to the product. This is a stress rating only; functional operation of the product at these or any other conditions above those indicated in the operational section of this specification is not implied. Operation beyond the maximum operating conditions for extended periods may affect product reliability.

### ESD CAUTION



**ESD (electrostatic discharge) sensitive device.** Charged devices and circuit boards can discharge without detection. Although this product features patented or proprietary protection circuitry, damage may occur on devices subjected to high energy ESD. Therefore, proper ESD precautions should be taken to avoid performance degradation or loss of functionality.

## PIN CONFIGURATIONS AND FUNCTION DESCRIPTIONS

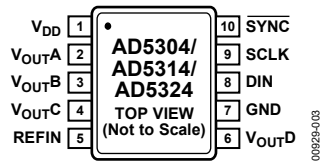
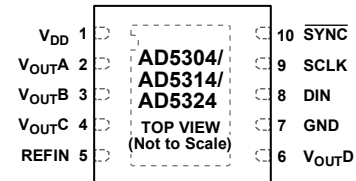

Figure 3. 10-Lead MSOP Pin Configuration



NOTES  
 1. THE EXPOSED PAD IS THE GROUND REFERENCE POINT FOR ALL CIRCUITRY ON THE PART. IT CAN BE CONNECTED TO 0V OR LEFT UNCONNECTED PROVIDED THERE IS A CONNECTION TO 0V VIA THE GND PIN.

Figure 4. 10-Lead LFCSP Pin Configuration

Table 5. Pin Function Descriptions

Pin No.	Mnemonic	Description
1	V <sub>DD</sub>	Power Supply Input. These parts can be operated from 2.5 V to 5.5 V and the supply can be decoupled to GND.
2	V <sub>OUTA</sub>	Buffered Analog Output Voltage from DAC A. The output amplifier has rail-to-rail operation.
3	V <sub>OUTB</sub>	Buffered Analog Output Voltage from DAC B. The output amplifier has rail-to-rail operation.
4	V <sub>OUTC</sub>	Buffered Analog Output Voltage from DAC C. The output amplifier has rail-to-rail operation.
5	REFIN	Reference Input Pin for All Four DACs. It has an input range from 0.25 V to V <sub>DD</sub> .
6	V <sub>OUTD</sub>	Buffered Analog Output Voltage from DAC D. The output amplifier has rail-to-rail operation.
7	GND	Ground Reference Point for All Circuitry on the Part.
8	DIN	Serial Data Input. This device has a 16-bit shift register. Data is clocked into the register on the falling edge of the serial clock input. The DIN input buffer is powered down after each write cycle.
9	SCLK	Serial Clock Input. Data is clocked into the input shift register on the falling edge of the serial clock input. Data can be transferred at clock speeds up to 30 MHz. The SCLK input buffer is powered down after each write cycle.
10	$\overline{\text{SYNC}}$	Active Low Control Input. This is the frame synchronization signal for the input data. When $\overline{\text{SYNC}}$ goes low, it enables the input shift register and data is transferred in on the falling edges of the following 16 clocks. If $\overline{\text{SYNC}}$ is taken high before the 16 <sup>th</sup> falling edge of SCLK, the rising edge of $\overline{\text{SYNC}}$ acts as an interrupt and the write sequence is ignored by the device.
	Exposed Paddle <sup>1</sup>	Ground Reference Point for All Circuitry on the Part. Can be connected to 0 V or left unconnected provided there is a connection to 0 V via the GND pin.

<sup>1</sup> For the 10-Lead LFCSP only.

TYPICAL PERFORMANCE CHARACTERISTICS



Figure 5. AD5304 Typical INL Plot



Figure 8. AD5304 Typical DNL Plot

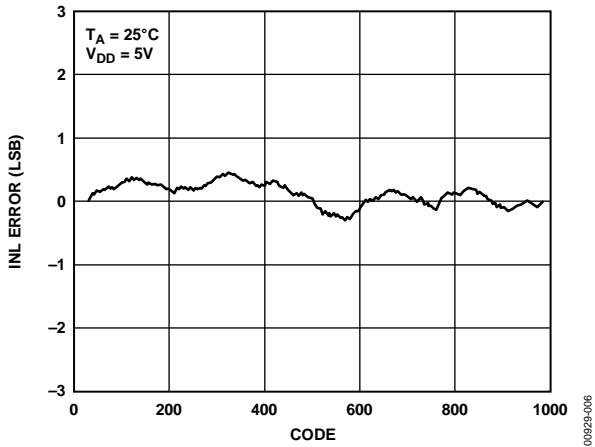

Figure 6. AD5314 Typical INL Plot

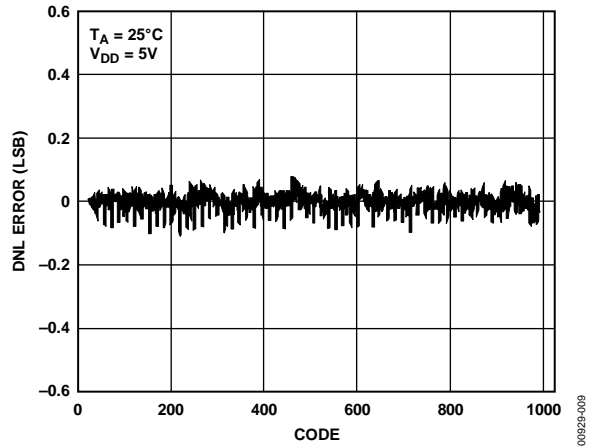

Figure 9. AD5314 Typical DNL Plot

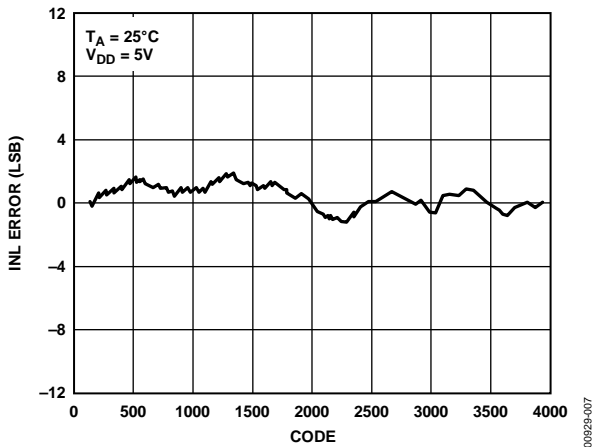

Figure 7. AD5324 Typical INL Plot

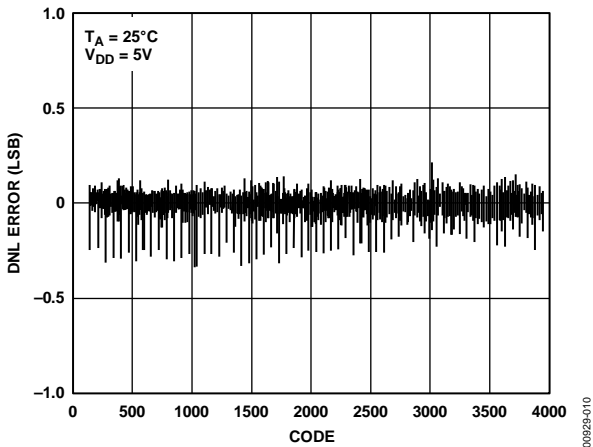

Figure 10. AD5324 Typical DNL Plot



Figure 11. AD5304 INL and DNL Error vs.  $V_{REF}$

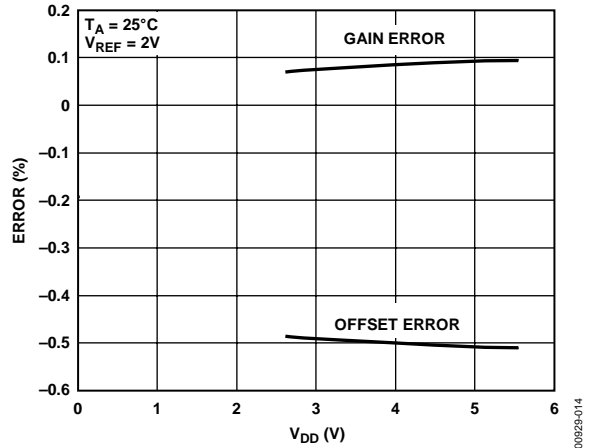

Figure 14. Offset Error and Gain Error vs.  $V_{DD}$

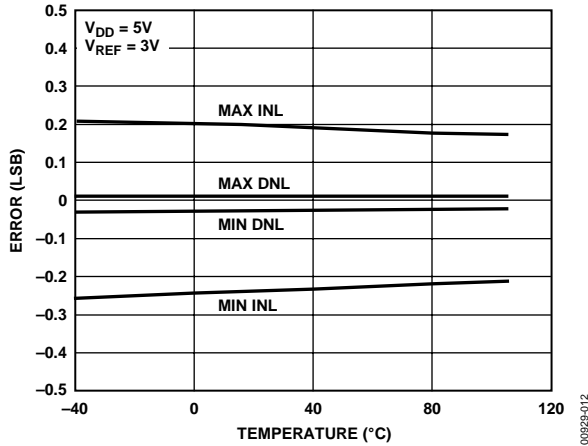

Figure 12. AD5304 INL Error and DNL Error vs. Temperature

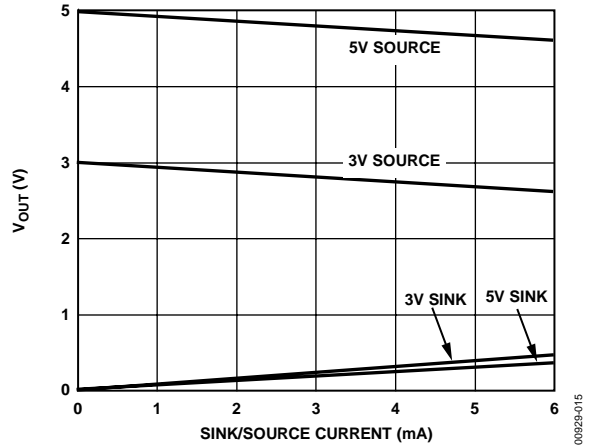

Figure 15.  $V_{out}$  Source and Sink Current Capability



Figure 13. AD5304 Offset Error and Gain Error vs. Temperature

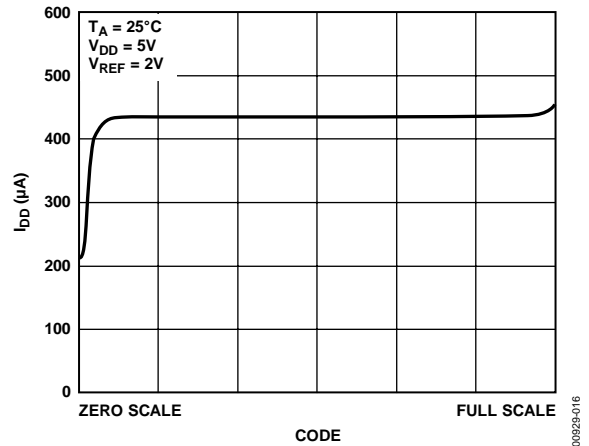

Figure 16. Supply Current vs. DAC Code

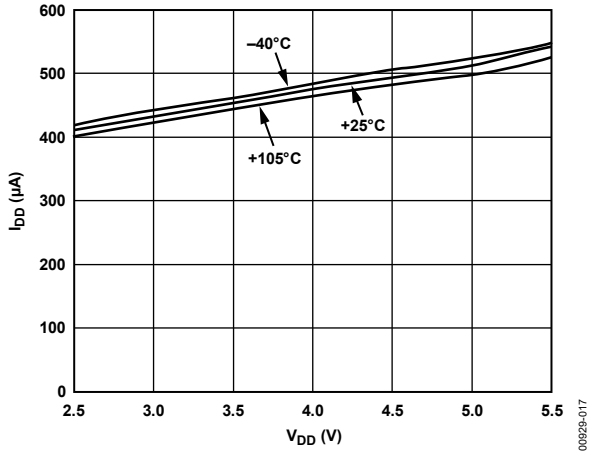

Figure 17. Supply Current vs. Supply Voltage

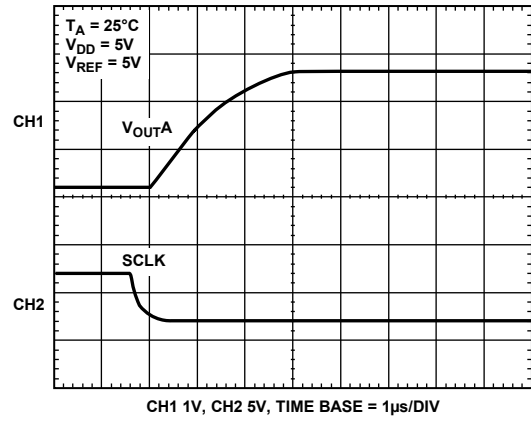

Figure 20. Half-Scale Settling (1/4 to 3/4 Scale Code Change)

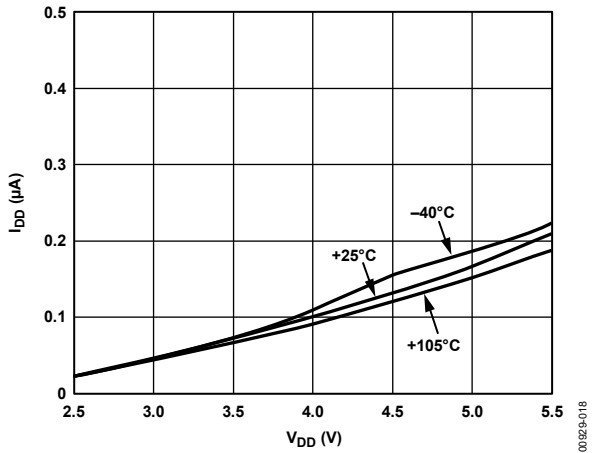

Figure 18. Power-Down Current vs. Supply Voltage

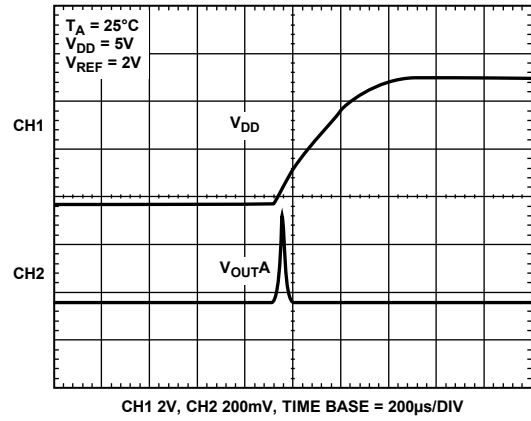

Figure 21. Power-On Reset to 0 V

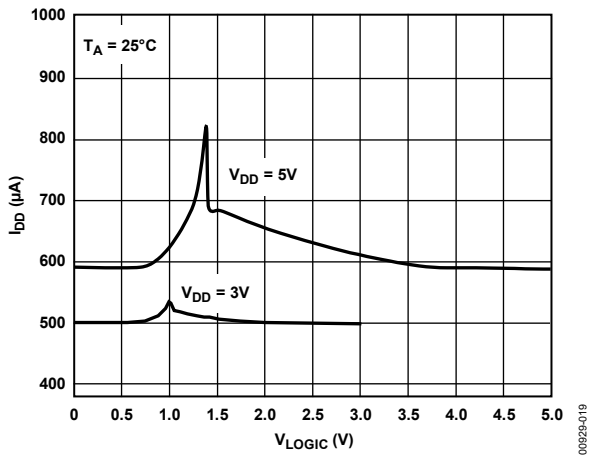

Figure 19. Supply Current vs. Logic Input Voltage



Figure 22. Exiting Power-Down to Midscale

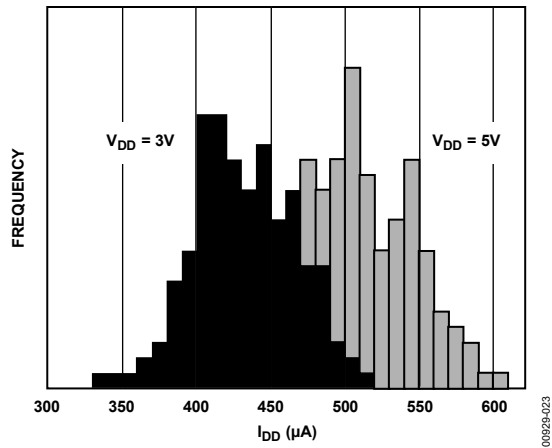

Figure 23.  $I_{DD}$  Histogram with  $V_{DD} = 3\text{ V}$  and  $V_{DD} = 5\text{ V}$

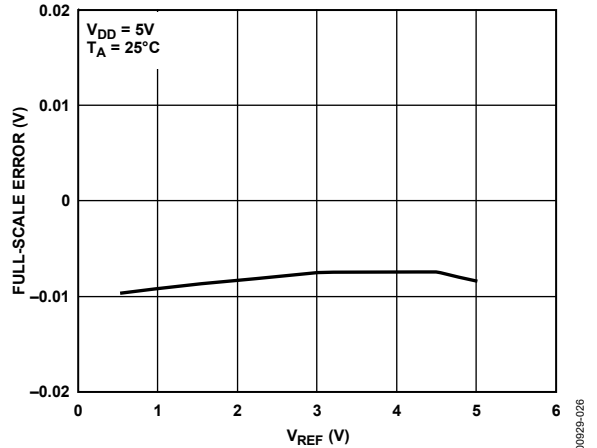

Figure 26. Full-Scale Error vs.  $V_{REF}$

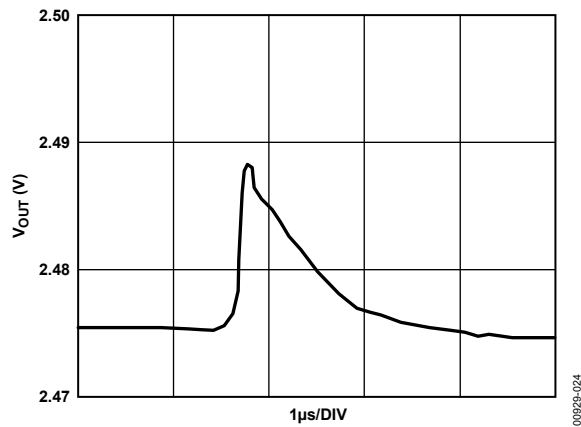

Figure 24. AD5324 Major-Code Transition Glitch Energy

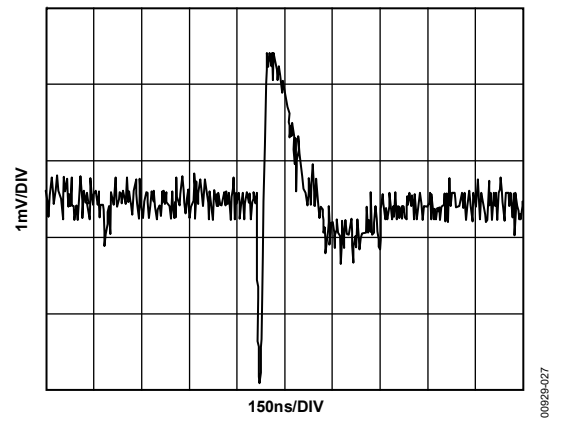

Figure 27. DAC-to-DAC Crosstalk



Figure 25. Multiplying Bandwidth (Small-Signal Frequency Response)

## TERMINOLOGY

### Relative Accuracy or Integral Nonlinearity (INL)

For the DAC, relative accuracy or integral nonlinearity (INL) is a measure of the maximum deviation, in LSB, from a straight line passing through the endpoints of the DAC transfer function. Typical INL vs. code plots can be seen in Figure 5, Figure 6, and Figure 7.

### Differential Nonlinearity

Differential nonlinearity (DNL) is the difference between the measured change and the ideal 1 LSB change between any two adjacent codes. A specified differential nonlinearity of  $\pm 1$  LSB maximum ensures monotonicity. This DAC is guaranteed monotonic by design. Typical DNL vs. code plots can be seen in Figure 8, Figure 9, and Figure 10.

### Offset Error

This is a measure of the offset error of the DAC and the output amplifier. It is expressed as a percentage of the full-scale range.

### Gain Error

This is a measure of the span error of the DAC. It is the deviation in slope of the actual DAC transfer characteristic from the ideal expressed as a percentage of the full-scale range.

### Offset Error Drift

This is a measure of the change in offset error with changes in temperature. It is expressed in (ppm of full-scale range)/ $^{\circ}\text{C}$ .

### Gain Error Drift

This is a measure of the change in gain error with changes in temperature. It is expressed in (ppm of full-scale range)/ $^{\circ}\text{C}$ .

### Power Supply Rejection Ratio (PSRR)

This indicates how the output of the DAC is affected by changes in the supply voltage. PSRR is the ratio of the change in  $V_{\text{OUT}}$  to a change in  $V_{\text{DD}}$  for full-scale output of the DAC. It is measured in decibels.  $V_{\text{REF}}$  is held at 2 V and  $V_{\text{DD}}$  is varied  $\pm 10\%$ .

### DC Crosstalk

This is the dc change in the output level of one DAC at midscale in response to a full-scale code change (all 0s to all 1s and vice versa) and output change of another DAC. It is expressed in microvolts.

### Reference Feedthrough

This is the ratio of the amplitude of the signal at the DAC output to the reference input when the DAC output is not being updated. It is expressed in decibels.

### Major-Code Transition Glitch Energy

Major-code transition glitch energy is the energy of the impulse injected into the analog output when the code in the DAC register changes state. It is normally specified as the area of the glitch in nV-s and is measured when the digital code is changed by 1 LSB at the major carry transition (011 . . . 11 to 100 . . . 00 or 100 . . . 00 to 011 . . . 11).

### Digital Feedthrough

Digital feedthrough is a measure of the impulse injected into the analog output of the DAC from the digital input pins of the device when the DAC output is not being written to ( $\overline{\text{SYNC}}$  held high). It is specified in nV-s and is measured with a worst-case change on the digital input pins (for example, from all 0s to all 1s or vice versa.)

### Digital Crosstalk

This is the glitch impulse transferred to the output of one DAC at midscale in response to a full-scale code change (all 0s to all 1s and vice versa) in the input register of another DAC. It is expressed in nV-s.

### DAC-to-DAC Crosstalk

This is the glitch impulse transferred to the output of one DAC due to a digital code change and subsequent output change of another DAC. This includes both digital and analog crosstalk. It is measured by loading one of the DACs with a full-scale code change (all 0s to all 1s and vice versa) with the  $\overline{\text{LDAC}}$  bit set low and monitoring the output of another DAC. The energy of the glitch is expressed in nV-s.

### Multiplying Bandwidth

The amplifiers within the DAC have a finite bandwidth. The multiplying bandwidth is a measure of this. A sine wave on the reference (with full-scale code loaded to the DAC) appears on the output. The multiplying bandwidth is the frequency at which the output amplitude falls to 3 dB below the input.

### Total Harmonic Distortion (THD)

This is the difference between an ideal sine wave and its attenuated version using the DAC. The sine wave is used as the reference for the DAC and the THD is a measure of the harmonics present on the DAC output. It is measured in decibels.

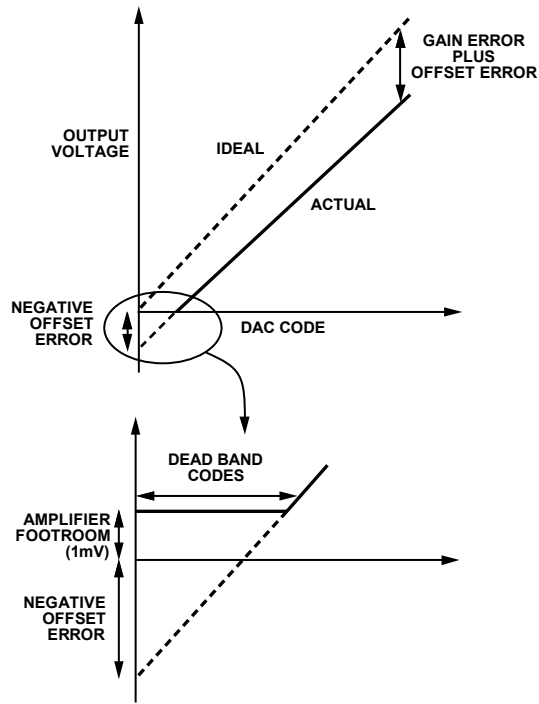

Figure 28. Transfer Function with Negative Offset

01829-028

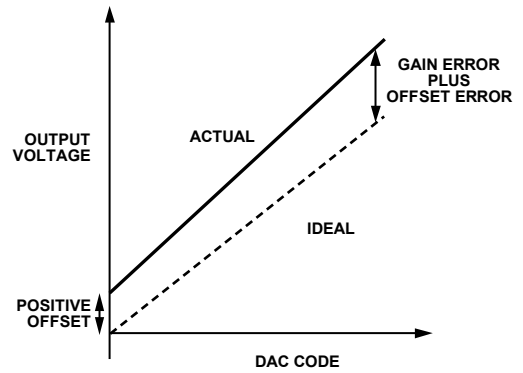

Figure 29. Transfer Function with Positive Offset

01829-029

## THEORY OF OPERATION

### FUNCTIONAL DESCRIPTION

The AD5304/AD5314/AD5324 are quad, resistor-string DACs fabricated on a CMOS process with resolutions of 8, 10, and 12 bits, respectively. Each contains four output buffer amplifiers and is written to via a 3-wire serial interface. They operate from single supplies of 2.5 V to 5.5 V, and the output buffer amplifiers provide rail-to-rail output swing with a slew rate of 0.7 V/ $\mu$ s. The four DACs share a single reference input pin. The devices have programmable power-down modes, in which all DACs can be turned off completely with a high impedance output.

### Digital-to-Analog

The architecture of one DAC channel consists of a resistor-string DAC followed by an output buffer amplifier. The voltage at the REFIN pin provides the reference voltage for the DAC. Figure 30 shows a block diagram of the DAC architecture. Since the input coding to the DAC is straight binary, the ideal output voltage is given by

$$V_{OUT} = \frac{V_{REF} \times D}{2^N}$$

where

$D$  = decimal equivalent of the binary code that is loaded to the DAC register:

- 0–255 for AD5304 (8 bits)
- 0–1023 for AD5314 (10 bits)
- 0–4095 for AD5324 (12 bits)

$N$  = DAC resolution.



Figure 30. DAC Channel Architecture

### Resistor String

The resistor string section is shown in Figure 31. It is simply a string of resistors, each of value  $R$ . The digital code loaded to the DAC register determines at which node on the string the voltage is tapped off to be fed into the output amplifier. The voltage is tapped off by closing one of the switches connecting the string to the amplifier. Because it is a string of resistors, it is guaranteed monotonic.

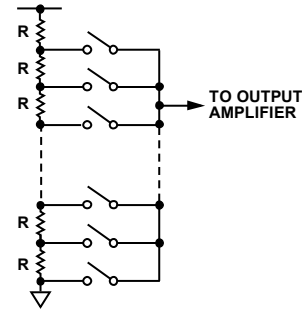

Figure 31. Resistor String

### DAC Reference Inputs

There is a single reference input pin for the four DACs. The reference input is not buffered. The user can have a reference voltage as low as 0.25 V or as high as  $V_{DD}$  because there is no restriction due to the headroom or footroom requirements of any reference amplifier. It is recommended to use a buffered reference in the external circuit (for example, REF192). The input impedance is typically 45 k $\Omega$ .

### Output Amplifier

The output buffer amplifier is capable of generating rail-to-rail voltages on its output, giving an output range of 0 V to  $V_{DD}$  when the reference is  $V_{DD}$ . It is capable of driving a load of 2 k $\Omega$  to GND or  $V_{DD}$ , in parallel with 500 pF to GND or  $V_{DD}$ . The source and sink capabilities of the output amplifier can be seen in the plot in Figure 15.

The slew rate is 0.7 V/ $\mu$ s with a half-scale settling time to  $\pm 0.5$  LSB (at eight bits) of 6  $\mu$ s.

### POWER-ON RESET

The AD5304/AD5314/AD5324 are provided with a power-on reset function, so that they power up in a defined state. The power-on state uses normal operation and an output voltage set to 0 V.

Both input and DAC registers are filled with zeros and remain so until a valid write sequence is made to the device. This is particularly useful in applications where it is important to know the state of the DAC outputs while the device is powering up.

### SERIAL INTERFACE

The AD5304/AD5314/AD5324 are controlled over a versatile, 3-wire serial interface that operates at clock rates up to 30 MHz and are compatible with SPI, QSPI, MICROWIRE, and DSP interface standards.



Figure 32. AD5304 Input Shift Register Contents

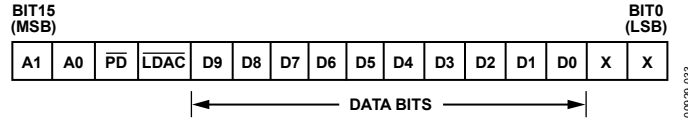

Figure 33. AD5314 Input Shift Register Contents



Figure 34. AD5324 Input Shift Register Contents

**Input Shift Register**

The input shift register is 16 bits wide. Data is loaded into the device as a 16-bit word under the control of a serial clock input, SCLK. See Figure 2 for the timing diagram of this operation. The 16-bit word consists of four control bits followed by 8, 10, or 12 bits of DAC data, depending on the device type. Data is loaded MSB first (Bit 15) and the first two bits determine whether the data is for DAC A, DAC B, DAC C, or DAC D. Bit 13 and Bit 12 control the operating mode of the DAC. Bit 13 is  $\overline{PD}$ , and determines whether the part is in normal or power-down mode. Bit 12 is  $\overline{LDAC}$ , and controls when DAC registers and outputs are updated.

**Table 6. Address Bits**

A1	A0	DAC Addressed
0	0	DAC A
0	1	DAC B
1	0	DAC C
1	1	DAC D

**Address and Control Bits**

- $\overline{PD}$  0: All four DACs go into power-down mode, consuming only 200 nA at 5 V. The DAC outputs enter a high impedance state.  
1: Normal operation.
- $\overline{LDAC}$  0: All four DAC registers and, therefore, all DAC outputs updated simultaneously on completion of the write sequence.  
1: Only addressed input register is updated. There is no change in the content of the DAC registers.

It is not recommended to set the  $\overline{PD}$  and  $\overline{LDAC}$  control bits simultaneously. Depending on the SPI transmission rate, this causes the data transferred to be loaded into the DAC register if the  $\overline{LDAC}$  control bit was previously set.

The AD5324 uses all 12 bits of DAC data; the AD5314 uses 10 bits and ignores the 2 LSB Bits. The AD5304 uses eight bits and ignores

the last four bits. The data format is straight binary, with all 0s corresponding to 0 V output and all 1s corresponding to full-scale output ( $V_{REF} - 1 \text{ LSB}$ ).

The  $\overline{SYNC}$  input is a level-triggered input that acts as a frame synchronization signal and chip enable. Data can be transferred into the device only while  $\overline{SYNC}$  is low. To start the serial data transfer, take  $\overline{SYNC}$  low, observing the minimum  $\overline{SYNC}$  to SCLK falling edge setup time,  $t_4$ . After  $\overline{SYNC}$  goes low, serial data shifts into the device’s input shift register on the falling edges of SCLK for 16 clock pulses. Any data and clock pulses after the 16<sup>th</sup> falling edge of SCLK are ignored because the SCLK and DIN input buffers are powered down. No further serial data transfer occurs until  $\overline{SYNC}$  is taken high and low again.

$\overline{SYNC}$  can be taken high after the falling edge of the 16<sup>th</sup> SCLK pulse, observing the minimum SCLK falling edge to  $\overline{SYNC}$  rising edge time,  $t_7$ .

After the end of the serial data transfer, data automatically transfers from the input shift register to the input register of the selected DAC. If  $\overline{SYNC}$  is taken high before the 16<sup>th</sup> falling edge of SCLK, the data transfer is aborted and the DAC input registers are not updated.

When data has been transferred into three of the DAC input registers, all DAC registers and all DAC outputs are simultaneously updated by setting  $\overline{LDAC}$  low when writing to the remaining DAC input register.

**Low Power Serial Interface**

To reduce the power consumption of the device even further, the interface fully powers up only when the device is being written to, that is, on the falling edge of  $\overline{SYNC}$ . As soon as the 16-bit control word has been written to the part, the SCLK and DIN input buffers are powered down. They power up again only following a falling edge of  $\overline{SYNC}$ .

### Double-Buffered Interface

The AD5304/AD5314/AD5324 DACs have double-buffered interfaces consisting of two banks of registers—input registers and DAC registers. The input register is directly connected to the input shift register and the digital code is transferred to the relevant input register on completion of a valid write sequence. The DAC register contains the digital code used by the resistor string.

Access to the DAC register is controlled by the  $\overline{\text{LDAC}}$  bit. When the  $\overline{\text{LDAC}}$  bit is set high, the DAC register is latched and hence the input register can change state without affecting the contents of the DAC register. However, when the  $\overline{\text{LDAC}}$  bit is set low, all DAC registers are updated after a complete write sequence.

This is useful if the user requires simultaneous updating of all DAC outputs. The user can write to three of the input registers individually and then, by setting the  $\overline{\text{LDAC}}$  bit low when writing to the remaining DAC input register, all outputs update simultaneously.

These parts contain an extra feature whereby the DAC register is not updated unless its input register has been updated since the last time that  $\overline{\text{LDAC}}$  was brought low. Normally, when  $\overline{\text{LDAC}}$  is brought low, the DAC registers are filled with the contents of the input registers. In the case of the AD5304/AD5314/AD5324, the part updates the DAC register only if the input register has been changed since the last time the DAC register was updated, thereby removing unnecessary digital crosstalk.

### POWER-DOWN MODE

The AD5304/AD5314/AD5324 have low power consumption, dissipating only 1.5 mW with a 3 V supply and 3 mW with a 5 V supply. Power consumption can be further reduced when the DACs are not in use by putting them into power-down mode, selected by a 0 on Bit 13 ( $\overline{\text{PD}}$ ) of the control word.

When the  $\overline{\text{PD}}$  bit is set to 1, all DACs work normally with a typical power consumption of 600  $\mu\text{A}$  at 5 V (500  $\mu\text{A}$  at 3 V). However, in power-down mode, the supply current falls to 200 nA at 5 V (80 nA at 3 V) when all DACs are powered down. Not only does the supply current drop, but also the output stage is internally switched from the output of the amplifier, making it open-circuit. This has the advantage that the output is three-stated while the part is in power-down mode, and provides a defined input condition for whatever is connected to the output of the DAC amplifier. The output stage is illustrated in Figure 35.

The bias generator, the output amplifier, the resistor string, and all other associated linear circuitry are shut down when the power-down mode is activated. However, the contents of the registers are unaffected when in power-down. The time to exit power-down is typically 2.5  $\mu\text{s}$  for  $V_{\text{DD}} = 5 \text{ V}$  and 5  $\mu\text{s}$  when  $V_{\text{DD}} = 3 \text{ V}$ . This is the time from the falling edge of the 16<sup>th</sup> SCLK pulse to when the output voltage deviates from its power down voltage. See Figure 22 for a plot.

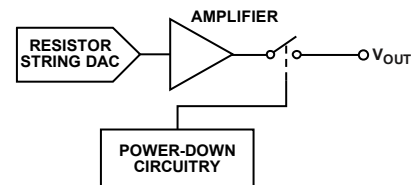

Figure 35. Output Stage during Power-Down

## MICROPROCESSOR INTERFACING

### AD5304/AD5314/AD5324 to ADSP-21xx

Figure 36 shows a serial interface between the AD5304/AD5314/AD5324 and the ADSP-21xx family. The ADSP-21xx is set up to operate in the SPORT transmit alternate framing mode. The ADSP-21xx sport is programmed through the SPORT control register and must be configured as follows: internal clock operation, active-low framing, and 16-bit word length. Transmission is initiated by writing a word to the Tx register after the SPORT has been enabled. The data is clocked out on each rising edge of the DSP's serial clock and clocked into the AD5304/AD5314/AD5324 on the falling edge of the DAC's SCLK.



\*ADDITIONAL PINS OMITTED FOR CLARITY.

Figure 36. AD5304/AD5314/AD5324 to ADSP-21xx Interface

**AD5304/AD5314/AD5324 to 68HC11/68L11 Interface**

Figure 37 shows a serial interface between the AD5304/AD5314/AD5324 and the 68HC11/68L11 microcontroller. SCK of the 68HC11/68L11 drives the SCLK of the AD5304/AD5314/AD5324, while the MOSI output drives the serial data line (DIN) of the DAC. The SYNC signal is derived from a port line (PC7). The setup conditions for the correct operation of this interface are as follows: the 68HC11/68L11 is configured so that its CPOL bit is a 0 and its CPHA bit is a 1. When data is being transmitted to the DAC, the SYNC line is taken low (PC7). When the 68HC11/68L11 is configured as above, data appearing on the MOSI output is valid on the falling edge of SCK. Serial data from the 68HC11/68L11 is transmitted in 8-bit bytes with only eight falling clock edges occurring in the transmit cycle. Data is transmitted MSB first. To load data to the AD5304/AD5314/AD5324, PC7 is left low after the first eight bits are transferred, a second serial write operation is performed to the DAC, and PC7 is taken high at the end of this procedure.



Figure 37. AD5304/AD5314/AD5324 to 68HC11/68L11 Interface

**AD5304/AD5314/AD5324 to 80C51/80L51 Interface**

Figure 38 shows a serial interface between the AD5304/AD5314/AD5324 and the 80C51/80L51 microcontroller. The setup for the interface is as follows: TxD of the 80C51/80L51 drives SCLK of the AD5304/AD5314/AD5324, while RxD drives the serial data line of the part. The SYNC signal is again derived from a bit-programmable pin on the port. In this case, port line P3.3 is used. When data is to be transmitted to the AD5304/AD5314/AD5324, P3.3 is taken low. The 80C51/80L51 transmits data

only in 8-bit bytes; thus only eight falling clock edges occur in the transmit cycle. To load data to the DAC, P3.3 is left low after the first eight bits are transmitted, and a second write cycle is initiated to transmit the second byte of data. P3.3 is taken high following the completion of this cycle. The 80C51/80L51 outputs the serial data in a format that has the LSB first. The AD5304/AD5314/AD5324 requires its data with the MSB as the first bit received. The 80C51/80L51 transmit routine takes this into account.



Figure 38. AD5304/AD5314/AD5324 to 80C51/80L51 Interface

**AD5304/AD5314/AD5324 to MICROWIRE Interface**

Figure 39 shows an interface between the AD5304/AD5314/AD5324 and any MICROWIRE-compatible device. Serial data is shifted out on the falling edge of the serial clock, SK, and is clocked into the AD5304/AD5314/AD5324 on the rising edge of SK, which corresponds to the falling edge of the DAC's SCLK.



Figure 39. AD5304/AD5314/AD5324 to MICROWIRE Interface



**Opto-Isolated Interface for Process Control Applications**

The AD5304/AD5314/AD5324 have a versatile 3-wire serial interface, making them ideal for generating accurate voltages in process control and industrial applications. Due to noise, safety requirements, or distance, it might be necessary to isolate the AD5304/AD5314/AD5324 from the controller. This can easily be achieved by using opto-isolators, which provide isolation in excess of 3 kV. The actual data rate achieved is limited by the type of optocouplers chosen. The serial loading structure of the AD5304/AD5314/AD5324 makes them ideally suited for use in opto-isolated applications. Figure 42 shows an opto-isolated interface to the AD5304 where DIN, SCLK, and SYNC are driven from optocouplers. The power supply to the part also needs to be isolated. This is done by using a transformer. On the DAC side of the transformer, a 5 V regulator provides the 5 V supply required for the AD5304.



Figure 42. AD5304 in an Opto-Isolated Interface

**DECODING MULTIPLE AD5304/AD5314/AD5324S**

The SYNC pin on the AD5304/AD5314/AD5324 can be used in applications to decode a number of DACs. In this application, all the DACs in the system receive the same serial clock and serial data, but SYNC can only be active to one of the devices at any one time, allowing access to four channels in this 16-channel system. The 74HC139 is used as a 2-to-4-line decoder to address any of the DACs in the system. To prevent timing errors, the enable input must be brought to its inactive state while the coded address inputs are changing state. Figure 43 shows a diagram of a typical setup for decoding multiple AD5304 devices in a system.

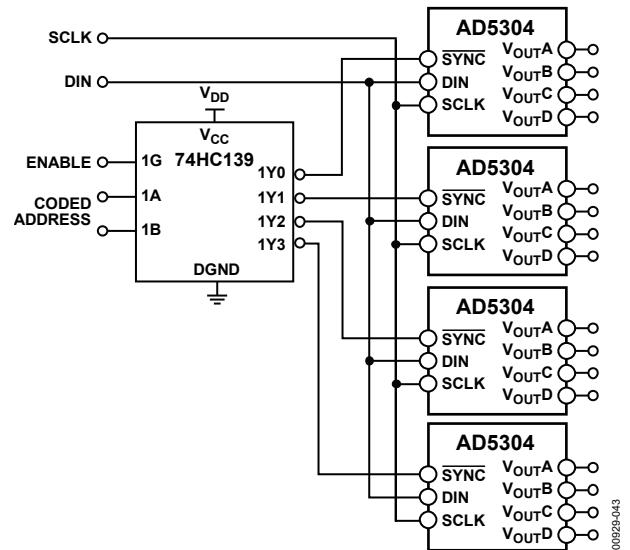
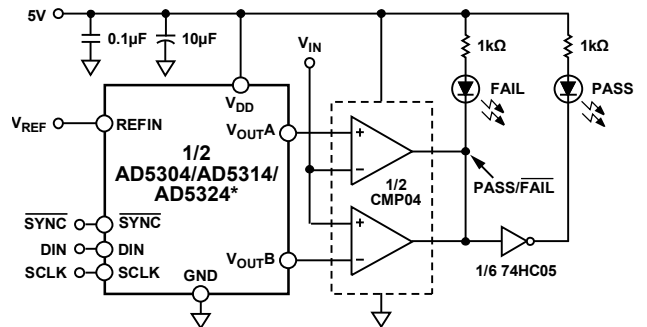

Figure 43. Decoding Multiple AD5304 Devices in a System

**AD5304/AD5314/AD5324 as a Digitally Programmable Window Detector**

A digitally programmable upper/lower limit detector using two DACs in the AD5304/AD5314/AD5324 is shown in Figure 44. The upper and lower limits for the test are loaded to DAC A and DAC B, which, in turn, set the limits on the CMP04. If the signal at the VIN input is not within the programmed window, an LED indicates the fail condition. Similarly, DAC C and DAC D can be used for window detection on a second VIN signal.



\*ADDITIONAL PINS OMITTED FOR CLARITY.

Figure 44. Window Detection

**POWER SUPPLY BYPASSING AND GROUNDING**

In any circuit where accuracy is important, careful consideration of the power supply and ground return layout helps to ensure the rated performance. The printed circuit board on which the AD5304/AD5314/AD5324 is mounted is designed so that the analog and digital sections are separated and confined to certain areas of the board. If the AD5304/AD5314/AD5324 are in a system where multiple devices require an AGND-to-DGND connection, the connection is made at one point only. The star ground point is established as close as possible to the device. The AD5304/AD5314/AD5324 has ample supply bypassing of 10  $\mu\text{F}$  in parallel with 0.1  $\mu\text{F}$  on the supply located as close to the package as possible, ideally right up against the device. The 10  $\mu\text{F}$  capacitors are the tantalum bead type. The 0.1  $\mu\text{F}$  capacitor has low effective series resistance (ESR) and effective series inductance (ESI), like

the common ceramic types that provide a low impedance path to ground at high frequencies, to handle transient currents due to internal logic switching.

The power supply lines of the AD5304/AD5314/AD5324 use as large a trace as possible to provide low impedance paths and reduce the effects of glitches on the power supply line. Fast switching signals such as clocks are shielded with digital ground to avoid radiating noise to other parts of the board, and are never run near the reference inputs. Avoid crossover of digital and analog signals. Traces on opposite sides of the board run at right angles to each other. This reduces the effects of feedthrough through the board. A microstrip technique is by far the best, but is not always possible with a double-sided board. In this technique, the component side of the board is dedicated to a ground plane while signal traces are placed on the solder side.

**Table 7. Overview of AD53xx Serial Devices**

Part No.	Resolution	No. of DACs	DNL	Interface	Settling Time ( $\mu\text{s}$ )	Package	Pins
<b>SINGLES</b>							
AD5300	8	1	$\pm 0.25$	SPI	4	SOT-23, MSOP	6, 8
AD5310	10	1	$\pm 0.5$	SPI	6	SOT-23, MSOP	6, 8
AD5320	12	1	$\pm 1.0$	SPI	8	SOT-23, MSOP	6, 8
AD5301	8	1	$\pm 0.25$	2-Wire	6	SOT-23, MSOP	6, 8
AD5311	10	1	$\pm 0.5$	2-Wire	7	SOT-23, MSOP	6, 8
AD5321	12	1	$\pm 1.0$	2-Wire	8	SOT-23, MSOP	6, 8
<b>DUALS</b>							
AD5302	8	2	$\pm 0.25$	SPI	6	MSOP	8
AD5312	10	2	$\pm 0.5$	SPI	7	MSOP	8
AD5322	12	2	$\pm 1.0$	SPI	8	MSOP	8
AD5303	8	2	$\pm 0.25$	SPI	6	TSSOP	16
AD5313	10	2	$\pm 0.5$	SPI	7	TSSOP	16
AD5323	12	2	$\pm 1.0$	SPI	8	TSSOP	16
<b>QUADS</b>							
AD5304	8	4	$\pm 0.25$	SPI	6	MSOP, LFCSP	10
AD5314	10	4	$\pm 0.5$	SPI	7	MSOP, LFCSP	10
AD5324	12	4	$\pm 1.0$	SPI	8	MSOP, LFCSP	10
AD5305	8	4	$\pm 0.25$	2-Wire	6	MSOP	10
AD5315	10	4	$\pm 0.5$	2-Wire	7	MSOP	10
AD5325	12	4	$\pm 1.0$	2-Wire	8	MSOP	10
AD5306	8	4	$\pm 0.25$	2-Wire	6	TSSOP	16
AD5316	10	4	$\pm 0.5$	2-Wire	7	TSSOP	16
AD5326	12	4	$\pm 1.0$	2-Wire	8	TSSOP	16
AD5307	8	4	$\pm 0.25$	SPI	6	TSSOP	16
AD5317	10	4	$\pm 0.5$	SPI	7	TSSOP	16
AD5327	12	4	$\pm 1.0$	SPI	8	TSSOP	16
<b>OCTALS</b>							
AD5308	8	8	$\pm 0.25$	SPI	6	TSSOP	16
AD5318	10	8	$\pm 0.5$	SPI	7	TSSOP	16
AD5328	12	8	$\pm 1.0$	SPI	8	TSSOP	16

Table 8. Overview of AD53xx Parallel Devices

Part No.	Resolution	DNL	V <sub>REF</sub> Pins	Settling Time (μs)	Additional Pin Functions				Package	Pins
					BUF	GAIN	HBEN	CLR		
<b>SINGLES</b>										
AD5330	8	±0.25	1	6	✓	✓		✓	TSSOP	20
AD5331	10	±0.5	1	7		✓		✓	TSSOP	20
AD5340	12	±1.0	1	8	✓	✓		✓	TSSOP	24
AD5341	12	±1.0	1	8	✓	✓	✓	✓	TSSOP	20
<b>DUALS</b>										
AD5332	8	±0.25	2	6				✓	TSSOP	20
AD5333	10	±0.5	2	7	✓	✓		✓	TSSOP	24
AD5342	12	±1.0	2	8	✓	✓		✓	TSSOP	28
AD5343	12	±1.0	1	8			✓	✓	TSSOP	20
<b>QUADS</b>										
AD5334	8	±0.25	2	6		✓		✓	TSSOP	24
AD5335	10	±0.5	2	7			✓	✓	TSSOP	24
AD5336	10	±0.5	4	7		✓		✓	TSSOP	28
AD5344	12	±1.0	4	8					TSSOP	28

OUTLINE DIMENSIONS

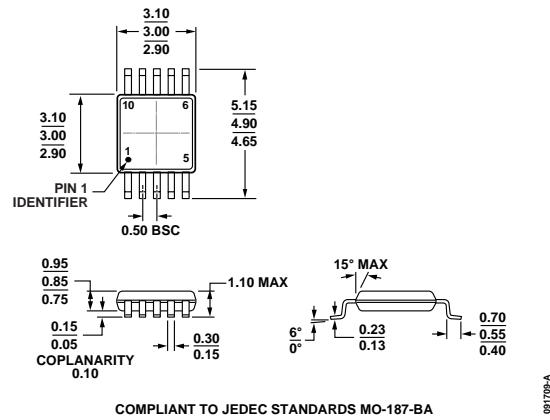

COMPLIANT TO JEDEC STANDARDS MO-187-BA  
 Figure 45. 10-Lead Mini Small Outline Package [MSOP]  
 (RM-10)  
 Dimensions shown in millimeters

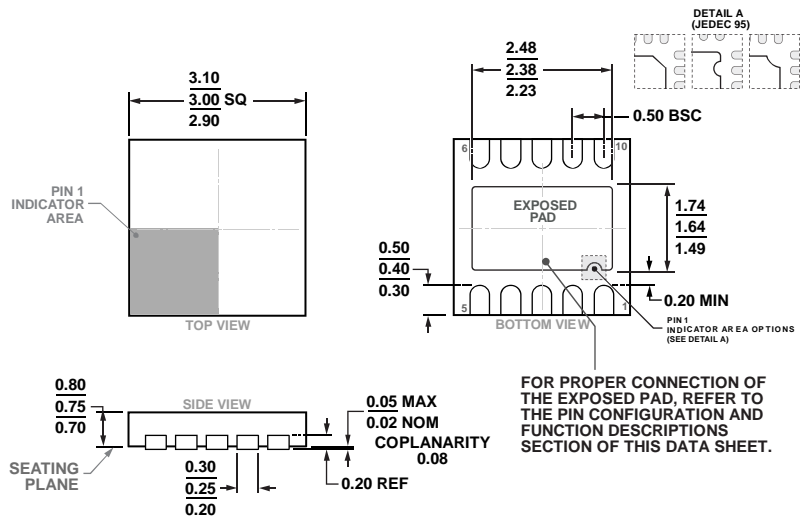

Figure 46. 10-Lead Lead Frame Chip Scale Package [LFCSP]  
 3 mm x 3 mm Body and 0.75 mm Package Height  
 (CP-10-9)  
 Dimensions shown in millimeters

**ORDERING GUIDE**

Model <sup>1, 2</sup>	Temperature Range	Package Description	Package Option	Marking Code
AD5304ARMZ	-40°C to +105°C	10-Lead MSOP	RM-10	D9W
AD5304ARMZ-REEL7	-40°C to +105°C	10-Lead MSOP	RM-10	D9W
AD5304ACPZ-REEL7	-40°C to +105°C	10-Lead LFCSP	CP-10-9	DBA#
AD5304BRMZ	-40°C to +105°C	10-Lead MSOP	RM-10	DBB#
AD5304BRMZ-REEL	-40°C to +105°C	10-Lead MSOP	RM-10	DBB#
AD5304BRMZ-REEL7	-40°C to +105°C	10-Lead MSOP	RM-10	DBB#
AD5314ACPZ-REEL7	-40°C to +105°C	10-Lead LFCSP	CP-10-9	DCA#
AD5314ARMZ	-40°C to +105°C	10-Lead MSOP	RM-10	DCA#
AD5314ARMZ-REEL7	-40°C to +105°C	10-Lead MSOP	RM-10	DCA#
AD5314WARMZ-REEL7	-40°C to +105°C	10-Lead MSOP	RM-10	DCA#
AD5314BCPZ-REEL7	-40°C to +105°C	10-Lead LFCSP	CP-10-9	DCB#
AD5314BRMZ	-40°C to +105°C	10-Lead MSOP	RM-10	DCB#
AD5314BRMZ-REEL	-40°C to +105°C	10-Lead MSOP	RM-10	DCB#
AD5314BRMZ-REEL7	-40°C to +105°C	10-Lead MSOP	RM-10	DCB#
AD5324ACPZ-REEL7	-40°C to +105°C	10-Lead LFCSP	CP-10-9	DDA#
AD5324ARMZ	-40°C to +105°C	10-Lead MSOP	RM-10	D8F
AD5324ARMZ-REEL7	-40°C to +105°C	10-Lead MSOP	RM-10	D8F
AD5324BCPZ-REEL7	-40°C to +105°C	10-Lead LFCSP	CP-10-9	DDB#
AD5324BRMZ	-40°C to +105°C	10-Lead MSOP	RM-10	DDB#
AD5324BRMZ-REEL	-40°C to +105°C	10-Lead MSOP	RM-10	DDB#
EVAL-AD5324DBZ		Evaluation Board		

<sup>1</sup> Z = RoHS Compliant Part; # denotes lead-free product can be top or bottom marked.

<sup>2</sup> W = Qualified for Automotive Applications.

**AUTOMOTIVE PRODUCTS**

The AD5314WARMZ-REEL7 model is available with controlled manufacturing to support the quality and reliability requirements of automotive applications. Note that this automotive model may have specifications that differ from the commercial models; therefore designers should review the Specifications section of this data sheet carefully. Only the automotive grade product shown is available for use in automotive applications. Contact your local Analog Devices account representative for specific product ordering information and to obtain the specific Automotive Reliability reports for this model.

**NOTES**

## Looking for pricing, stock, or lifecycle information?

Click below to explore more details on WIN SOURCE:

- ⊖ [View AD5314ARMZ-REEL7 on WIN SOURCE](#)
- ⊖ [Analog Devices Inc. Information](#)

## Optimize Your Supply Chain with WIN SOURCE Solutions

- ✓ Global Sourcing Solution
- ✓ Obsolete Management
- ✓ Cost Control Management
- ✓ Shortage Management
- ✓ Alternative Solution
- ✓ Excess Inventory Management