



THE DATASHEET OF CURB206-G



CURB201-G Thru. CURB207-G

Reverse Voltage: 50 to 1000 Volts

Forward Current: 2.0 Amp

RoHS Device

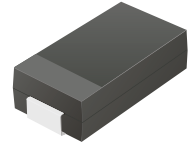

Features

- Glass passivated chip
- Low forward voltage
- High current capability
- High reliability
- Fast surge current capability
- High speed switching

Mechanical data

- Case: JEDEC DO-214AA, molded plastic.
- Epoxy: UL 94V-0 rate flame retardant
- Terminals: Solderable per MIL-STD-750, method 2026.
- Polarity: Color band denotes cathode end.
- Mounting position: Any

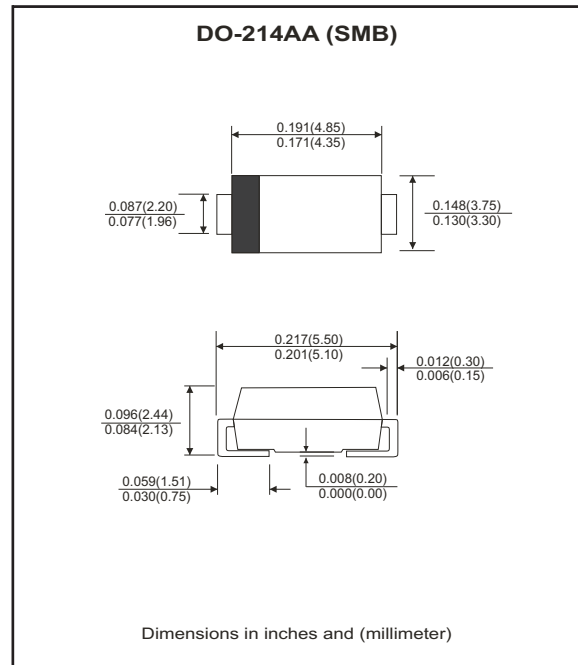

Circuit diagram



Maximum Ratings and Electrical Characteristics

(T_A=25°C unless otherwise noted)

Parameter	Symbol	CURB 201-G	CURB 202-G	CURB 203-G	CURB 204-G	CURB 205-G	CURB 206-G	CURB 207-G	Unit
Max. Repetitive peak reverse voltage	V _{RRM}	50	100	200	400	600	800	1000	V
Max. DC blocking voltage	V _{DC}	50	100	200	400	600	800	1000	V
Max. RMS voltage	V _{RMS}	35	70	140	280	420	560	700	V
Max. Average forward current @ T _A =25°C	I _o	2							A
Max. Instantaneous forward voltage at 2.0A	V _F	1.0				1.7			V
Reverse recovery time	T _{rr}	50				75			nS
Max. DC reverse current @ T _A =25°C	I _R	5							μA
Operating temperature range	T _J	-55 to +150							°C
Storage temperature range	T _{STG}	-55 to +150							°C

Notes:

1. Reverse recovery test conditions: I_F=0.5A, I_R=1.0A, I_{RR}=0.25A (RG1 circuit)

Company reserves the right to improve product design , functions and reliability without notice.

REV:B

RATING AND CHARACTERISTIC CURVES (CURB201-G thru CURB207-G)

Fig.1 - Forward Current Derating Curve

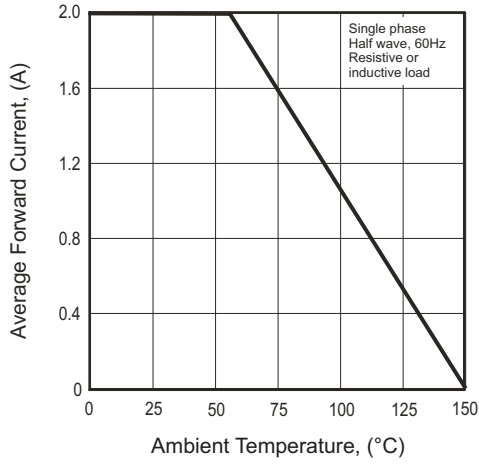

Fig.2 - Maximum Non-Repetitive Surge Current

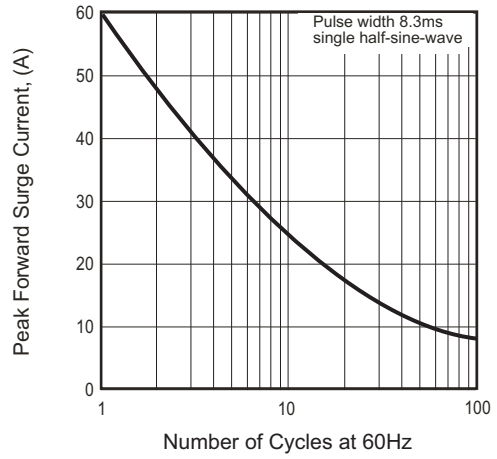

Fig.3 - Typical Forward Characteristics

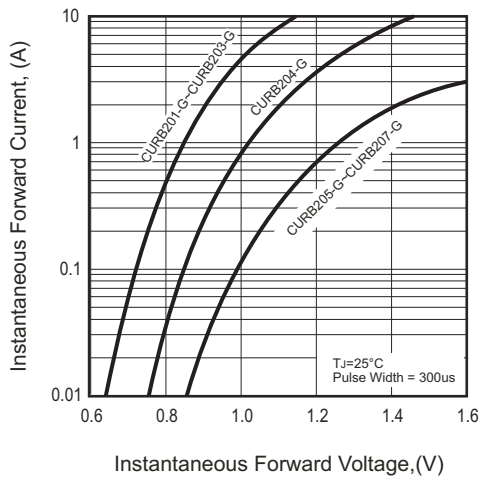
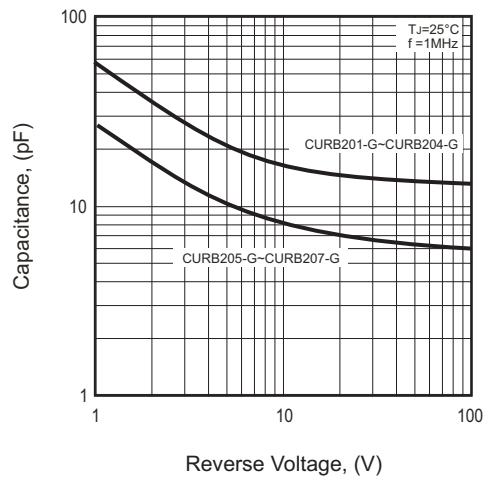
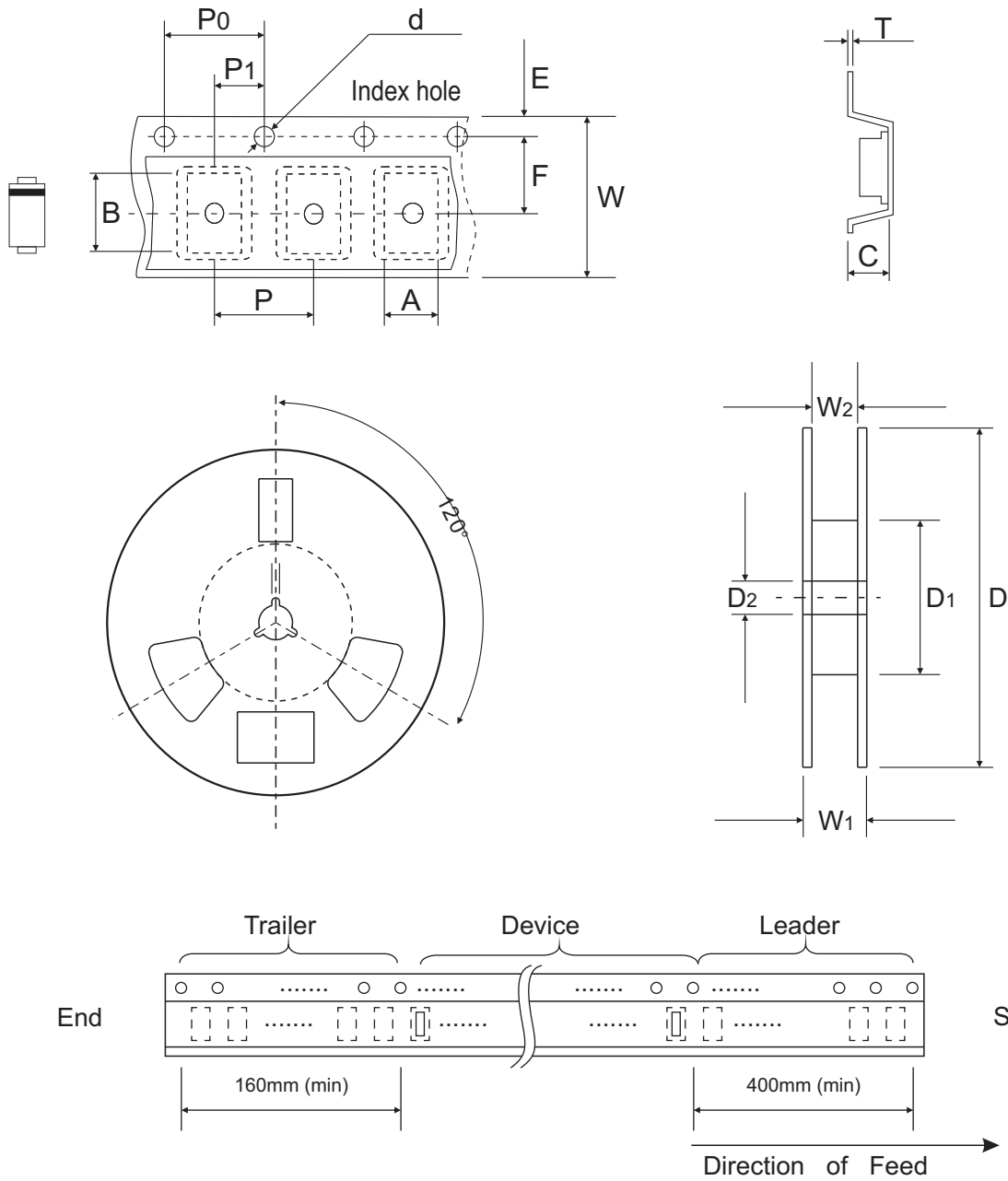

Fig.4 - Typical Junction Capacitance



Reel Taping Specification



DO-214AA (SMB)	SYMBOL	A	B	C	d	D	D1	D2	E
	(mm)	See Note 1			1.55 ± 0.05	330.00	50.00 (Min.)	13.00 + 0.50 - 0.20	1.75 ± 0.10
	(inch)	See Note 1			0.061 ± 0.002	12.992	1.969 (Min.)	0.512 + 0.020 - 0.008	0.069 ± 0.004

DO-214AA (SMB)	SYMBOL	F	P	P0	P1	T	W	W1	W2
	(mm)	5.50 ± 0.05	8.00 ± 0.10	4.00 ± 0.10	2.00 ± 0.05	0.40 (Max.)	12.00 ± 0.10	18.40 (Max.)	12.40 + 2.00 - 0.00
	(inch)	0.217 ± 0.002	0.315 ± 0.004	0.157 ± 0.004	0.079 ± 0.002	0.016 (Max.)	0.472 ± 0.004	0.724 (Max.)	0.488 + 0.079 - 0.000

Notes: 1. A, B, and C the clearance between the component and the cavity must be within 0.5mm max. for 8mm tape and 12mm tape, 1.0mm max. for 16mm tape and 24mm tape.

Marking Code

Part Number	Marking Code
CURB201-G	201
CURB202-G	202
CURB203-G	203
CURB204-G	204
CURB205-G	205
CURB206-G	206
CURB207-G	207

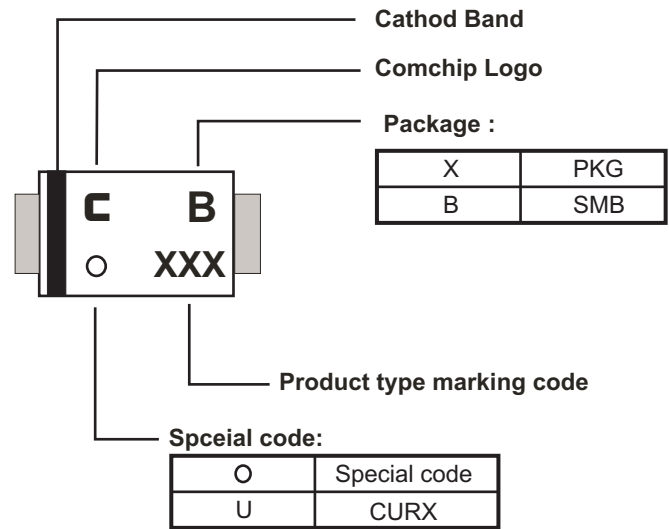

Suggested PAD Layout

SIZE	DO-214AA(SMB)	
	(mm)	(inch)
A	5.60 REF	0.220 REF
B	2.16 MAX	0.085 MAX
C	1.52 MIN	0.060 MIN
D	2.18 MIN	0.086 MIN

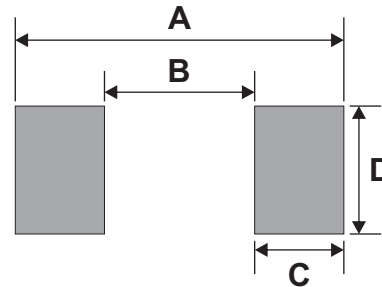

Standard Packaging

Case Type	REEL PACK	
	REEL (pcs)	Reel Size (inch)
DO-214AA (SMB)	3,000	13

Looking for pricing, stock, or lifecycle information?

Click below to explore more details on WIN SOURCE:

- [View CURB206-G on WIN SOURCE](#)
- [Comchip Technology Information](#)

Optimize Your Supply Chain with WIN SOURCE Solutions

- ✓ Global Sourcing Solution
- ✓ Obsolete Management
- ✓ Cost Control Management
- ✓ Shortage Management
- ✓ Alternative Solution
- ✓ Excess Inventory Management