



THE DATASHEET OF CSFB203-G



CSFB201-G Thru. CSFB205-G

Reverse Voltage: 50 to 600 Volts

Forward Current: 2.0 Amp

RoHS Device

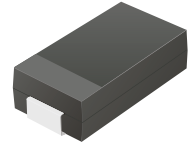

Features

- Ideal for surface mount applications.
- Easy pick and place.
- Plastic package has Underwriters Lab. flammability classification 94V-0.
- Super fast recovery time 35nS.
- Built-in strain relief.
- Low forward voltage drop.

Mechanical data

- Case: JEDEC DO-214AA, molded plastic.
- Terminals: solderable per MIL-STD-750, method 2026.
- Polarity: Color band denotes cathode end.
- Approx. weight: 0.093 grams

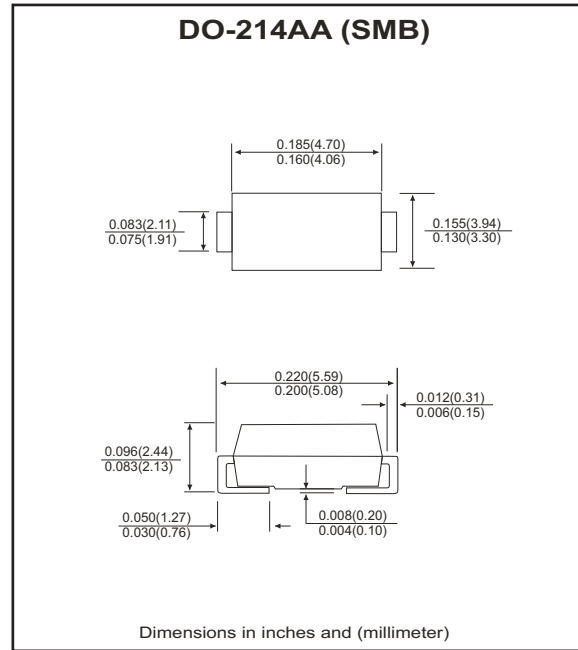

Maximum Ratings and Electrical Characteristics

Parameter	Symbol	CSFB201-G	CSFB202-G	CSFB203-G	CSFB204-G	CSFB205-G	Units
Max. repetitive peak reverse voltage	V_{RRM}	50	100	200	400	600	V
Max. DC blocking voltage	V_{DC}	50	100	200	400	600	V
Max. RMS voltage	V_{RMS}	35	70	140	280	420	V
Peak surge forward current, 8.3ms single half sine-wave superimposed on rate load (JEDEC method)	I_{FSM}	50					A
Max. average forward current	I_o	2.0					A
Max. instantaneous forward voltage at 2.0A	V_F	0.95			1.25	1.70	V
Reverse recovery time	T_{rr}	35					nS
Max. DC reverse current at $T_A=25^\circ\text{C}$ rated DC blocking voltage $T_A=125^\circ\text{C}$	I_R				5.0	350	μA
Max. thermal resistance (Note 1)	$R_{\theta JL}$	20					$^\circ\text{C/W}$
Max. operating junction temperature	T_J	150					$^\circ\text{C}$
Storage temperature	T_{STG}	-55 to +150					$^\circ\text{C}$

Notes: 1. Thermal resistance from junction to lead mounted on P.C.B. with 8.0×8.0 mm copper pad area.

RATING AND CHARACTERISTIC CURVES (CSFB201-G thru CSFB205-G)

Fig.1- Reverse characteristics

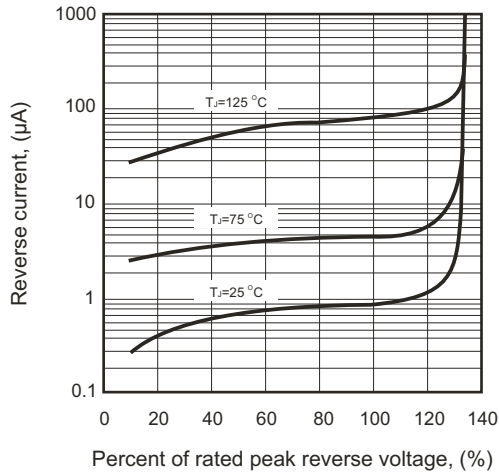

Fig.2- Forward characteristics

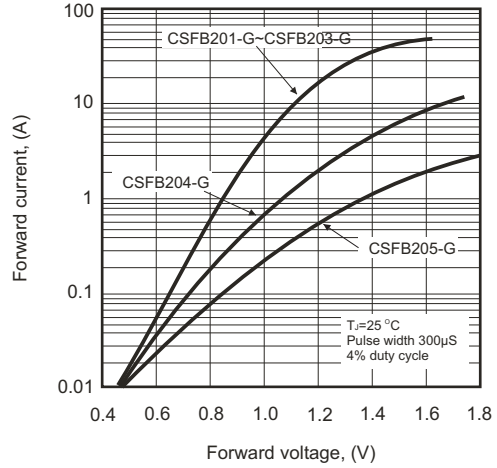

Fig.3- Junction capacitance

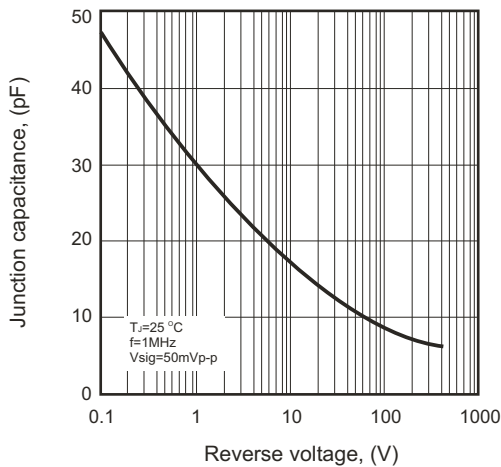

Fig.4- Non-repetitive forward surge current

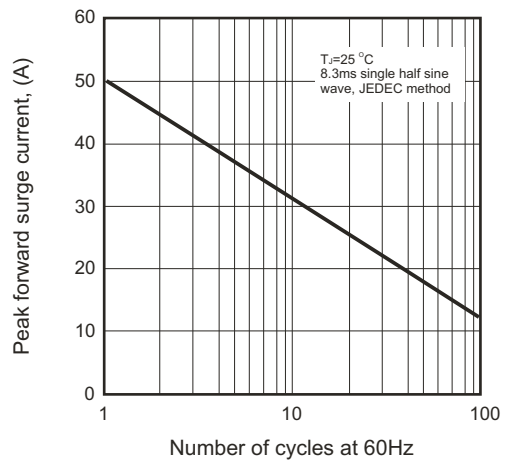

Fig.5- Test circuit diagram and reverse recovery time characteristics

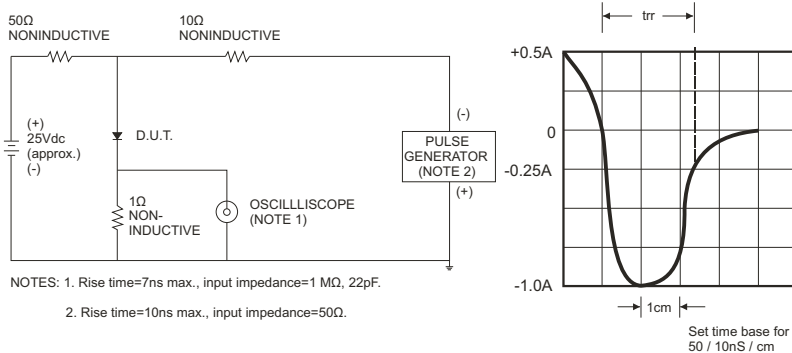
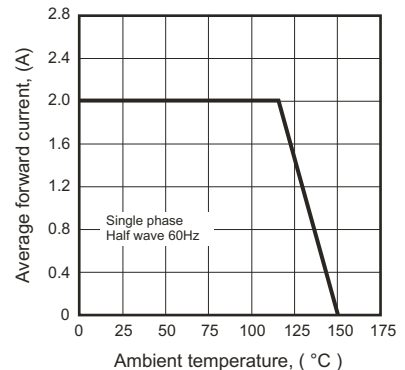
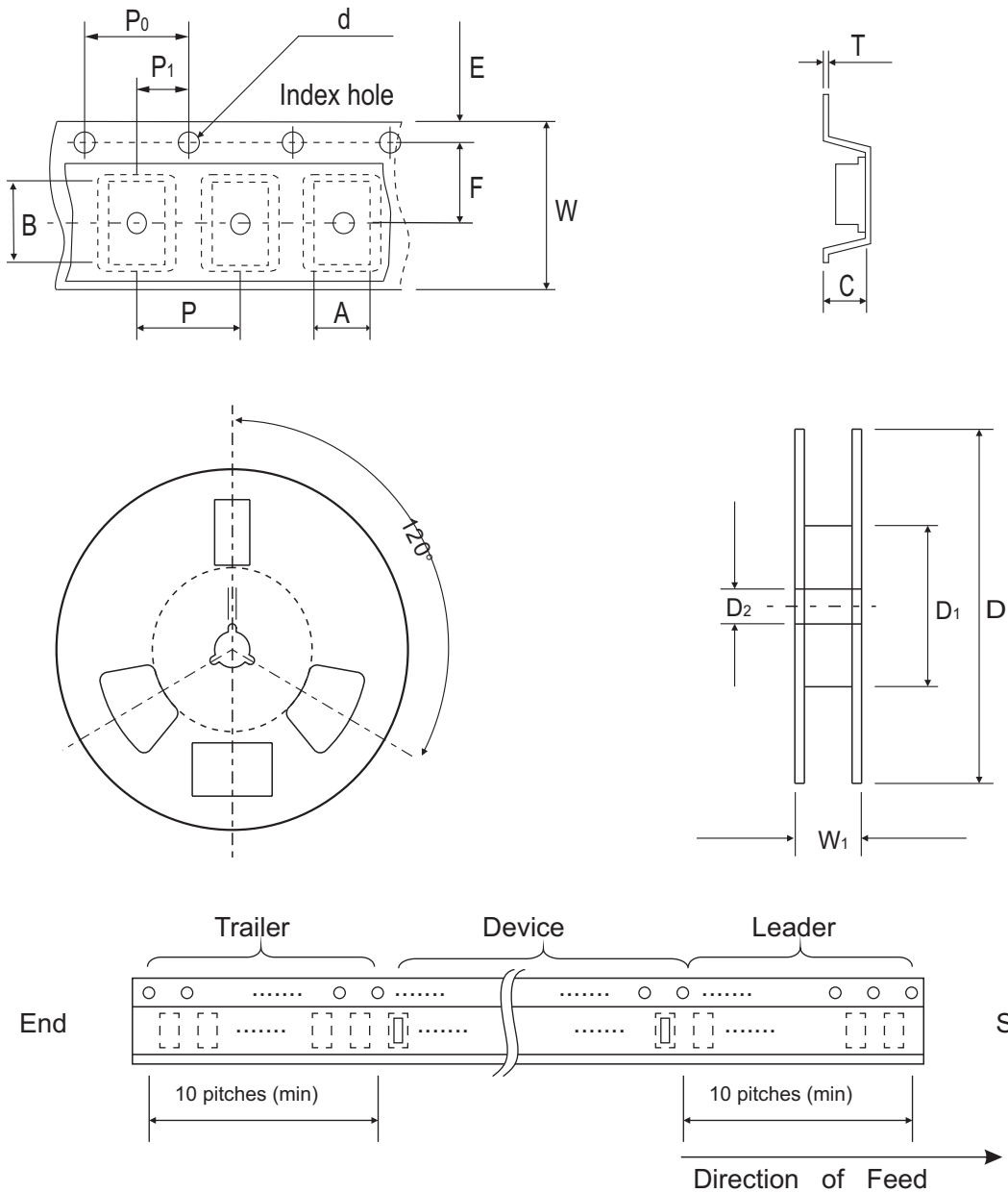

Fig.6- Current derating curve



Reel Taping Specification



DO-214AA(SMB)	SYMBOL	A	B	C	d	D	D1	D2
	(mm)	4.00 MAX.	5.90 MAX.	3.00 MAX.	1.50 ± 0.10 _{DIA}	330 ± 2.00	50.0 MIN.	13.50 ± 1.0
	(inch)	0.157 MAX.	0.232 MAX.	0.118 MAX.	0.059 ± 0.004 _{DIA}	12.99 ± 0.079	1.969 MIN.	0.531 ± 0.039

DO-214AA(SMB)	SYMBOL	E	F	P	P0	P1	T	W	W1
	(mm)	1.75 ± 0.10	5.50 ± 0.05	8.00 ± 0.10	4.00 ± 0.10	2.00 ± 0.05	0.60 MAX	12.0 ± 0.30	18.4 MAX.
	(inch)	0.0699 ± 0.004	0.217 ± 0.002	0.315 ± 0.004	0.157 ± 0.004	0.079 ± 0.004	0.236 ± 0.004	0.472 ± 0.012	0.724 MAX.

Marking Code

Part Number	Marking Code
CSFB201-G	201
CSFB202-G	202
CSFB203-G	203
CSFB204-G	204
CSFB205-G	205

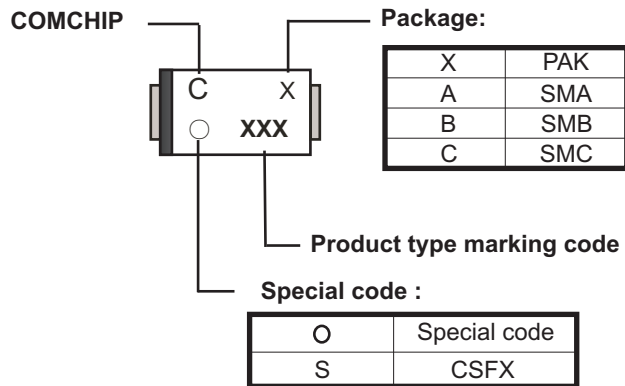

Suggested PAD Layout

SIZE	SMB	
	(mm)	(inch)
A	4.30	0.169
B	2.50	0.098
C	2.30	0.091
D	6.80	0.268
E	1.80	0.071

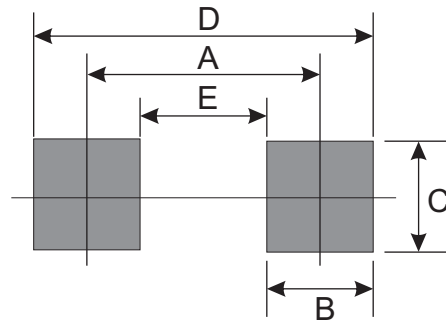

Standard Packaging

Case Type	Qty Per Reel	Reel Size
	(Pcs)	(inch)
DO-214AA(SMB)	3,000	13

Looking for pricing, stock, or lifecycle information?

Click below to explore more details on WIN SOURCE:

- [View CSFB203-G on WIN SOURCE](#)
- [Comchip Technology Information](#)

Optimize Your Supply Chain with WIN SOURCE Solutions

- ✓ Global Sourcing Solution
- ✓ Obsolete Management
- ✓ Cost Control Management
- ✓ Shortage Management
- ✓ Alternative Solution
- ✓ Excess Inventory Management