



# THE DATASHEET OF CFRA106-G



## CFRA101-G Thru. CFRA107-G

Reverse Voltage: 50 to 1000 Volts

Forward Current: 1.0 Amp

RoHS Device

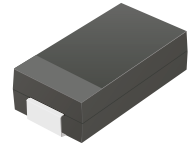

### Features

- Glass passivated chip.
- Low forward voltage
- High current capability
- High reliability
- High surge current capability.

### Mechanical data

- Epoxy: UL 94V-0 rate flame retardant.
- Case: SMA/DO-214AC, molded plastic.
- Terminals: Solderable per MIL-STD-750, method 2026.
- Polarity: Color band denotes cathode end.
- Weight: 0.069 grams(approx.)

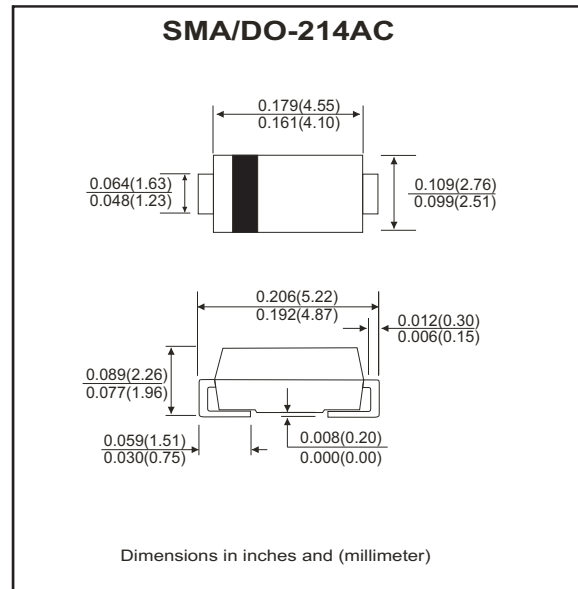

### Circuit diagram



### Maximum Rating And Electrical Characteristics (at TA=25°C unless otherwise noted)

Parameter	Symbol	CFRA 101-G	CFRA 102-G	CFRA 103-G	CFRA 104-G	CFRA 105-G	CFRA 106-G	CFRA 107-G	Unit
Max. repetitive peak reverse voltage @ I <sub>T</sub> =5μA	V <sub>RRM</sub>	50	100	200	400	600	800	1000	V
Max. DC blocking voltage	V <sub>DC</sub>	50	100	200	400	600	800	1000	V
Max. RMS voltage	V <sub>RMS</sub>	35	70	140	280	420	560	700	V
Max. average forward rectified current	I <sub>O</sub>	1.0							A
Max. Instantaneous forward voltage at specified current	V <sub>F</sub>	1.3							V
Max. Reverse recovery time (Note 1)	T <sub>rr</sub>	150				250	500		nS
Max. DC reverse current at T <sub>A</sub> =25°C	I <sub>R</sub>	5.0							μA
Operating temperature range	T <sub>J</sub>	-55 to +150							°C
Storage temperature range	T <sub>STG</sub>	-55 to +150							°C

Notes: 1. Reverse recovery test conditions: I<sub>F</sub>=0.5A, I<sub>R</sub>=1.0A, I<sub>RR</sub>=0.25A(RGI circuit)

## RATING AND CHARACTERISTIC CURVES (CFRA101-G thru CFRA107-G)

Fig.1 - Typical Forward Current Derating Curve

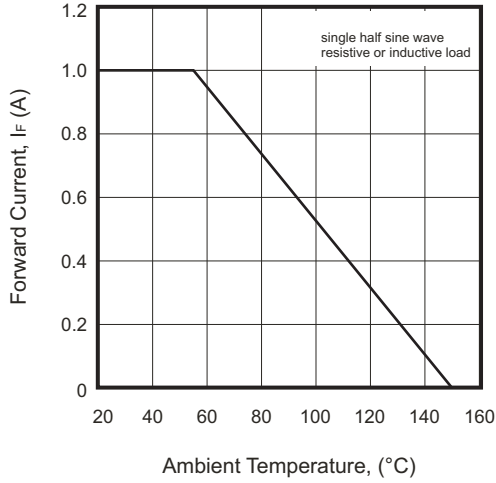

Fig. 2 - Maximum Non-Repetitive Forward Surge Current

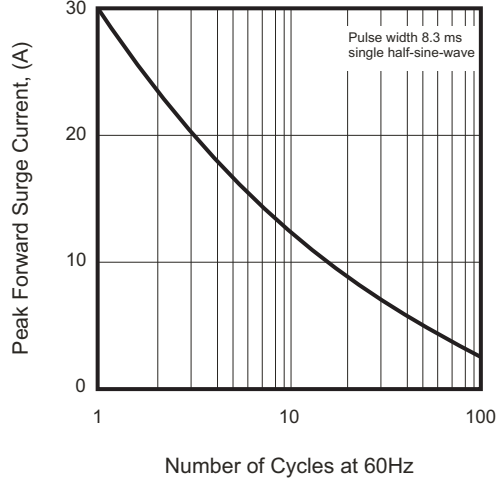

Fig.3 - Typical Forward Characteristics

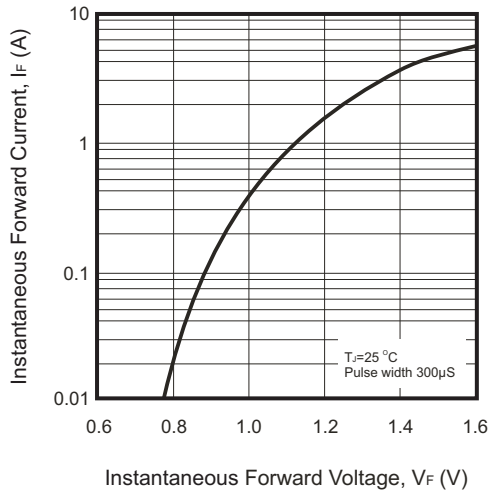
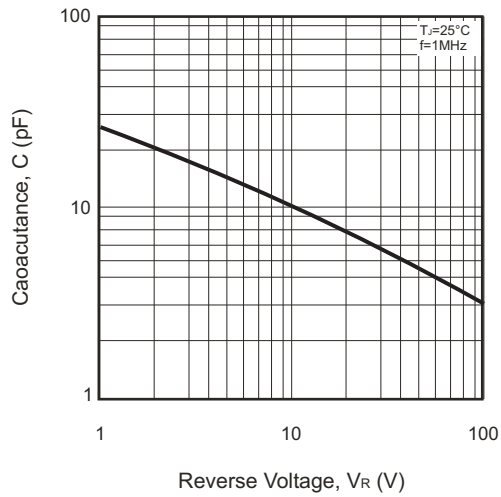
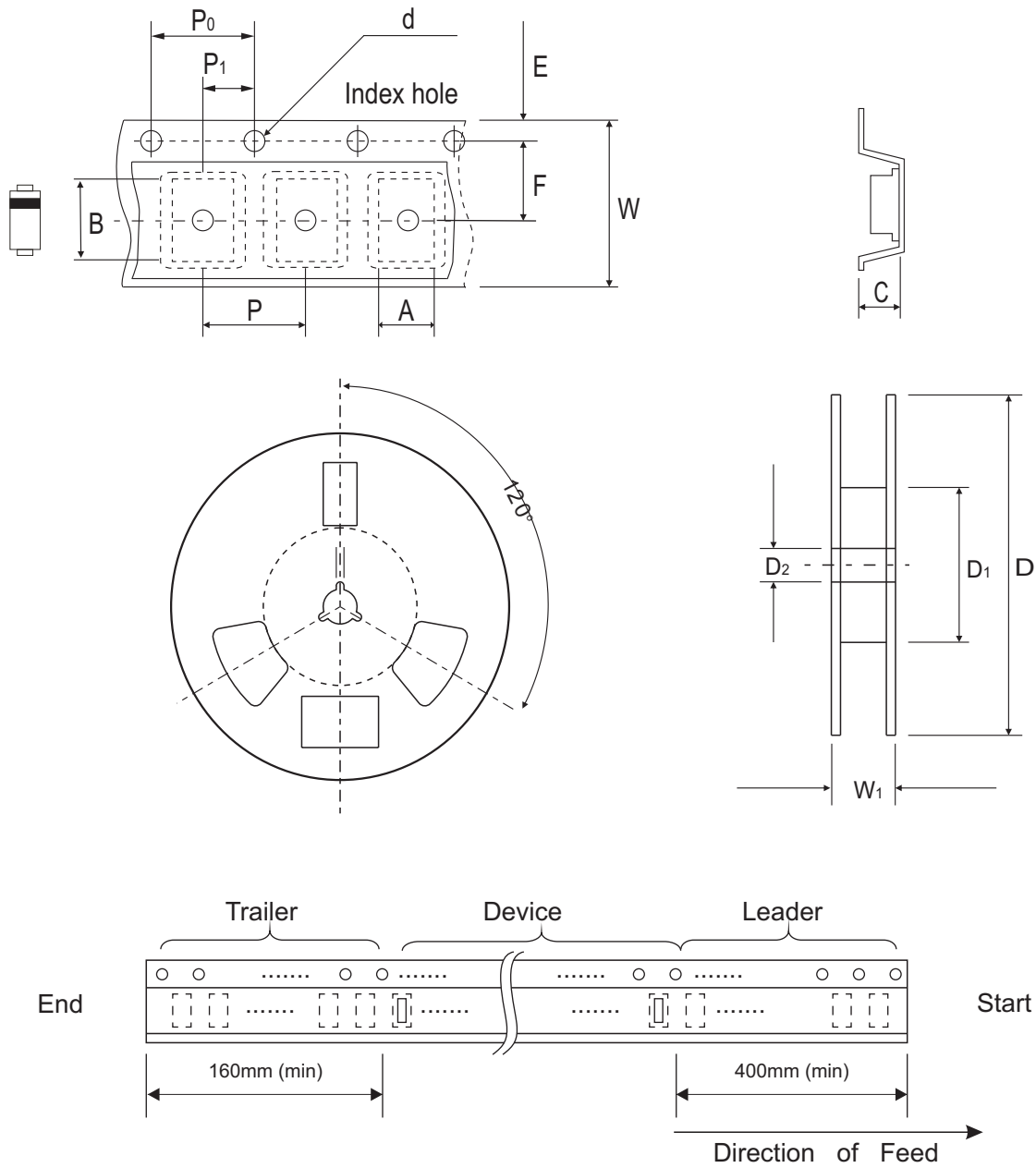

Fig.4 - Typical Junction Capacitance



## Reel Taping Specification



	SYMBOL	A	B	C	d	D	D1	D2
SMA/DO-214AC	(mm)	2.79 ± 0.10	5.33 ± 0.10	2.36 ± 0.10	1.55 ± 0.05	330.00 ± 1.00	50.00 MIN.	13.00 + 0.50 - 0.20
	(inch)	0.110 ± 0.004	0.210 ± 0.004	0.093 ± 0.004	0.061 ± 0.002	12.99 ± 0.039	1.969 MIN.	0.512 + 0.020 - 0.008

	SYMBOL	E	F	P	P0	P1	W	W1
SMA/DO-214AC	(mm)	1.75 ± 0.10	5.50 ± 0.05	4.00 ± 0.10	4.00 ± 0.10	2.00 ± 0.05	12.00 ± 0.10	18.40 MAX.
	(inch)	0.069 ± 0.004	0.217 ± 0.002	0.157 ± 0.004	0.157 ± 0.004	0.079 ± 0.002	0.472 ± 0.004	0.724 MAX

## Marking Code

Part Number	Marking Code
CFRA101-G	101
CFRA102-G	102
CFRA103-G	103
CFRA104-G	104
CFRA105-G	105
CFRA106-G	106
CFRA107-G	107

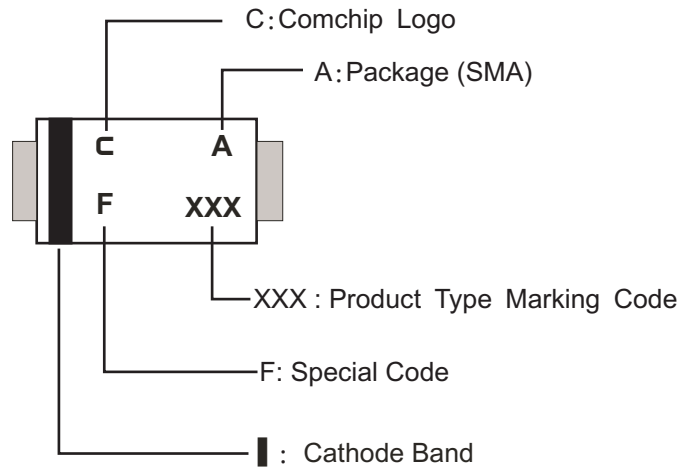

## Suggested PAD Layout

SIZE	DO-214AC(SMA)	
	(mm)	(inch)
A	5.28	0.208
B	1.88 MAX	0.074 MAX
C	1.52 MIN	0.060 MIN
D	1.68 MIN	0.066 MIN

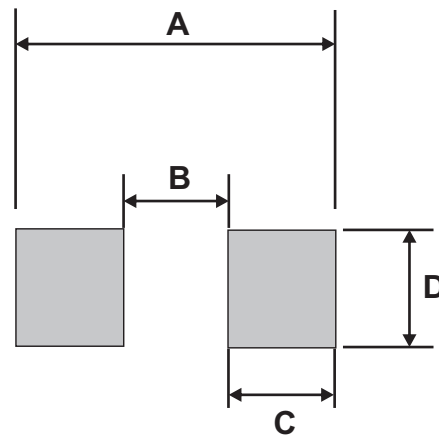

## Standard Packaging

Case Type	REEL PACK	
	REEL ( pcs )	Reel Size (inch)
SMA/DO-214AC	5,000	13

## Looking for pricing, stock, or lifecycle information?

Click below to explore more details on WIN SOURCE:

- [View CFRA106-G on WIN SOURCE](#)
- [Comchip Technology Information](#)

## Optimize Your Supply Chain with WIN SOURCE Solutions

- ✓ Global Sourcing Solution
- ✓ Obsolete Management
- ✓ Cost Control Management
- ✓ Shortage Management
- ✓ Alternative Solution
- ✓ Excess Inventory Management