

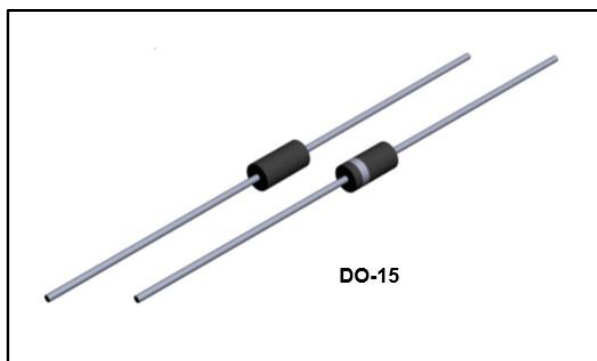

**THE DATASHEET OF
BZW06-33**





Description

Transil diodes provide high overvoltage protection by clamping action.

Their instantaneous response to transient overvoltages makes them particularly suited to protect voltage sensitive devices such as MOS technology and low voltage supplied IC's.

Table 1: Order codes

Part number	Marking
BZW06-xxxx	See Table 4 .

Features

- 600 W peak pulse power (10/1000 μ s)
- Stand-off voltage range 5.8 to 376 V
- Unidirectional and bidirectional types
- Low clamping factor
- Fast response time
- UL recognized, file: E136224

1 Characteristics

Table 2: Absolute maximum ratings ($T_{amb} = 25\text{ }^{\circ}\text{C}$)

Symbol	Parameter		Value	Unit
P_{pp}	Peak pulse power	$T_j \text{ initial} = T_{amb}$	600	W
P	Power dissipation on infinite heatsink	$T_{amb} = 75\text{ }^{\circ}\text{C}$	1.7	
I_{FSM}	Non repetitive surge peak forward current	$t_p = 10\text{ ms}$ $T_j \text{ initial} = T_{amb}$	100	A
T_{stg}	Storage junction temperature range		-65 to +175	$^{\circ}\text{C}$
T_j	Operating junction temperature range		-55 to +175	
T_L	Maximum temperature for soldering during 10 s at 5 mm from case		260	

Figure 1: Electrical characteristics (definitions)

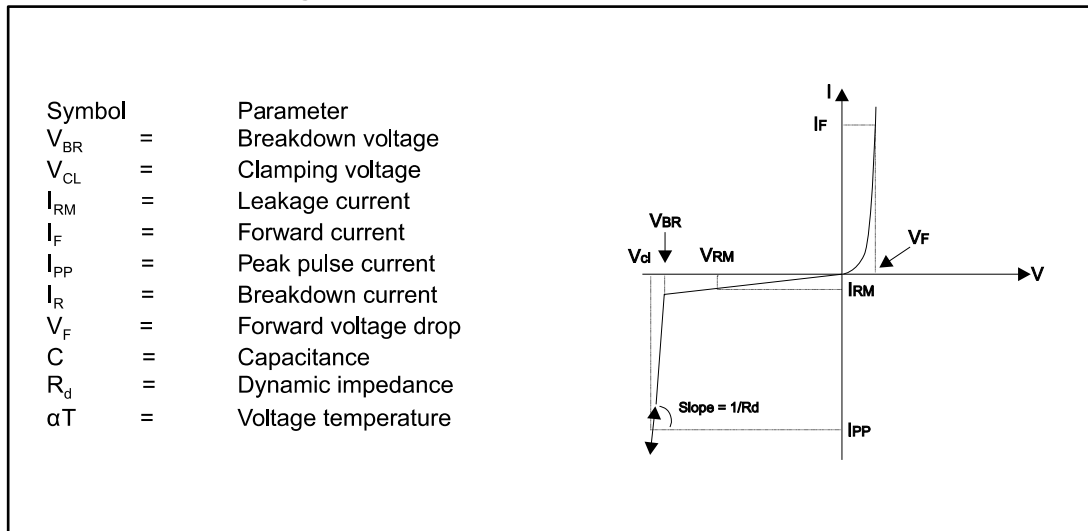

Table 3: Thermal resistances

Symbol	Parameter	Value	Unit
$R_{th(j-l)}$	Junction to leads	60	$^{\circ}\text{C/W}$
$R_{th(j-a)}$	Junction to ambient on printed circuit. $L_{lead} = 10\text{ mm}$	100	

Table 4: Electrical characteristics (T_{amb} = 25 °C)

Types (marking)		I _{RM} at V _{RM} ⁽¹⁾		V _{BR} at I _R ⁽²⁾		V _{CL} at I _{PP}		V _{CL} at I _{PP}		αT ⁽³⁾	C ⁽⁴⁾
		Max.		Min.		Max.		Max.		Max.	Typ.
Unidirectional	Bidirectional	μA	V	V	mA	10/1000 μs		8/20 μs		10 ⁻⁴ /°C	pF
BZW06-5V8	BZW06-5V8B	20	5.8	6.45	10	10.5	57.0	13.4	298	5.7	4000
BZW06-6V4	BZW06-6V4B	10	6.4	7.13	10	11.3	53.0	14.5	276	6.1	3700
BZW06-8V5	BZW06-8V5B	1	8.5	9.5	1	14.5	41	18.6	215	7.3	2800
BZW06-10	BZW06-10B	0.2	10	11.4	1	16.7	36.0	21.7	184	7.8	2300
BZW06-13	BZW06-13B	0.2	13	14.3	1	21.2	28.0	27.2	147	8.4	1900
BZW06-15	BZW06-15B	0.2	15	17.1	1	25.2	24.0	32.5	123	8.8	1600
BZW06-19	BZW06-19B	0.2	19	20.9	1	30.6	19.6	39.3	102	9.2	1350
BZW06-20	BZW06-20B	0.2	20	22.8	1	33.2	18.0	42.8	93	9.4	1250
BZW06-23	BZW06-23B	0.2	23	25.7	1	37.5	16.0	48.3	83	9.6	1150
BZW06-26	BZW06-26B	0.2	26	28.5	1	41.5	14.5	53.5	75	9.7	1075
BZW06-28	BZW06-28B	0.2	28	31.4	1	45.7	13.1	59	68	9.8	1000
BZW06-31	BZW06-31B	0.2	31	34.2	1	49.9	12.0	64.3	62	9.9	950
BZW06-33	BZW06-33B	0.2	33	37.1	1	53.9	11.1	69.7	57	10.0	900
BZW06-37	BZW06-37B	0.2	36.8	40.9	1	59.3	10.1	76	53	10.1	850
BZW06-40	BZW06-40B	0.2	40	44.7	1	64.8	9.3	84	48	10.1	800
BZW06-48	BZW06-48B	0.2	48	53.2	1	77.0	7.8	100	40	10.3	700
BZW06-58	BZW06-58B	0.2	58	64.6	1	92.0	6.5	121	33	10.4	625
BZW06-70	BZW06-70B	0.2	70	77.9	1	113	5.3	146	27.0	10.5	550
BZW06-85	BZW06-85B	0.2	85	95.0	1	137	4.4	178	22.5	10.6	500
BZW06-102	BZW06-102B	0.2	102	114	1	165	3.6	212	19.0	10.7	450
BZW06-128	BZW06-128B	0.2	128	143	1	207	2.9	265	15.0	10.8	400
BZW06-154	BZW06-154B	0.2	154	171	1	246	2.4	317	12.6	10.8	360
BZW06-171	BZW06-171B	0.2	171	190	1	274	2.2	353	11.3	10.8	350
BZW06-188	BZW06-188B	0.2	188	209	1	328	1.85	388	10.3	10.8	330
BZW06-213	BZW06-213B	0.2	213	237	1	344	1.75	442	9.0	11.0	310
BZW06-256	BZW06-256B	0.2	256	285	1	414	1.45	529	7.6	11.0	290
BZW06-273	BZW06-273B	0.2	273	304	1	438	1.40	564	7.1	11.0	280
BZW06-299	BZW06-299B	0.2	299	332	1	482	1.25	618	6.5	11.0	271
BZW06-342	BZW06-342B	0.2	342	380	1	548	1.1	706	5.7	11.0	360
BZW06-376	BZW06-376B	0.2	376	418	1	603	1	776	5.7	11.0	350

Notes:(1) For bidirectional types having V_{RM} ≤ 10 V, I_{RM} is multiplied by 2(2) Pulse test : t_p < 50 ms(3) To calculate V_{BR} or V_{CL} versus junction temperature, use the following formulas:V_{BR} at T_j = V_{BR} at 25 °C x (1 + αT x (T_j - 25)) or V_{CL} at T_j = V_{CL} at 25 °C x (1 + αT x (T_j - 25))(4) V_R = 0 V, F = 1 MHz. For bidirectional types, capacitance value is divided by 2

1.1 Characteristics (curves)

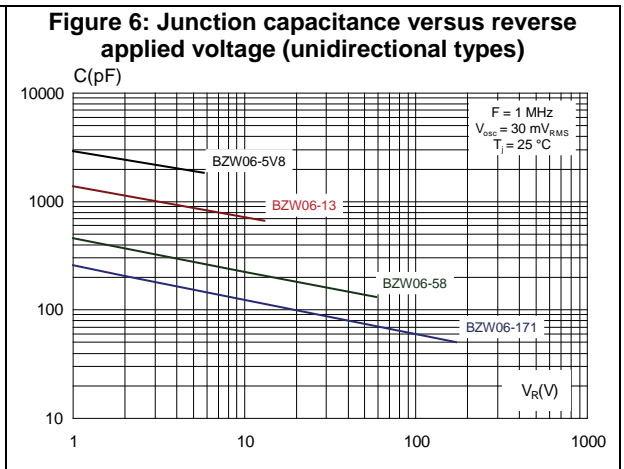
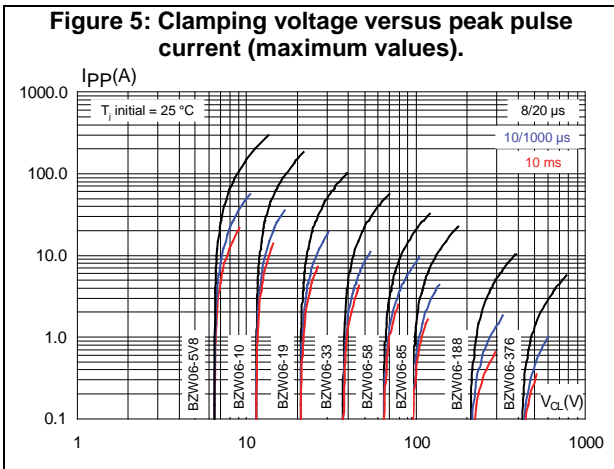
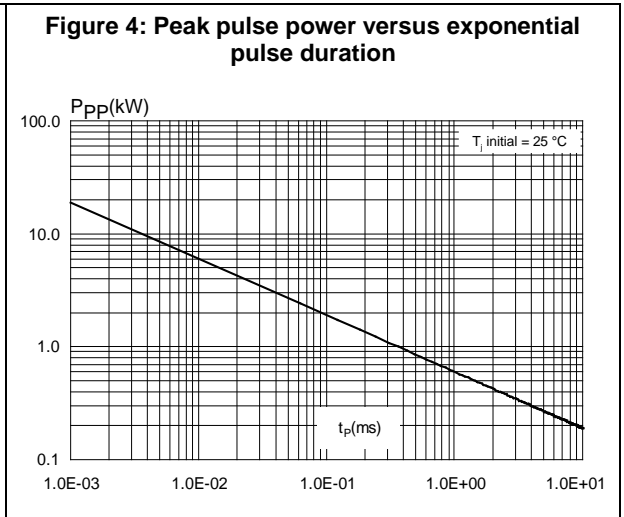
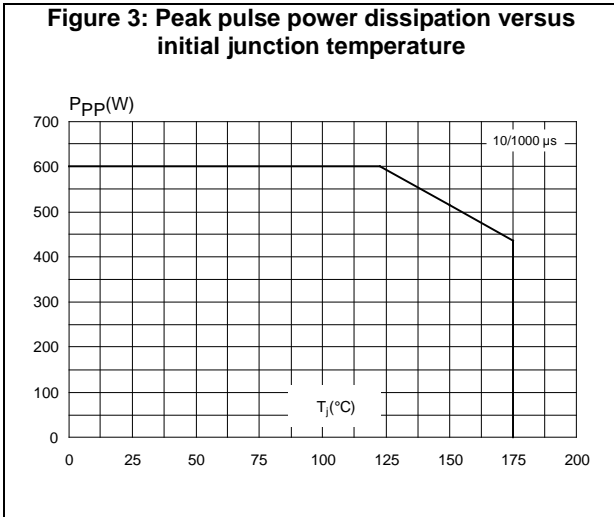
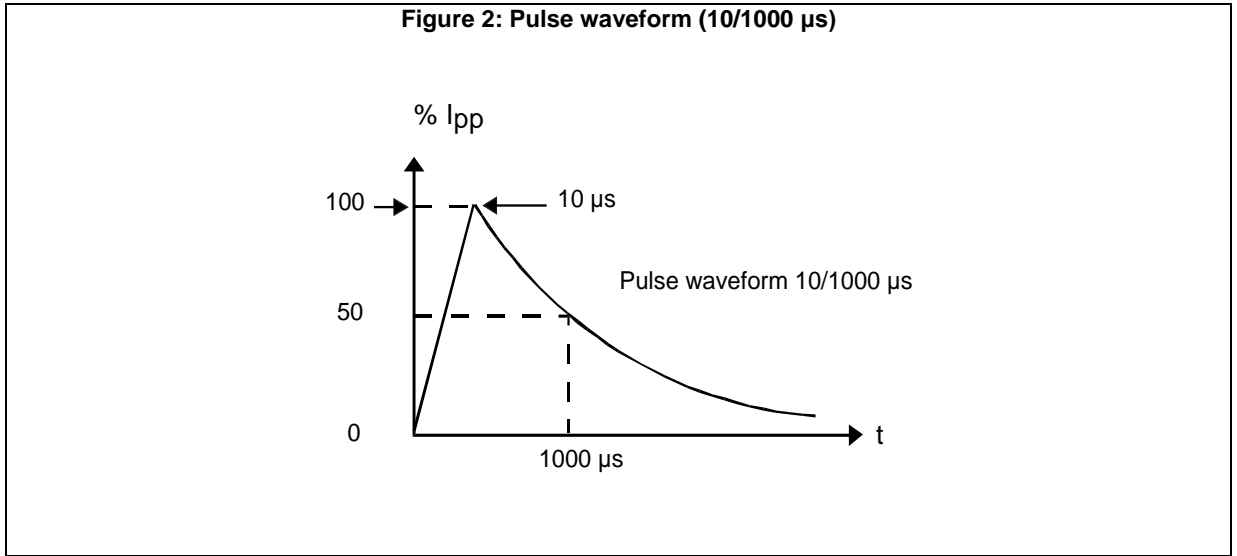

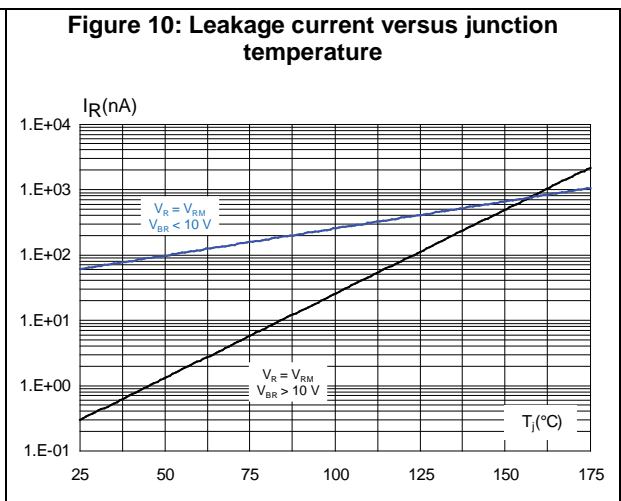
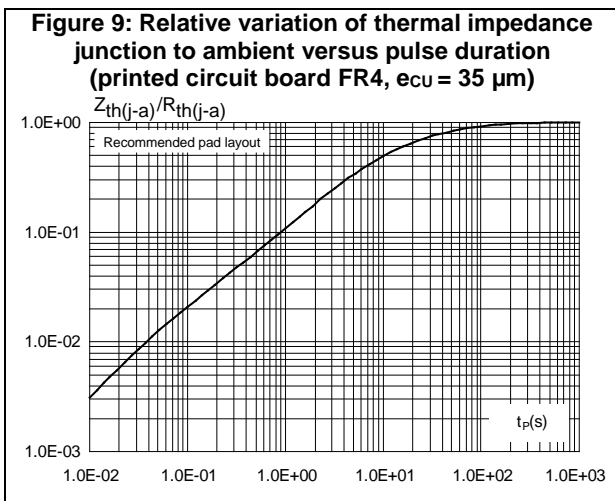
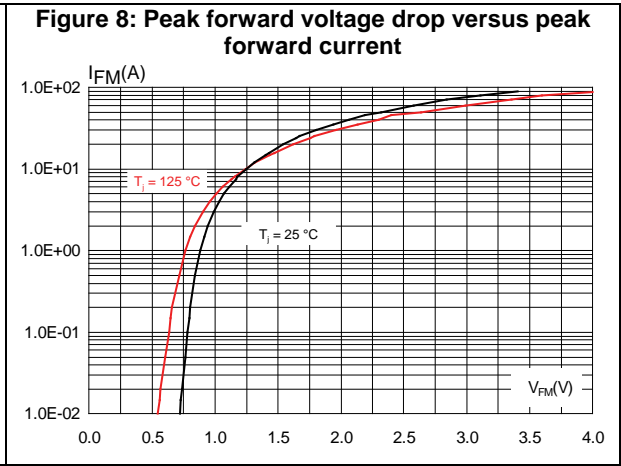
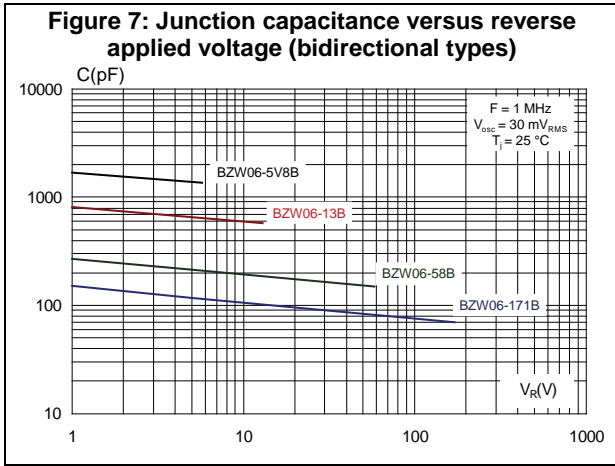

2 Package information

In order to meet environmental requirements, ST offers these devices in different grades of ECOPACK® packages, depending on their level of environmental compliance. ECOPACK® specifications, grade definitions and product status are available at: www.st.com. ECOPACK® is an ST trademark.

2.1 DO-15 package information

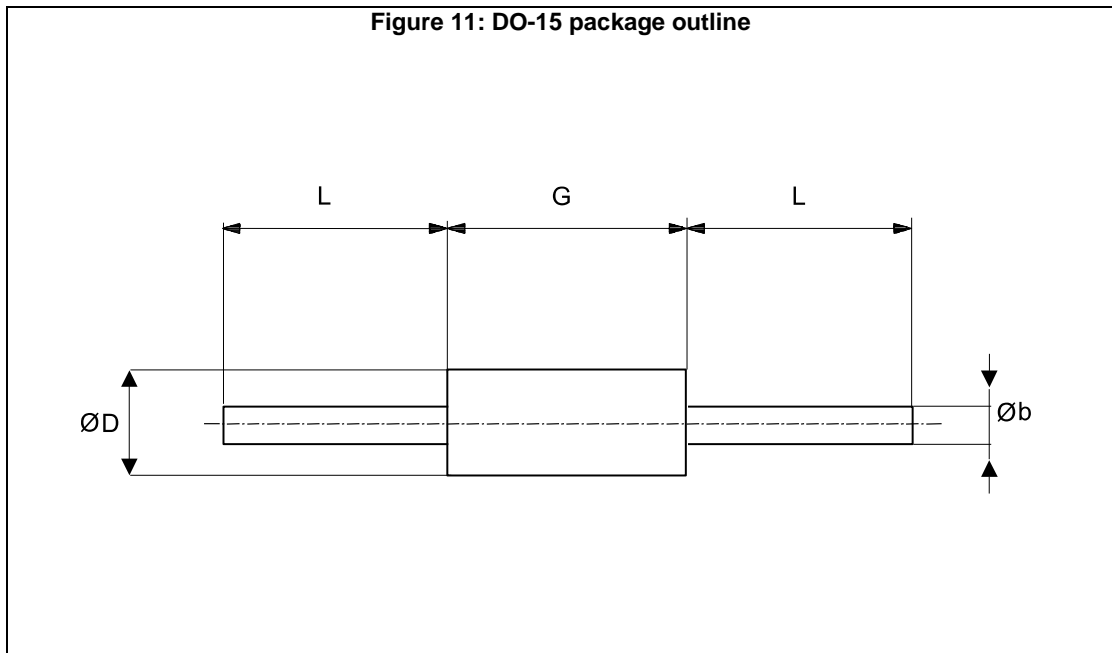

Table 5: DO-15 package mechanical data

Ref.	Dimensions					
	Millimeters			Inches		
	Min.	Typ.	Max.	Min.	Typ.	Max.
b	0.71	-	0.88	0.028	-	0.035
D	2.95	-	3.53	0.116	-	0.139
G	6.05	-	6.75	0.238	-	0.266
L	26	-	31	1.024	-	1.22

3 Ordering information

Figure 12: Ordering information scheme

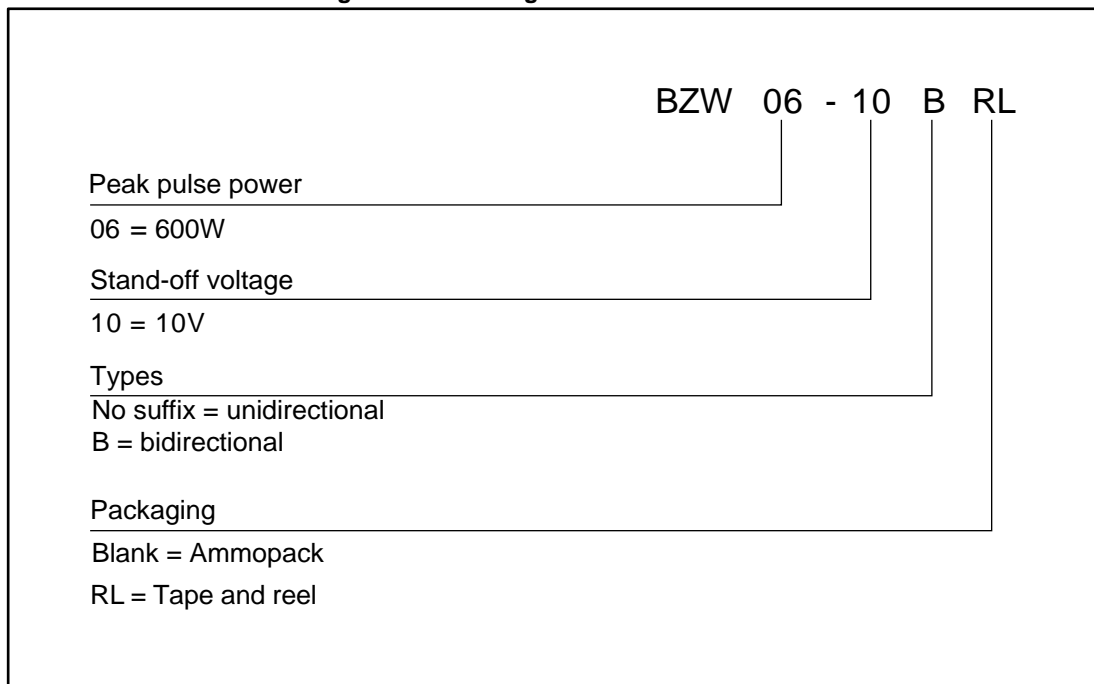

Table 6: Ordering information

Order code	Marking ⁽¹⁾	Package	Weight	Base qty.	Delivery mode
BZW-06xxxx	See Table 4	DO-15	0.4 g	1000	Ammopack
BZW-06xxxxRL				6000	Tape and reel

Notes:

⁽¹⁾Marking: logo, data code, type, cathode band (for unidirectional types only)

4 Revision history

Table 7: Document revision history

Date	Revision	Changes
Feb-2003	3A	Last update.
06-Apr-2017	4	Updated <i>Table 2: "Absolute maximum ratings ($T_{amb} = 25\text{ °C}$)"</i> , <i>Table 4: "Electrical characteristics ($T_{amb} = 25\text{ °C}$)"</i> , <i>Section 5.1: "Characteristics (curves)"</i> and <i>Section 6.1: "DO-15 package information"</i> .

IMPORTANT NOTICE – PLEASE READ CAREFULLY

STMicroelectronics NV and its subsidiaries ("ST") reserve the right to make changes, corrections, enhancements, modifications, and improvements to ST products and/or to this document at any time without notice. Purchasers should obtain the latest relevant information on ST products before placing orders. ST products are sold pursuant to ST's terms and conditions of sale in place at the time of order acknowledgement.

Purchasers are solely responsible for the choice, selection, and use of ST products and ST assumes no liability for application assistance or the design of Purchasers' products.

No license, express or implied, to any intellectual property right is granted by ST herein.

Resale of ST products with provisions different from the information set forth herein shall void any warranty granted by ST for such product.



ST and the ST logo are trademarks of ST. All other product or service names are the property of their respective owners.

Information in this document supersedes and replaces information previously supplied in any prior versions of this document.

© 2017 STMicroelectronics – All rights reserved

Looking for pricing, stock, or lifecycle information?

Click below to explore more details on WIN SOURCE:

-  [View BZW06-33 on WIN SOURCE](#)
-  [STMicroelectronics Information](#)

Optimize Your Supply Chain with WIN SOURCE Solutions

-  Global Sourcing Solution
-  Obsolete Management
-  Cost Control Management
-  Shortage Management
-  Alternative Solution
-  Excess Inventory Management