

Operational Amplifiers

# Ground Sense Operational Amplifiers

BA10358xx, BA10324Axx, BA2904xxx, BA2904Sxxx, BA2904Wxx  
BA2902xx, BA2902Sxx

### General Description

General purpose BA10358 / BA10324A and high reliability BA2904 / BA2902 integrate two or four independent Op-Amps on a single chip and have some features of high-gain, low power consumption, and wide operating voltage range of 3V to 36V (single power supply).

BA2904W have low input offset voltage(2mV max.).

### Features

- Operable with a single power supply
- Wide operating supply voltage range
- Input and output are operable GND sense
- Low supply current
- High open loop voltage gain
- Wide temperature range

### Application

- Current sense application
- Buffer application amplifier
- Active filter
- Consumer electronics

### Key Specification

- Wide Operating Supply Voltage (single supply):
 

BA10358/BA10324A	+3.0V to +32.0V
BA2904/BA2902	+3.0V to +36.0V
- Wide Temperature Range:
 

BA10358/ BA10324A	-40°C~+85°C
BA2904S/ BA2902S	-40°C~+105°C
BA2904/ BA2902	-40°C~+125°C
BA2904W	-40°C~+125°C
- Input Offset Voltage:
 

BA10358/ BA10324A	7mV (Max)
BA2904S/ BA2902S	7mV (Max)
BA2904/ BA2902	7mV (Max)
BA2904W	2mV (Max)
- Low Input Bias Current:
 

BA10358	45nA (Typ)
BA10324A	20nA (Typ)
BA2904S/ BA2902S	20nA (Typ)
BA2904/ BA2902	20nA (Typ)
BA2904W	20nA (Typ)

### Packages

	W(Typ) x D(Typ) x H(Max)
SOP8	5.00mm x 6.20mm x 1.71mm
SOP-J8	4.90mm x 6.00mm x 1.65mm
SSOP-B8	3.00mm x 6.40mm x 1.35mm
MSOP8	2.90mm x 4.00mm x 0.90mm
SOP14	8.70mm x 6.20mm x 1.71mm
SOP-J14	8.65mm x 6.00mm x 1.65mm
SSOP-B14	5.00mm x 6.40mm x 1.35mm

### Selection Guide

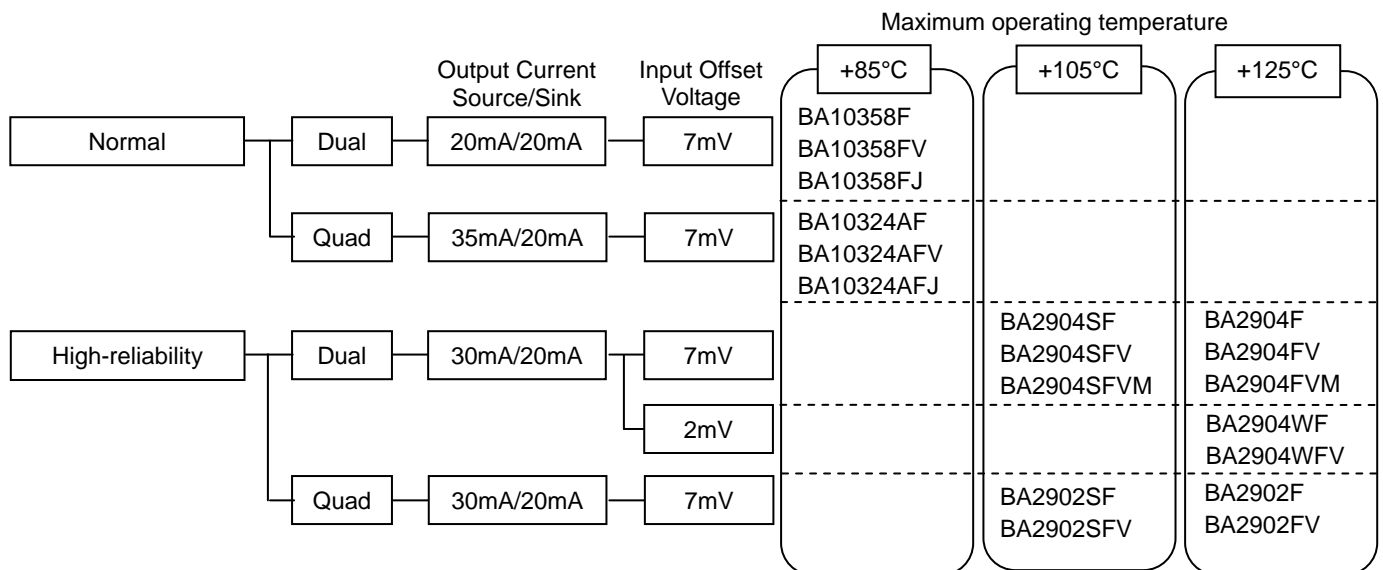

○Product structure : Silicon monolithic integrated circuit ○This product is not designed protection against radioactive rays.

Simplified schematic

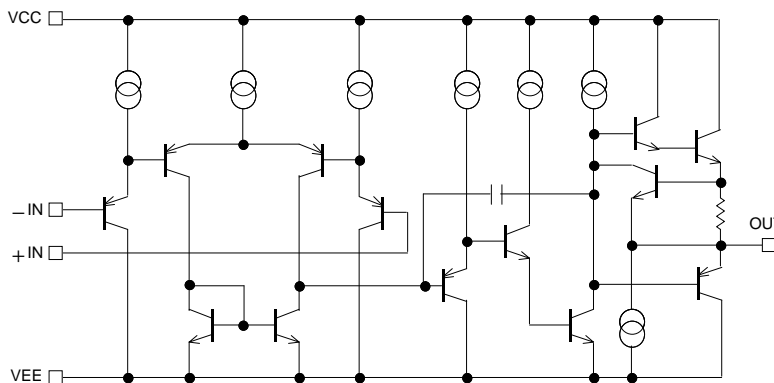
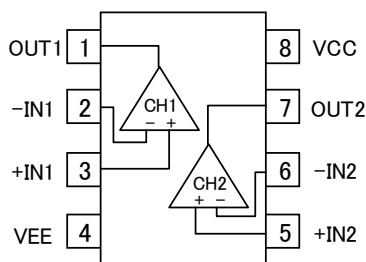

Figure 1. Simplified schematic (one channel only)

Pin Configuration

BA10358F,BA2904SF,BA2904F,BA2904WF :SOP8  
 BA10358FV,BA2904SFV,BA2904FV,BA2904WFV :SSOP-B8  
 BA2904SFVM,BA2904FVM :MSOP8  
 BA10358FJ :SOP-J8



Pin No.	Pin Name
1	OUT1
2	-IN1
3	+IN1
4	VEE
5	+IN2
6	-IN2
7	OUT2
8	VCC

BA10324AF,BA2902SF,BA2902F :SOP14  
 BA10324AFV,BA2902SFV,BA2902FV :SSOP-B14  
 BA10324AFJ :SOP-J14

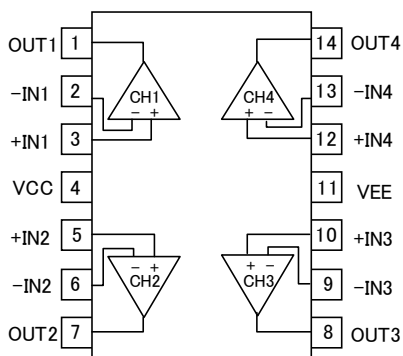

Pin No.	Pin Name
1	OUT1
2	-IN1
3	+IN1
4	VCC
5	+IN2
6	-IN2
7	OUT2
8	OUT3
9	-IN3
10	+IN3
11	VEE
12	+IN4
13	-IN4
14	OUT4

Package						
SOP8	SSOP-B8	MSOP8	SOP-J8	SOP14	SSOP-B14	SOP-J14
BA10358F BA2904SF BA2904F BA2904WF	BA10358FV BA2904SFV BA2904FV BA2904WV	BA2904SFVM BA2904FVM	BA10358FJ	BA10324AF BA2902SF BA2902F	BA10324AFV BA2902SFV BA2902FV	BA10324AFJ

Ordering Information

B A x x x x x x x x - x x

Part Number.

BA10358xx  
 BA10324Axx  
 BA2904xxx  
 BA2904Sxxx  
 BA2904Wxx  
 BA2902xx  
 BA2902Sxx

Package

F : SOP8  
       SOP14  
 FV : SSOP-B8  
       SSOP-B14  
 FVM : MSOP8  
 FJ : SOP-J8  
       SOP-J14

Packaging and forming specification

E2: Embossed tape and reel  
 (SOP8/SOP14/SSOP-B8/  
       SSOP-B14/SOP-J8/SOP-J14)  
 TR: Embossed tape and reel  
 (MSOP8)

Line-up

Topr	Input Offset Voltage (Max)	Supply Current (Typ)	Package		Orderable Part Number	
			Package	Reel of		
-40°C to +85°C	7mV	0.5mA	SOP8	2500	BA10358F-E2	
			SOP-J8	2500	BA10358FJ-E2	
			SSOP-B8	2500	BA10358FV-E2	
		0.6mA	SOP14	2500	BA10324AF-E2	
			SOP-J14	2500	BA10324AFJ-E2	
			SSOP-B14	2500	BA10324AFV-E2	
-40°C to +105°C	7mV	0.5mA	SOP8	2500	BA2904SF-E2	
			SSOP-B8	2500	BA2904SFV-E2	
			MSOP8	3000	BA2904SFVM-TR	
		0.7mA	SOP14	2500	BA2902SF-E2	
			SSOP-B14	2500	BA2902SFV-E2	
-40°C to +125°C	7mV	0.5mA	SOP8	2500	BA2904F-E2	
			SSOP-B8	2500	BA2904FV-E2	
			MSOP8	3000	BA2904FVM-TR	
		0.7mA	SOP14	2500	BA2902F-E2	
			SSOP-B14	2500	BA2902FV-E2	
		2mV	0.5mA	SOP8	2500	BA2904WF-E2
				SSOP-B8	2500	BA2904WV-E2

**Absolute Maximum Ratings** ( $T_A=25^\circ\text{C}$ )

OBA10358, BA10324A

Parameter	Symbol	Ratings	Unit	
Supply Voltage	VCC-VEE	+32	V	
Power dissipation	$P_D$	SOP8	620 <sup>(Note 1,7)</sup>	mW
		SOP-J8	540 <sup>(Note 2,7)</sup>	
		SSOP-B8	500 <sup>(Note 3,7)</sup>	
		SOP14	450 <sup>(Note 4,7)</sup>	
		SOP-J14	820 <sup>(Note 5,7)</sup>	
		SSOP-B14	700 <sup>(Note 6,7)</sup>	
Differential Input Voltage <sup>(Note 8)</sup>	$V_{ID}$	+32	V	
Input Common-mode Voltage Range	$V_{ICM}$	(VEE-0.3) to (VEE+32)	V	
Input Current <sup>(Note 9)</sup>	$I_I$	-10	mA	
Wide Operating Supply Voltage	$V_{opr}$	+3.0 to +32.0	V	
Operating Temperature Range	$T_{opr}$	-40 to +85	$^\circ\text{C}$	
Storage Temperature Range	$T_{stg}$	-55 to +125	$^\circ\text{C}$	
Maximum Junction Temperature	$T_{Jmax}$	+125	$^\circ\text{C}$	

Note: Absolute maximum rating item indicates the condition which must not be exceeded. Application if voltage in excess of absolute maximum rating or use out of absolute maximum rated temperature environment may cause deterioration of characteristics.

(Note 1) To use at temperature above  $T_A=25^\circ\text{C}$  reduce 6.2mW.

(Note 2) To use at temperature above  $T_A=25^\circ\text{C}$  reduce 5.4mW

(Note 3) To use at temperature above  $T_A=25^\circ\text{C}$  reduce 5.0mW.

(Note 4) To use at temperature above  $T_A=25^\circ\text{C}$  reduce 4.5mW.

(Note 5) To use at temperature above  $T_A=25^\circ\text{C}$  reduce 8.2mW

(Note 6) To use at temperature above  $T_A=25^\circ\text{C}$  reduce 7.0mW.

(Note 7) Mounted on a FR4 glass epoxy PCB 70mmx70mmx1.6mm (Copper foil area less than 3%).

(Note 8) The voltage difference between inverting input and non-inverting input is the differential input voltage.

Then input terminal voltage is set to more than VEE.

(Note 9) An excessive input current will flow when input voltages of less than VEE-0.6V are applied.

The input current can be set to less than the rated current by adding a limiting resistor.

**Caution:** Operating the IC over the absolute maximum ratings may damage the IC. The damage can either be a short circuit between pins or an open circuit between pins and the internal circuitry. Therefore, it is important to consider circuit protection measures, such as adding a fuse, in case the IC is operated over the absolute maximum ratings.

**Absolute Maximum Ratings** ( $T_A=25^\circ\text{C}$ )

OBA2904, BA2902

Parameter	Symbol		Ratings		Unit
			BA2904S BA2902S	BA2904, BA2904W BA2902	
Supply Voltage	VCC-VEE		+36		V
Power dissipation	$P_D$	SOP8	775 <sup>(Note 10,15)</sup>		mW
		SSOP-B8	625 <sup>(Note 11,15)</sup>		
		MSOP8	600 <sup>(Note 12,15)</sup>		
		SOP14	560 <sup>(Note 13,15)</sup>		
		SSOP-B14	870 <sup>(Note 14,15)</sup>		
Differential Input Voltage <sup>(Note 16)</sup>	$V_{ID}$		+36		V
Input Common-mode Voltage Range	$V_{ICM}$		(VEE-0.3) to (VEE+36)		V
Input Current <sup>(Note 17)</sup>	$I_I$		-10		mA
Wide Operating Supply Voltage	$V_{opr}$		+3.0 to +36.0		V
Operating Temperature Range	$T_{opr}$		-40 to +105	-40 to +125	$^\circ\text{C}$
Storage Temperature Range	$T_{stg}$		-55 to +150		$^\circ\text{C}$
Maximum Junction Temperature	$T_{Jmax}$		+150		$^\circ\text{C}$

(Note 10) To use at temperature above  $T_A=25^\circ\text{C}$  reduce 6.2mW.

(Note 11) To use at temperature above  $T_A=25^\circ\text{C}$  reduce 5.0mW.

(Note 12) To use at temperature above  $T_A=25^\circ\text{C}$  reduce 4.8mW.

(Note 13) To use at temperature above  $T_A=25^\circ\text{C}$  reduce 4.5mW.

(Note 14) To use at temperature above  $T_A=25^\circ\text{C}$  reduce 7.0mW.

(Note 15) Mounted on a FR4 glass epoxy PCB 70mm×70mm×1.6mm (Copper foil area less than 3%).

(Note 16) The voltage difference between inverting input and non-inverting input is the differential input voltage.

Then input terminal voltage is set to more than VEE.

(Note 17) An excessive input current will flow when input voltages of less than VEE-0.6V are applied.

The input current can be set to less than the rated current by adding a limiting resistor.

**Caution:** Operating the IC over the absolute maximum ratings may damage the IC. The damage can either be a short circuit between pins or an open circuit between pins and the internal circuitry. Therefore, it is important to consider circuit protection measures, such as adding a fuse, in case the IC is operated over the absolute maximum ratings.

**Electrical Characteristics**

OBA10358 (Unless otherwise specified VCC=+5V, VEE=0V, T<sub>A</sub>=25°C)

Parameter	Symbol	Limits			Unit	Condition
		Min.	Typ.	Max.		
Input Offset Voltage <sup>(Note 18)</sup>	V <sub>IO</sub>	-	2	7	mV	OUT=1.4V
Input Offset Current <sup>(Note 18)</sup>	I <sub>IO</sub>	-	5	50	nA	OUT=1.4V
Input Bias Current <sup>(Note 19)</sup>	I <sub>B</sub>	-	45	250	nA	OUT=1.4V
Supply Current	I <sub>CC</sub>	-	0.5	1.2	mA	RL=∞, All Op-Amps
Maximum Output Voltage(High)	V <sub>OH</sub>	3.5	-	-	V	RL=2kΩ
Maximum Output Voltage(Low)	V <sub>OL</sub>	-	-	250	mV	RL=∞, All Op-Amps
Large Signal Voltage Gain	A <sub>V</sub>	25	100	-	V/mV	RL ≥ 2kΩ, VCC=15V OUT=1.4 to 11.4V
		88	100	-	dB	
Input Common-mode Voltage Range	V <sub>ICM</sub>	0	-	VCC-1.5	V	(VCC-VEE)=5V OUT=VEE+1.4V
Common-mode Rejection Ratio	CMRR	65	80	-	dB	OUT=1.4V
Power Supply Rejection Ratio	PSRR	65	100	-	dB	VCC=5 to 30V
Output Source Current	I <sub>SOURCE</sub>	10	20	-	mA	VIN+=1V, VIN-=0V OUT=0V, 1CH is short circuit
Output Sink Current	I <sub>SINK</sub>	10	20	-	mA	VIN+=0V, VIN-=1V OUT=5V, 1CH is short circuit
Channel Separation	CS	-	120	-	dB	f=1kHz, input referred
Slew Rate	SR	-	0.2	-	V/μs	VCC=15V, Av=0dB RL=2kΩ, CL=100pF
Gain Band Width	GBW	-	0.5	-	MHz	VCC=30V, RL=2kΩ CL=100pF

(Note 18) Absolute value

(Note 19) Current direction: Since first input stage is composed with PNP transistor, input bias current flows out of IC.

OBA10324A (Unless otherwise specified VCC=+5V, VEE=0V, TA=25°C)

Parameter	Symbol	Limits			Unit	Condition
		Min.	Typ.	Max.		
Input Offset Voltage <sup>(Note 20)</sup>	V <sub>IO</sub>	-	2	7	mV	OUT=1.4V
Input Offset Current <sup>(Note 20)</sup>	I <sub>IO</sub>	-	5	50	nA	OUT=1.4V
Input Bias Current <sup>(Note 21)</sup>	I <sub>B</sub>	-	20	250	nA	OUT=1.4V
Supply Current	I <sub>CC</sub>	-	0.6	2	mA	RL=∞, All Op-Amps
Maximum Output Voltage(High)	V <sub>OH</sub>	3.5	-	-	V	RL=2kΩ
Maximum Output Voltage(Low)	V <sub>OL</sub>	-	-	250	mV	RL=∞, All Op-Amps
Large Signal Voltage Gain	A <sub>v</sub>	25	100	-	V/mV	RL ≥ 2kΩ, VCC=15V OUT=1.4 to 11.4V
		88	100	-	dB	
Input Common-mode Voltage range	V <sub>ICM</sub>	0	-	VCC-1.5	V	(VCC-VEE)=5V OUT=VEE+1.4V
Common-mode Rejection Ratio	CMRR	65	75	-	dB	OUT=1.4V
Power Supply Rejection Ratio	PSRR	65	100	-	dB	VCC=5 to 30V
Output Source Current	I <sub>SOURCE</sub>	20	35	-	mA	VIN+=1V, VIN-=0V OUT=0V, 1CH is short circuit
Output Sink Current	I <sub>SINK</sub>	10	20	-	mA	VIN+=0V, VIN-=1V OUT=5V, 1CH is short circuit
Channel Separation	CS	-	120	-	dB	f=1kHz, input referred
Slew Rate	SR	-	0.2	-	V/μs	VCC=15V, Av=0dB RL=2kΩ, CL=100pF
Gain Band Width	GBW	-	0.5	-	MHz	VCC=30V, RL=2kΩ CL=100pF

(Note 20) Absolute value

(Note 21) Current direction: Since first input stage is composed with PNP transistor, input bias current flows out of IC.

OBA2904, BA2904S (Unless otherwise specified VCC=+5V, VEE=0V)

Parameter	Symbol	Temperature Range	Limits			Unit	Condition
			Min.	Typ.	Max.		
Input Offset Voltage <sup>(Note 22,23)</sup>	V <sub>IO</sub>	25°C	-	2	7	mV	OUT=1.4V
		Full range	-	-	10		VCC=5 to 30V, OUT=1.4V
Input Offset Voltage Drift	ΔV <sub>IO</sub> / ΔT	-	-	±7	-	μV/°C	OUT=1.4V
Input Offset Current <sup>(Note 22,23)</sup>	I <sub>IO</sub>	25°C	-	2	50	nA	OUT=1.4V
		Full range	-	-	200		
Input Offset Current Drift	ΔI <sub>IO</sub> / ΔT	-	-	±10	-	pA/°C	OUT=1.4V
Input Bias Current <sup>(Note 22,23)</sup>	I <sub>B</sub>	25°C	-	20	250	nA	OUT=1.4V
		Full range	-	-	250		
Supply Current <sup>(Note 23)</sup>	I <sub>CC</sub>	25°C	-	0.5	1.2	mA	RL=∞, All Op-Amps
		Full range	-	-	2		
Maximum Output Voltage(High) <sup>(Note 23)</sup>	V <sub>OH</sub>	25°C	3.5	-	-	V	RL=2kΩ
		Full range	27	28	-		VCC=30V, RL=10kΩ
Maximum Output Voltage(Low) <sup>(Note 23)</sup>	V <sub>OL</sub>	Full range	-	5	20	mV	RL=∞, All Op-Amps
Large Signal Voltage Gain	A <sub>V</sub>	25°C	25	100	-	V/mV	RL ≥ 2kΩ, VCC=15V OUT=1.4 to 11.4V
			88	100	-	dB	
Input Common-mode Voltage Range	V <sub>ICM</sub>	25°C	0	-	VCC-1.5	V	(VCC-VEE)=5V OUT=VEE+1.4V
Common-mode Rejection Ratio	CMRR	25°C	50	80	-	dB	OUT=1.4V
Power Supply Rejection Ratio	PSRR	25°C	65	100	-	dB	VCC=5 to 30V
Output Source Current <sup>(Note 23,24)</sup>	I <sub>SOURCE</sub>	25°C	20	30	-	mA	VIN+=1V, VIN-=0V OUT=0V, 1CH is short circuit
		Full range	10	-	-		
Output Sink Current <sup>(Note 23,24)</sup>	I <sub>SINK</sub>	25°C	10	20	-	mA	VIN+=0V, VIN-=1V OUT=5V, 1CH is short circuit
		Full range	2	-	-		
		25°C	12	40	-	μA	VIN+=0V, VIN-=1V OUT=200mV
Channel Separation	CS	25°C	-	120	-	dB	f=1kHz, input referred
Slew rate	SR	25°C	-	0.2	-	V/μs	VCC=15V, Av=0dB RL=2kΩ, CL=100pF
Gain Band Width	GBW	25°C	-	0.5	-	MHz	VCC=30V, RL=2kΩ CL=100pF
Input referred noise voltage	V <sub>N</sub>	25°C	-	40	-	nV/√Hz	VCC=15V, VEE=-15V RS=100Ω, Vi=0V, f=1kHz

(Note 22) Absolute value

(Note 23) BA2904S :Full range -40 to +105°C BA2904 :Full range -40 to +125°C

(Note 24) Under high temperatures, please consider the power dissipation when selecting the output current.

When the output terminal is continuously shorted the output current reduces the internal temperature by flushing.

OBA2904W (Unless otherwise specified VCC=+5V, VEE=0V)

Parameter	Symbol	Temperature Range	Limits			Unit	Condition
			Min.	Typ.	Max.		
Input Offset Voltage <sup>(Note 25)</sup>	$V_{IO}$	25°C	-	0.5	2	mV	OUT=1.4V
Input Offset Voltage Drift	$\Delta V_{IO}/\Delta T$	-	-	±7	-	µV/°C	OUT=1.4V
Input Offset Current <sup>(Note 25)</sup>	$I_{IO}$	25°C	-	2	50	nA	OUT=1.4V
Input Offset Current Drift	$\Delta I_{IO}/\Delta T$	-	-	±10	-	pA/°C	OUT=1.4V
Input Bias Current <sup>(Note 25)</sup>	$I_B$	25°C	-	20	250	nA	OUT=1.4V
		Full range	-	-	250		
Supply Current	$I_{CC}$	25°C	-	0.5	1.2	mA	RL=∞, All Op-Amps
		Full range	-	-	1.2		
Maximum Output Voltage(High)	$V_{OH}$	25°C	3.5	-	-	V	RL=2kΩ
		Full range	27	28	-		VCC=30V, RL=10kΩ
Maximum Output Voltage(Low)	$V_{OL}$	Full range	-	5	20	mV	RL=∞, All Op-Amps
Large Signal Voltage Gain	$A_V$	25°C	25	100	-	V/mV	RL≥2kΩ, VCC=15V OUT=1.4 to 11.4V
			88	100	-	dB	
Input Common-mode Voltage Range	$V_{ICM}$	25°C	0	-	VCC-1.5	V	(VCC-VEE)=5V OUT=VEE+1.4V
Common-mode Rejection Ratio	CMRR	25°C	50	80	-	dB	OUT=1.4V
Power Supply Rejection Ratio	PSRR	25°C	65	100	-	dB	VCC=5 to 30V
Output Source Current <sup>(Note 26)</sup>	$I_{SOURCE}$	25°C	20	30	-	mA	VIN+=1V, VIN-=0V OUT=0V, 1CH is short circuit
		Full range	10	-	-		
Output Sink Current <sup>(Note 26)</sup>	$I_{SINK}$	25°C	10	20	-	mA	VIN+=0V, VIN-=1V OUT=5V, 1CH is short circuit
		Full range	2	-	-		
		25°C	12	40	-	µA	VIN+=0V, VIN-=1V OUT=200mV
Channel Separation	CS	25°C	-	120	-	dB	f=1kHz, input referred
Slew rate	SR	25°C	-	0.2	-	V/µs	VCC=15V, Av=0dB RL=2kΩ, CL=100pF
Gain Band Width	GBW	25°C	-	0.5	-	MHz	VCC=30V, RL=2kΩ CL=100pF
Input referred noise voltage	$V_N$	25°C	-	40	-	nV/√Hz	VCC=15V, VEE=-15V RS=100Ω, Vi=0V, f=1kHz

(Note 25) Absolute value

(Note 26) Under high temperatures, please consider the power dissipation when selecting the output current.

When the output terminal is continuously shorted the output current reduces the internal temperature by flushing.

OBA2902, BA2902S (Unless otherwise specified VCC=+5V, VEE=0V)

Parameter	Symbol	Temperature Range	Limits			Unit	Condition
			Min.	Typ.	Max.		
Input Offset Voltage <sup>(Note 27,28)</sup>	V <sub>IO</sub>	25°C	-	2	7	mV	OUT=1.4V
		Full range	-	-	10		VCC=5 to 30V, OUT=1.4V
Input Offset Voltage Drift	$\Delta V_{IO}/\Delta T$	-	-	±7	-	µV/°C	OUT=1.4V
Input Offset Current <sup>(Note 27,28)</sup>	I <sub>IO</sub>	25°C	-	2	50	nA	OUT=1.4V
		Full range	-	-	200		
Input Offset Current Drift	$\Delta I_{IO}/\Delta T$	-	-	±10	-	pA/°C	OUT=1.4V
Input Bias Current <sup>(Note 27,28)</sup>	I <sub>B</sub>	25°C	-	20	250	nA	OUT=1.4V
		Full range	-	-	250		
Supply Current <sup>(Note 28)</sup>	I <sub>CC</sub>	25°C	-	0.7	2	mA	RL=∞, All Op-Amps
		Full range	-	-	3		
Maximum Output Voltage(High) <sup>(Note 28)</sup>	V <sub>OH</sub>	25°C	3.5	-	-	V	RL=2kΩ
		Full range	27	28	-		VCC=30V, RL=10kΩ
Maximum Output Voltage(Low) <sup>(Note 28)</sup>	V <sub>OL</sub>	Full range	-	5	20	mV	RL=∞, All Op-Amps
Large Signal Voltage Gain	A <sub>V</sub>	25°C	25	100	-	V/mV	RL ≥ 2kΩ, VCC=15V OUT=1.4 to 11.4V
			88	100	-		
Input Common-mode Voltage Range	V <sub>ICM</sub>	25°C	0	-	VCC-1.5	V	(VCC-VEE)=5V OUT=VEE+1.4V
Common-mode Rejection Ratio	CMRR	25°C	50	80	-	dB	OUT=1.4V
Power Supply Rejection Ratio	PSRR	25°C	65	100	-	dB	VCC=5 to 30V
Output Source Current <sup>(Note 28,29)</sup>	I <sub>SOURCE</sub>	25°C	20	30	-	mA	VIN+=1V, VIN-=0V OUT=0V 1CH is short circuit
		Full range	10	-	-		
Output Sink Current <sup>(Note 28,29)</sup>	I <sub>SINK</sub>	25°C	10	20	-	mA	VIN+=0V, VIN-=1V OUT=5V, 1CH is short circuit
		Full range	2	-	-		
		25°C	12	40	-	µA	VIN+=0V, VIN-=1V OUT=200mV
Channel Separation	CS	25°C	-	120	-	dB	f=1kHz, input referred
Slew rate	SR	25°C	-	0.2	-	V/µs	VCC=15V, Av=0dB RL=2kΩ, CL=100pF
Gain Band Width	GBW	25°C	-	0.5	-	MHz	VCC=30V, RL=2kΩ CL=100p
Input referred noise voltage	V <sub>N</sub>	25°C	-	40	-	nV/√Hz	VCC=15V, VEE=-15V RS=100Ω, Vi=0V, f=1kHz

(Note 27) Absolute value

(Note 28) BA2902S :Full range -40 to +105°C ,BA2902 :Full range -40 to +125°C

(Note 29) Under high temperatures, please consider the power dissipation when selecting the output current.

When the output terminal is continuously shorted the output current reduces the internal temperature by flushing.

## Description of Electrical Characteristics

Described below are descriptions of the relevant electrical terms used in this datasheet. Items and symbols used are also shown. Note that item name and symbol and their meaning may differ from those on another manufacturer's document or general document.

### 1. Absolute maximum ratings

Absolute maximum rating items indicate the condition which must not be exceeded. Application of voltage in excess of absolute maximum rating or use out of absolute maximum rated temperature environment may cause deterioration of characteristics.

- (1) Supply Voltage (VCC/VEE)  
Indicates the maximum voltage that can be applied between the positive power supply terminal and negative power supply terminal without deterioration or destruction of characteristics of internal circuit.
- (2) Differential Input Voltage ( $V_{ID}$ )  
Indicates the maximum voltage that can be applied between non-inverting and inverting terminals without damaging the IC.
- (3) Input Common-mode Voltage Range ( $V_{ICM}$ )  
Indicates the maximum voltage that can be applied to the non-inverting and inverting terminals without deterioration or destruction of electrical characteristics. Input common-mode voltage range of the maximum ratings does not assure normal operation of IC. For normal operation, use the IC within the input common-mode voltage range characteristics.
- (4) Power dissipation ( $P_D$ )  
Indicates the power that can be consumed by the IC when mounted on a specific board at the ambient temperature 25°C (normal temperature). As for package product,  $P_d$  is determined by the temperature that can be permitted by the IC in the package (maximum junction temperature) and the thermal resistance of the package.

### 2. Electrical characteristics

- (1) Input Offset Voltage ( $V_{IO}$ )  
Indicates the voltage difference between non-inverting terminal and inverting terminals. It can be translated into the input voltage difference required for setting the output voltage at 0 V.
- (2) Input Offset Voltage drift ( $\Delta V_{IO} / \Delta T$ )  
Denotes the ratio of the input offset voltage fluctuation to the ambient temperature fluctuation.
- (3) Input Offset Current ( $I_{IO}$ )  
Indicates the difference of input bias current between the non-inverting and inverting terminals.
- (4) Input Offset Current Drift ( $\Delta I_{IO} / \Delta T$ )  
Signifies the ratio of the input offset current fluctuation to the ambient temperature fluctuation.
- (4) Input Bias Current ( $I_B$ )  
Indicates the current that flows into or out of the input terminal. It is defined by the average of input bias currents at the non-inverting and inverting terminals.
- (5) Supply Current (ICC)  
Indicates the current that flows within the IC under specified no-load conditions.
- (7) Maximum Output Voltage(High) / Maximum Output Voltage(Low) (VOH/VOL)  
Indicates the voltage range of the output under specified load condition. It is typically divided into maximum output voltage High and low. Maximum output voltage high indicates the upper limit of output voltage. Maximum output voltage low indicates the lower limit.
- (8) Large Signal Voltage Gain ( $A_v$ )  
Indicates the amplifying rate (gain) of output voltage against the voltage difference between non-inverting terminal and inverting terminal. It is normally the amplifying rate (gain) with reference to DC voltage.  
 $A_v = (\text{Output voltage}) / (\text{Differential Input voltage})$
- (9) Input Common-mode Voltage Range ( $V_{ICM}$ )  
Indicates the input voltage range where IC normally operates.
- (10) Common-mode Rejection Ratio (CMRR)  
Indicates the ratio of fluctuation of input offset voltage when the input common mode voltage is changed. It is normally the fluctuation of DC.  
 $CMRR = (\text{Change of Input common-mode voltage}) / (\text{Input offset fluctuation})$

- (11) Power Supply Rejection Ratio (PSRR)  
Indicates the ratio of fluctuation of input offset voltage when supply voltage is changed.  
It is normally the fluctuation of DC.  
 $PSRR = (\text{Change of power supply voltage}) / (\text{Input offset fluctuation})$
- (12) Output Source Current/ Output Sink Current ( $I_{\text{source}} / I_{\text{sink}}$ )  
The maximum current that can be output from the IC under specific output conditions. The output source current indicates the current flowing out from the IC, and the output sink current indicates the current flowing into the IC.  
indicates the current flowing out from the IC, and the output sink current indicates the current flowing into the IC.
- (13) Channel Separation (CS)  
Indicates the fluctuation in the output voltage of the driven channel with reference to the change of output voltage of the channel which is not driven.
- (14) Slew Rate (SR)  
Indicates the ratio of the change in output voltage with time when a step input signal is applied.
- (15) Gain Bandwidth (GBW)  
The product of the open-loop voltage gain and the frequency at which the voltage gain decreases 6dB/octave.
- (16) Input Referred Noise Voltage ( $V_N$ )  
Indicates a noise voltage generated inside the operational amplifier equivalent by ideal voltage source connected in series with input terminal.

Typical Performance Curves

OBA10358

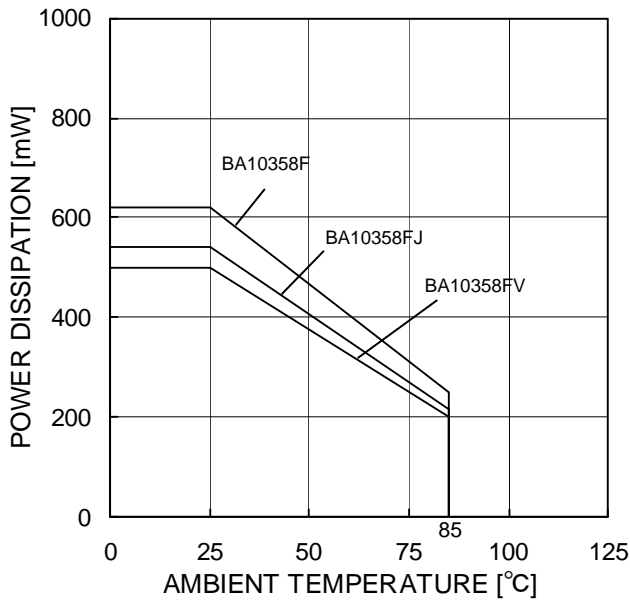

Figure 2.  
Derating Curve

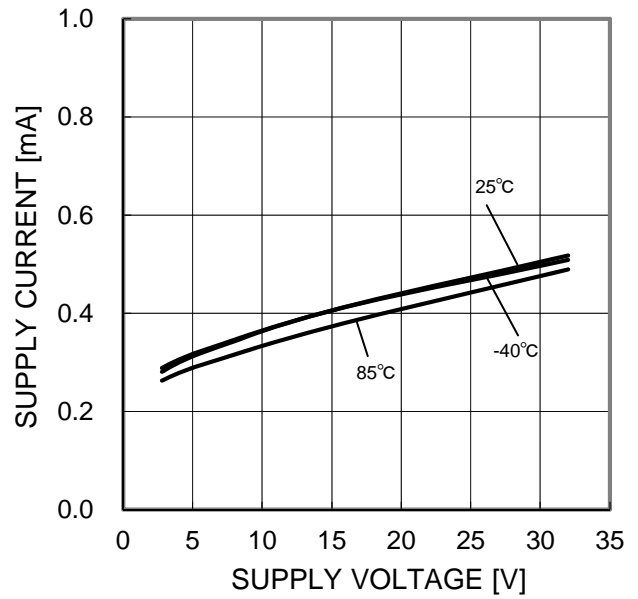

Figure 3.  
Supply Current – Supply Voltage

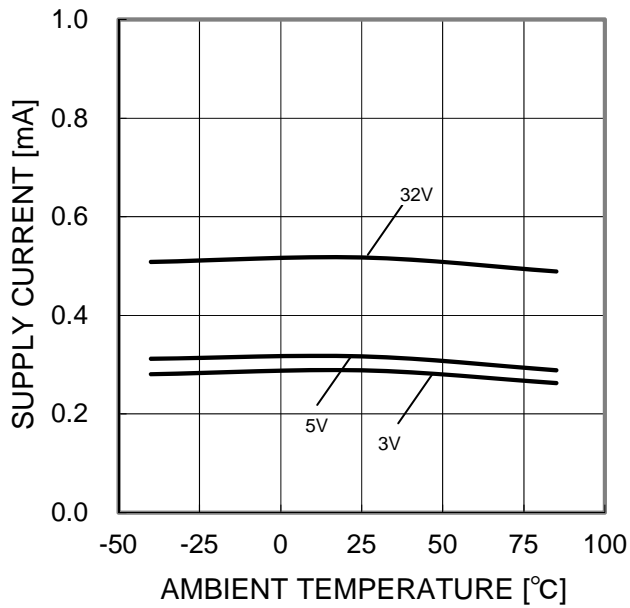

Figure 4.  
Supply Current – Ambient Temperature

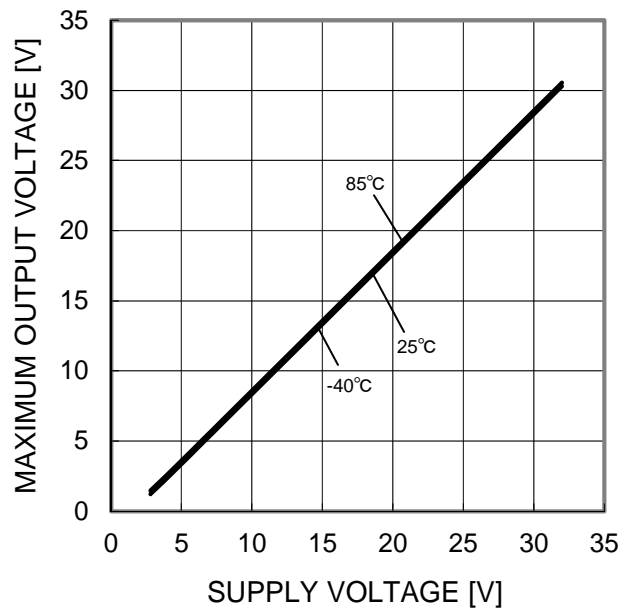

Figure 5.  
Maximum Output Voltage - Supply Voltage  
(RL=10kΩ)

(\*) The above data is measurement value of typical sample, it is not guaranteed.

OBA10358

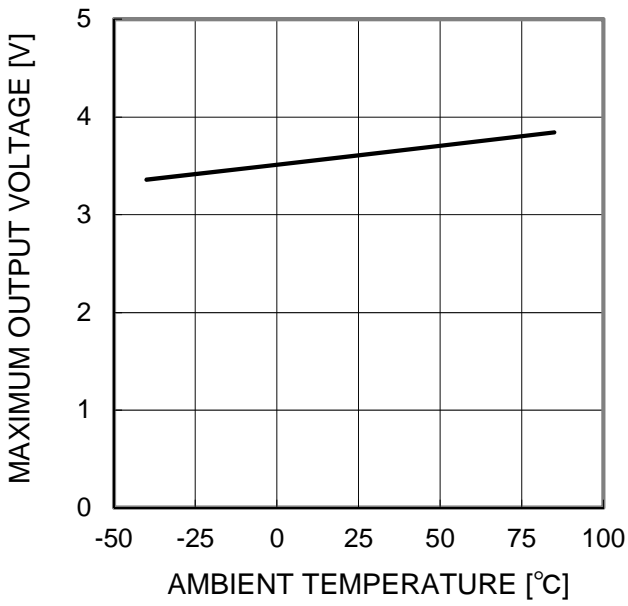

Figure 6.  
 Maximum Output Voltage - Ambient Temperature  
 (VCC=5V, RL=2kΩ)

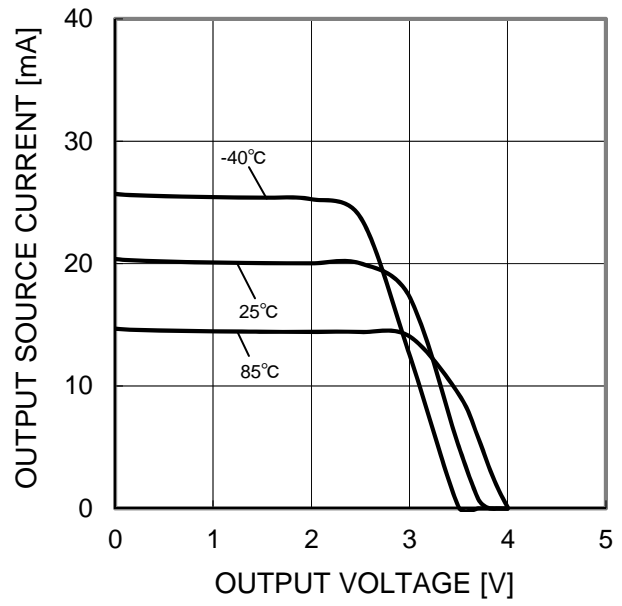

Figure 7.  
 Output Source Current - Output Voltage  
 (VCC=5V)

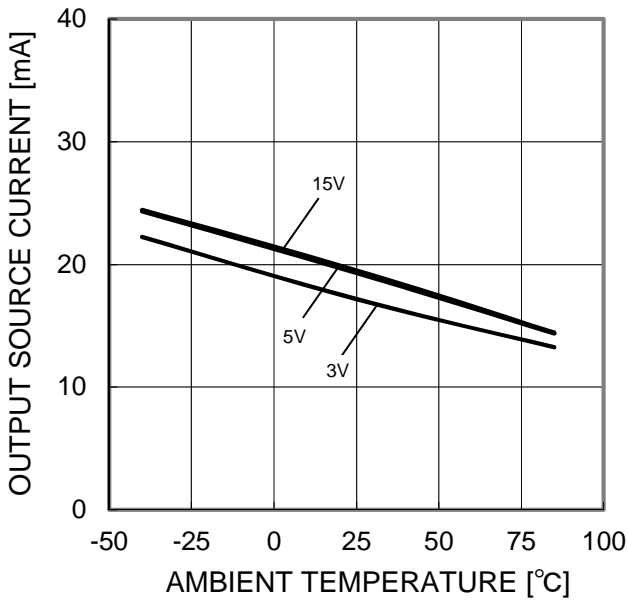

Figure 8.  
 Output Source Current - Ambient Temperature  
 (OUT=0V)

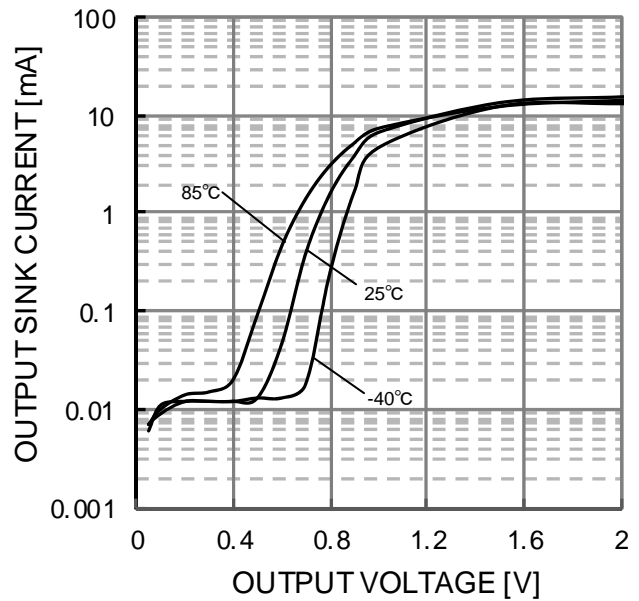

Figure 9.  
 Output Sink Current - Output Voltage  
 (VCC=5V)

(\*) The above data is measurement value of typical sample, it is not guaranteed.

OBA10358

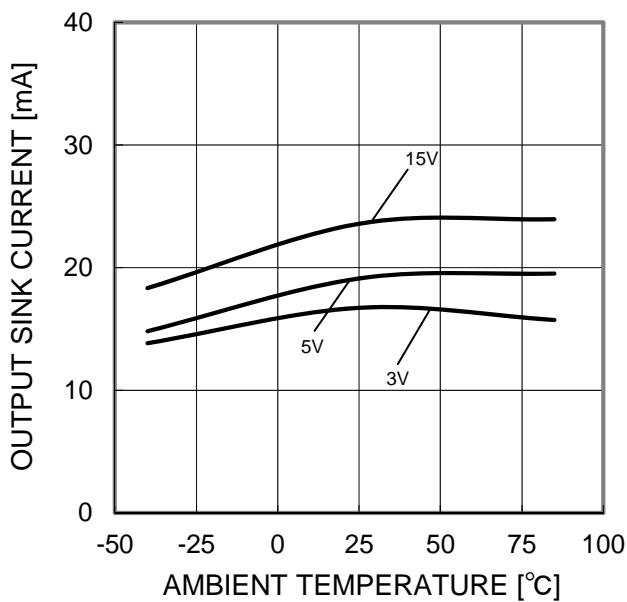

Figure 10.  
 Output Sink Current - Ambient Temperature  
 (OUT=VCC)

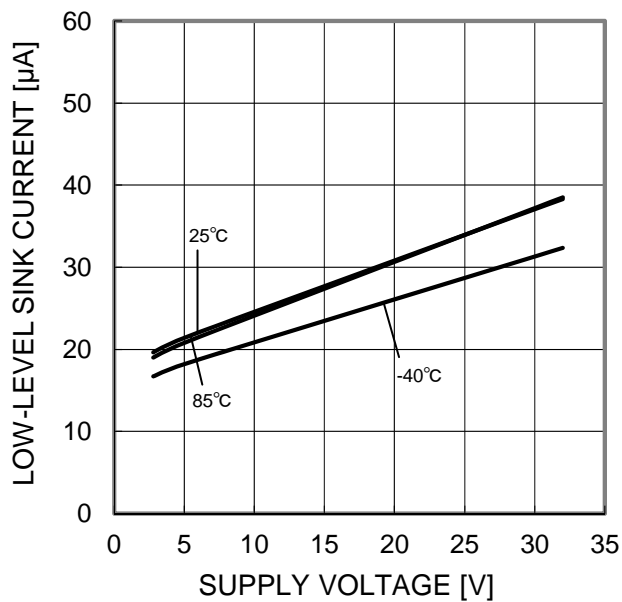

Figure 11.  
 Low Level Sink Current - Supply Voltage  
 (OUT=0.2V)

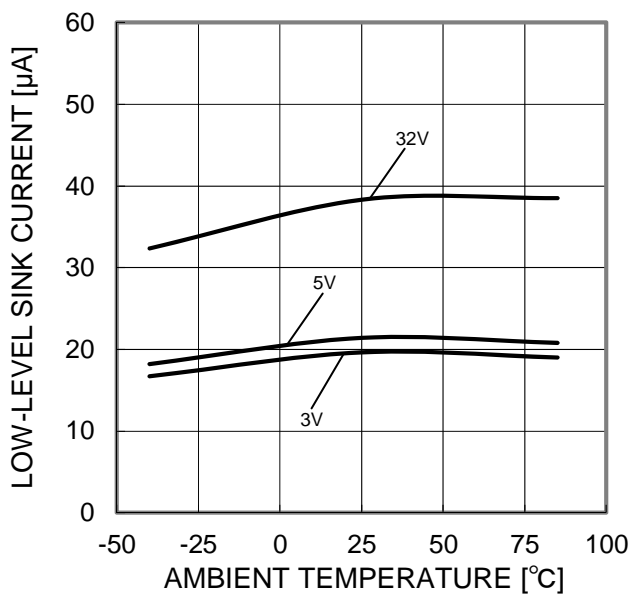

Figure 12.  
 Low Level Sink Current - Ambient Temperature  
 (OUT=0.2V)

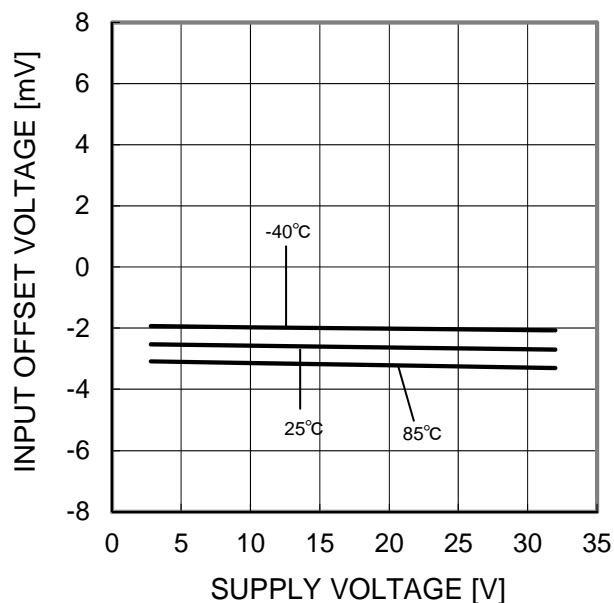

Figure 13.  
 Input Offset Voltage - Supply Voltage  
 (V<sub>ICM</sub>=0V, OUT=1.4V)

(\*) The above data is measurement value of typical sample, it is not guaranteed.

OBA10358

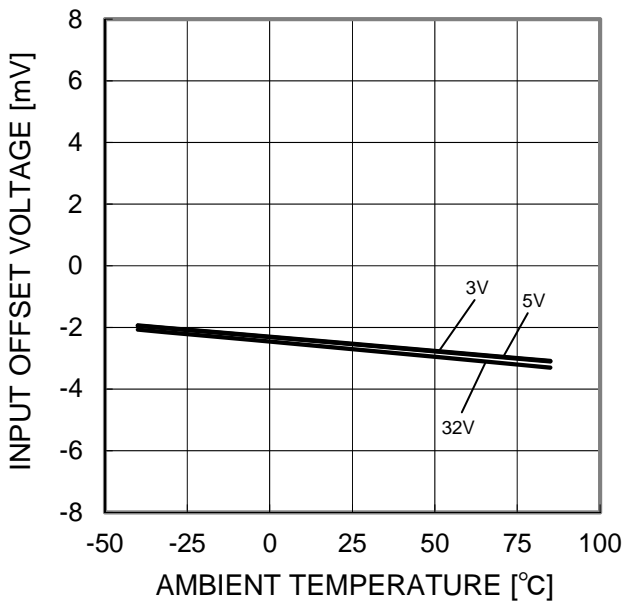

Figure 14.  
 Input Offset Voltage - Ambient Temperature  
 ( $V_{ICM}=0V$ ,  $OUT=1.4V$ )

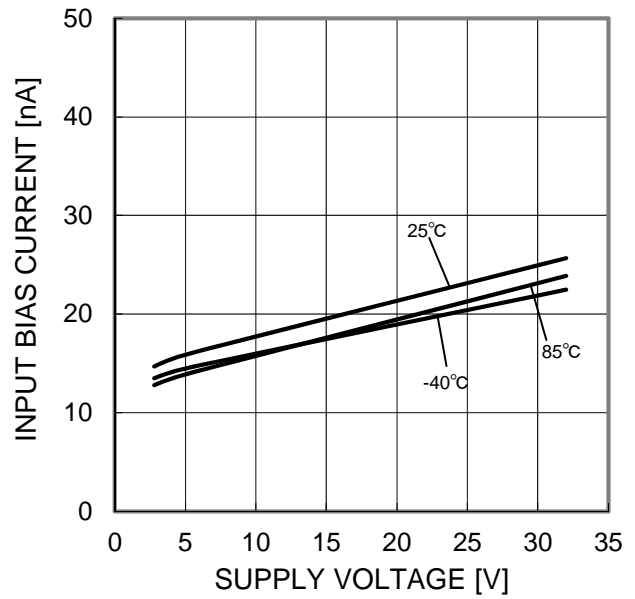

Figure 15.  
 Input Bias Current - Supply Voltage  
 ( $V_{ICM}=0V$ ,  $OUT=1.4V$ )

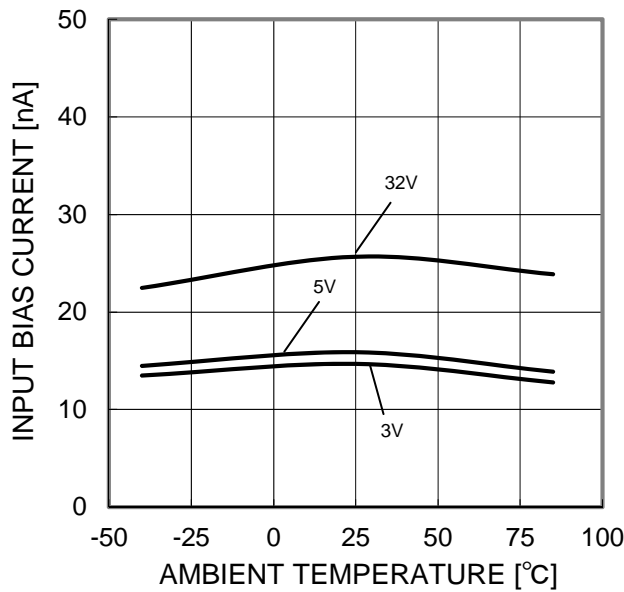

Figure 16.  
 Input Bias Current - Ambient Temperature  
 ( $V_{ICM}=0V$ ,  $OUT=1.4V$ )

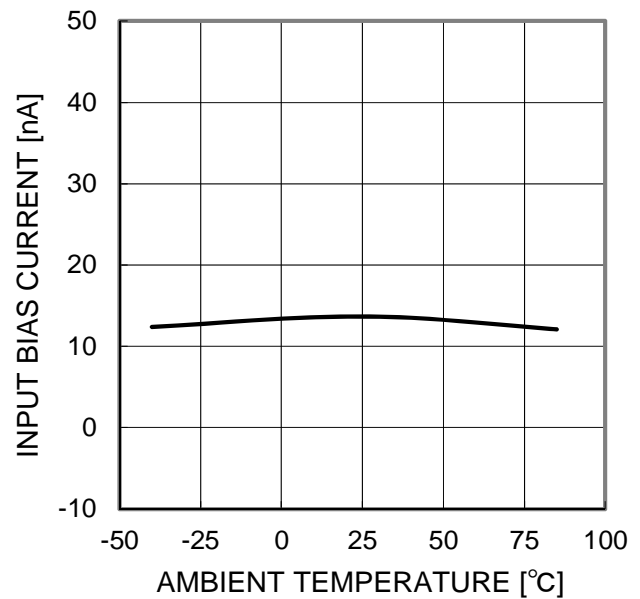

Figure 17.  
 Input Bias Current - Ambient Temperature  
 ( $VCC=30V$ ,  $V_{ICM}=28V$ ,  $OUT=1.4V$ )

(\*) The above data is measurement value of typical sample, it is not guaranteed.

OBA10358

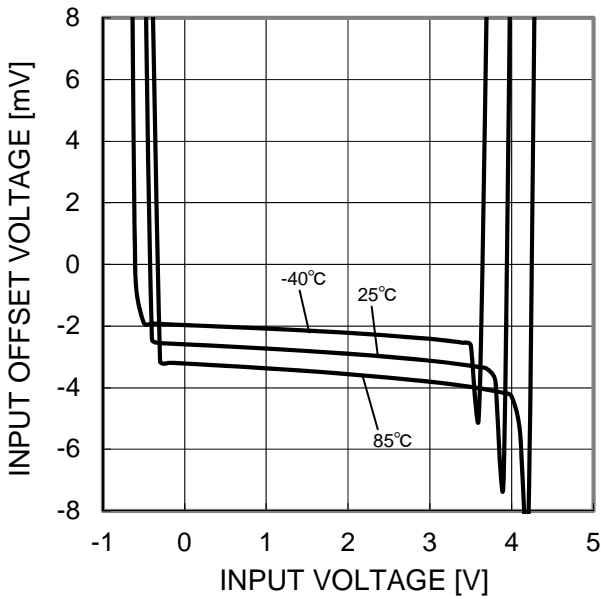

Figure 18.  
 Input Offset Voltage - Common Mode Input Voltage  
 (VCC=5V)

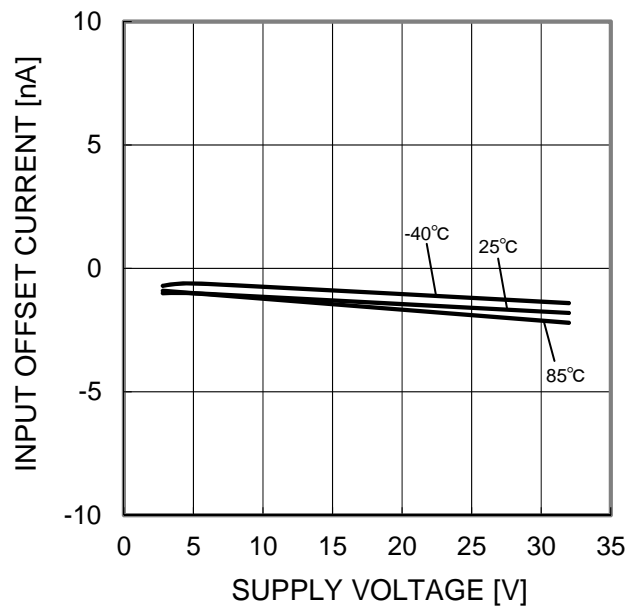

Figure 19.  
 Input Offset Current - Supply Voltage  
 (VICM=0V, OUT=1.4V)

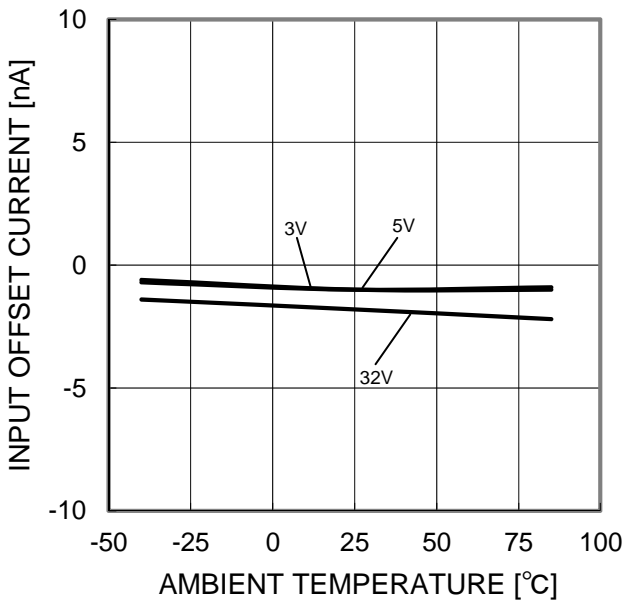

Figure 20.  
 Input Offset Current - Ambient Temperature  
 (VICM=0V, OUT=1.4V)

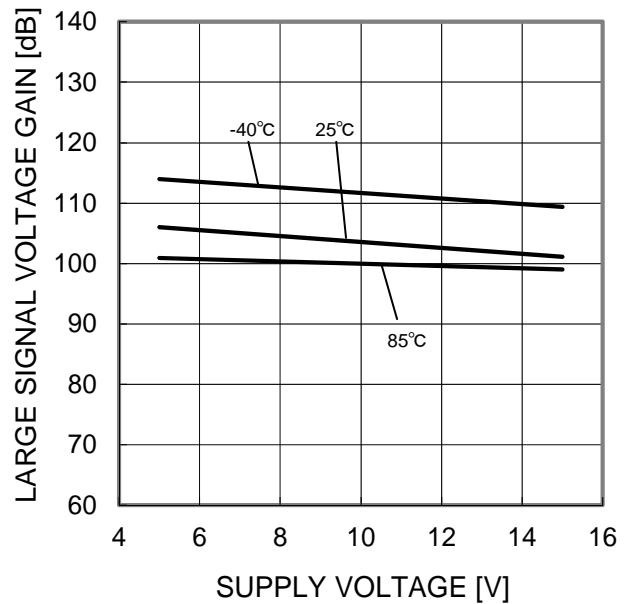

Figure 21.  
 Large Signal Voltage Gain - Supply Voltage  
 (RL=2kΩ)

(\*) The above data is measurement value of typical sample, it is not guaranteed.

OBA10358

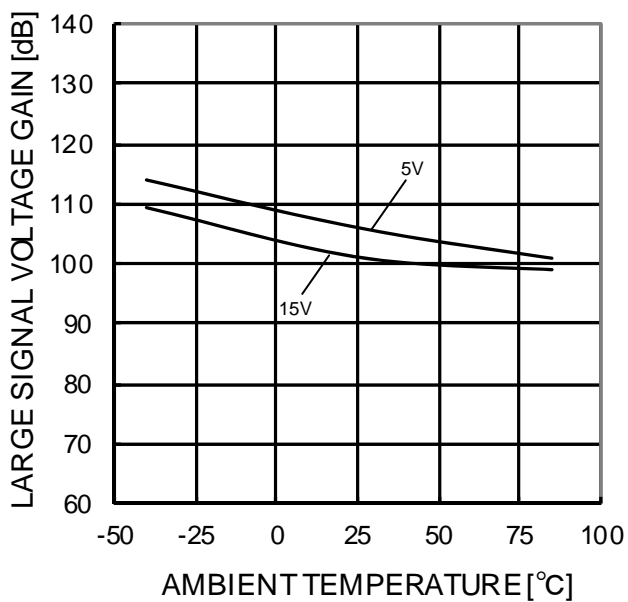

Figure 22.  
 Large Signal Voltage Gain - Ambient Temperature  
 (RL=2kΩ)

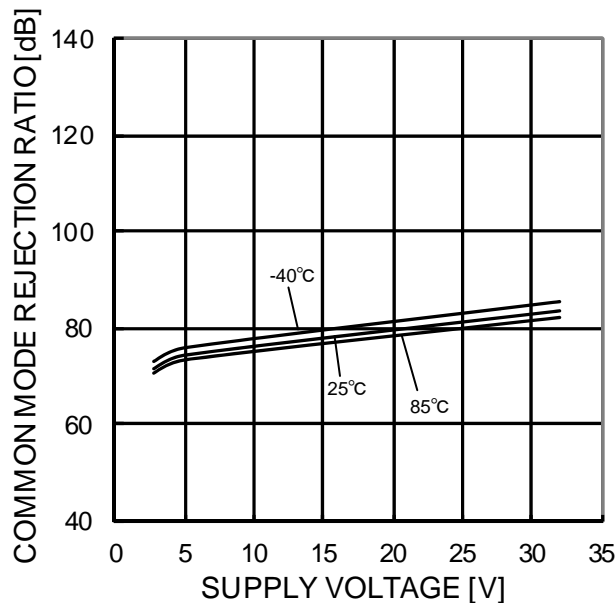

Figure 23.  
 Common Mode Rejection Ratio  
 - Supply Voltage

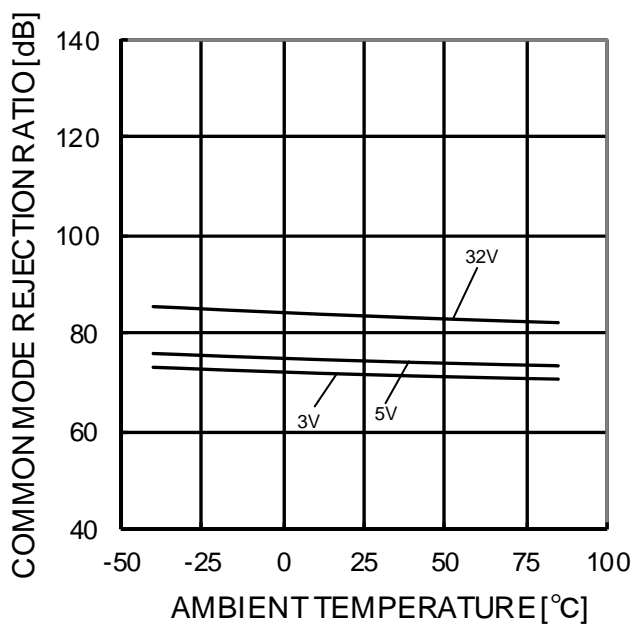

Figure 24.  
 Common Mode Rejection Ratio  
 - Ambient Temperature

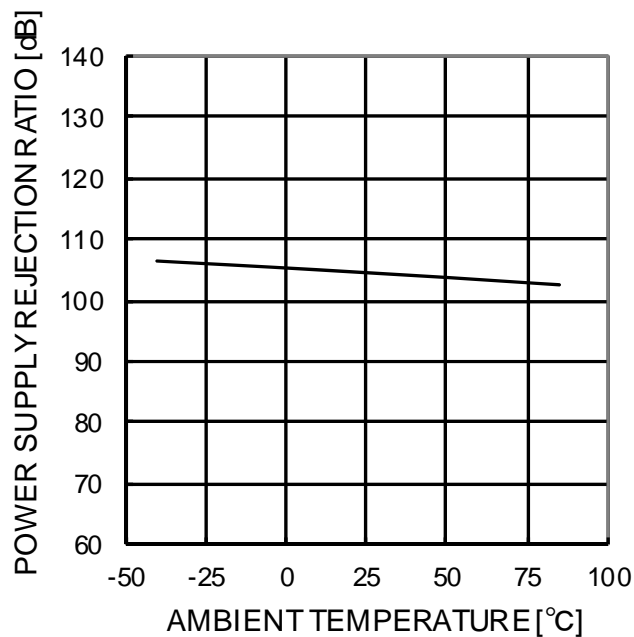

Figure 25.  
 Power Supply Rejection Ratio  
 - Ambient Temperature

(\*) The above data is measurement value of typical sample, it is not guaranteed.

OBA10324A

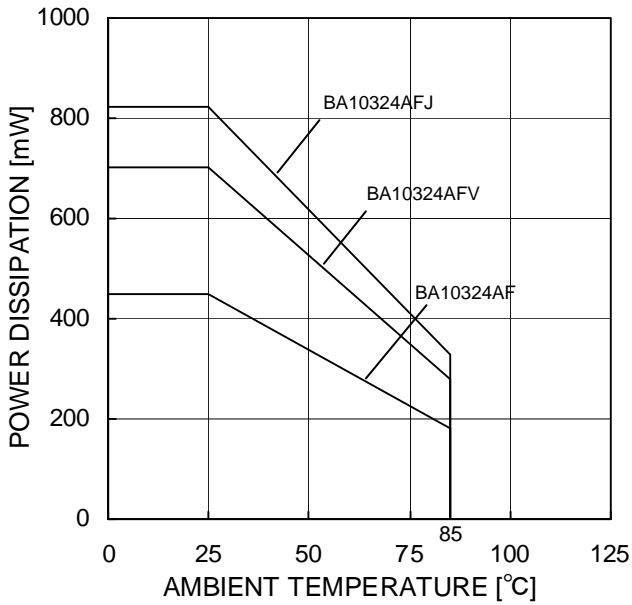

Figure 26.  
 Derating Curve

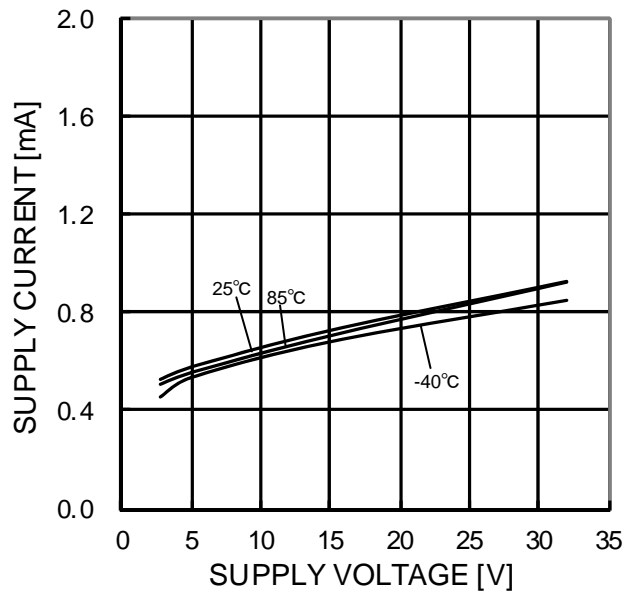

Figure 27.  
 Supply Current - Supply Voltage

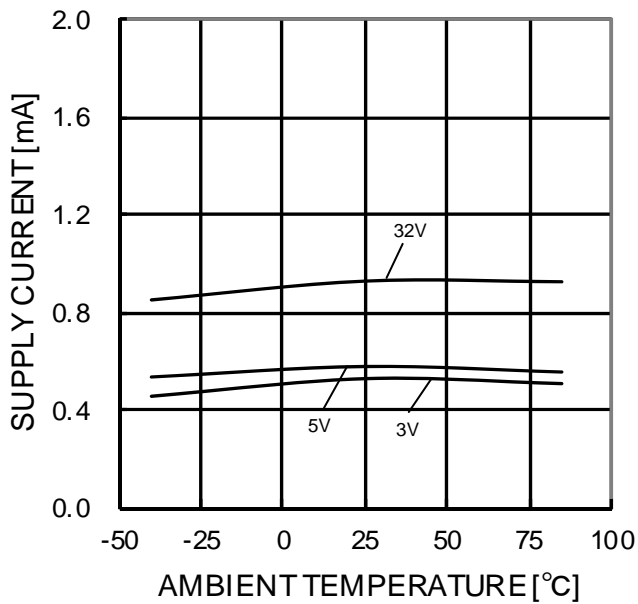

Figure 28.  
 Supply Current - Ambient Temperature

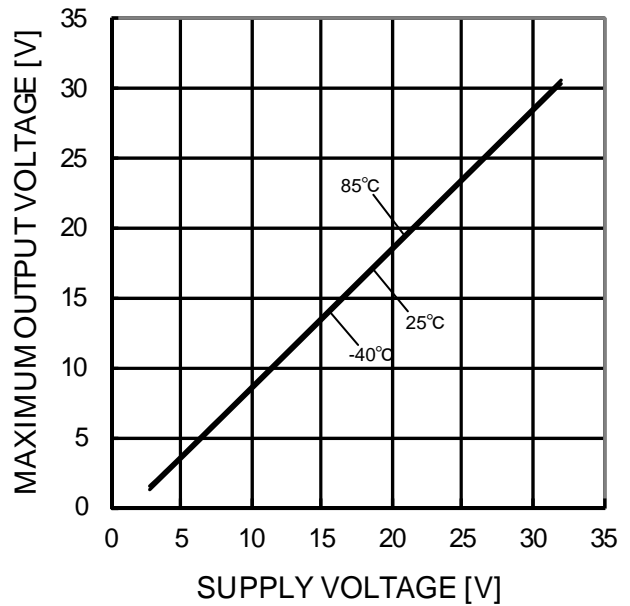

Figure 29.  
 Maximum Output Voltage - Supply Voltage  
 (RL=10kΩ)

(\*) The above data is measurement value of typical sample, it is not guaranteed.

OBA10324A

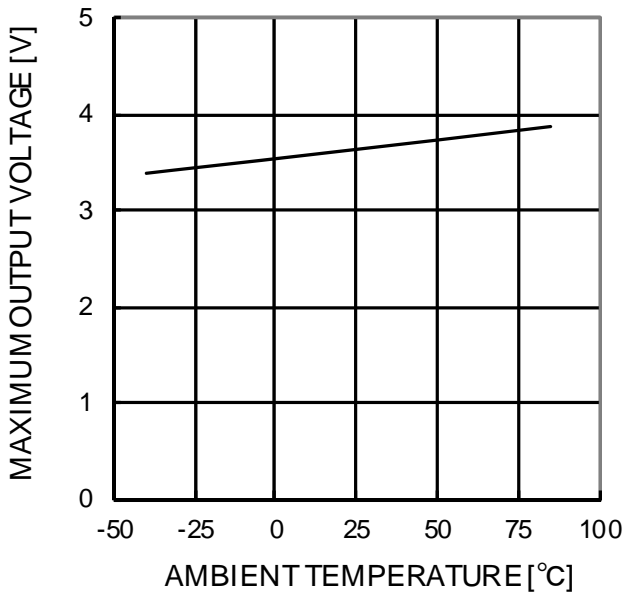

Figure 30.  
 Maximum Output Voltage - Ambient Temperature  
 (VCC=5V, RL=2kΩ)

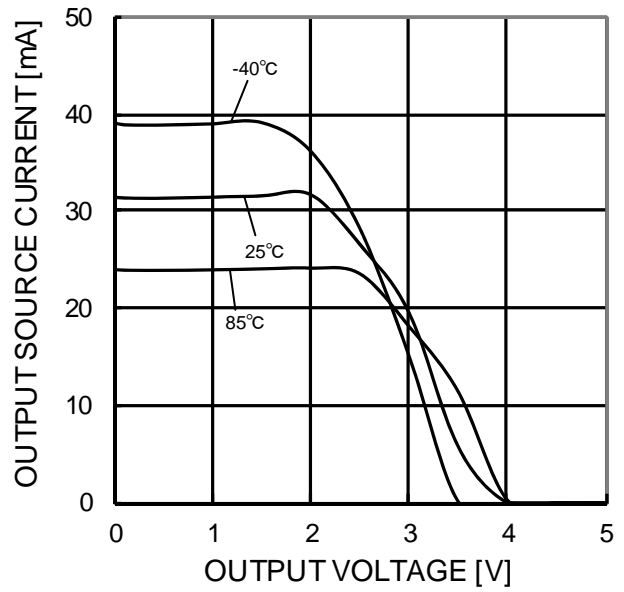

Figure 31.  
 Output Source Current - Output Voltage  
 (VCC=5V)

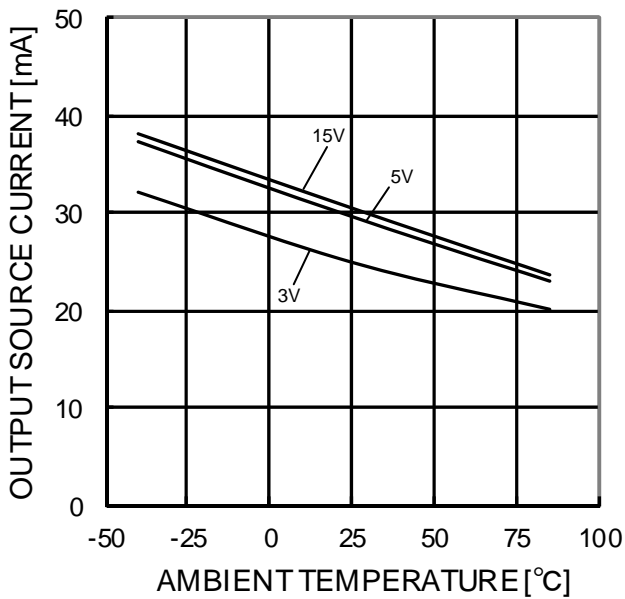

Figure 32.  
 Output Source Current - Ambient Temperature  
 (OUT=0V)

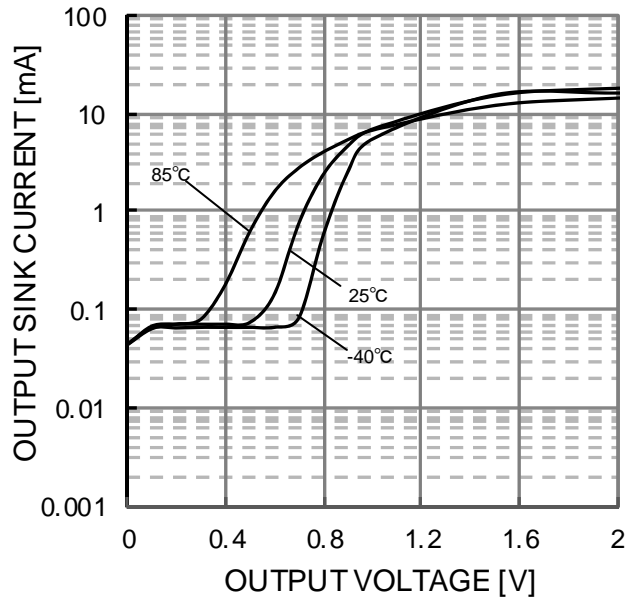

Figure 33.  
 Output Sink Current - Output Voltage  
 (VCC=5V)

(\*) The above data is measurement value of typical sample, it is not guaranteed.

OBA10324A

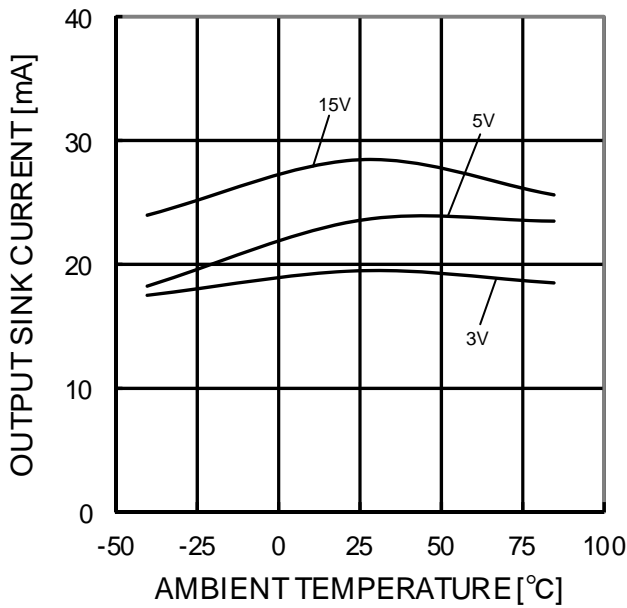

Figure 34.  
 Output Sink Current - Ambient Temperature  
 (OUT=VCC)

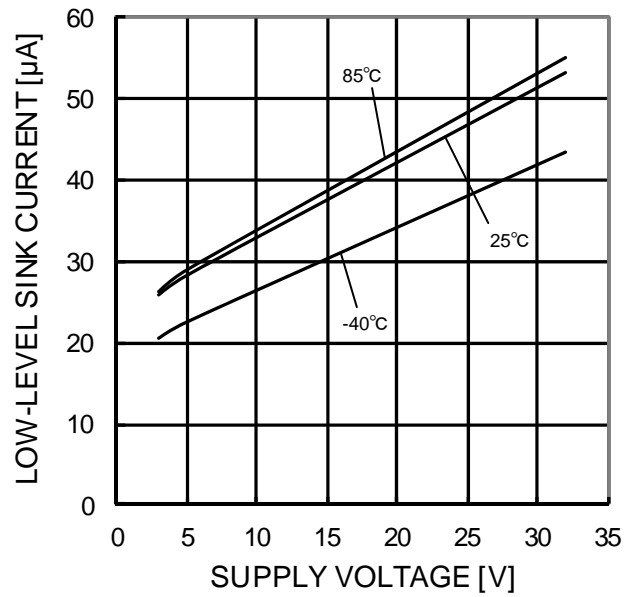

Figure 35.  
 Low Level Sink Current - Supply Voltage  
 (OUT=0.2V)

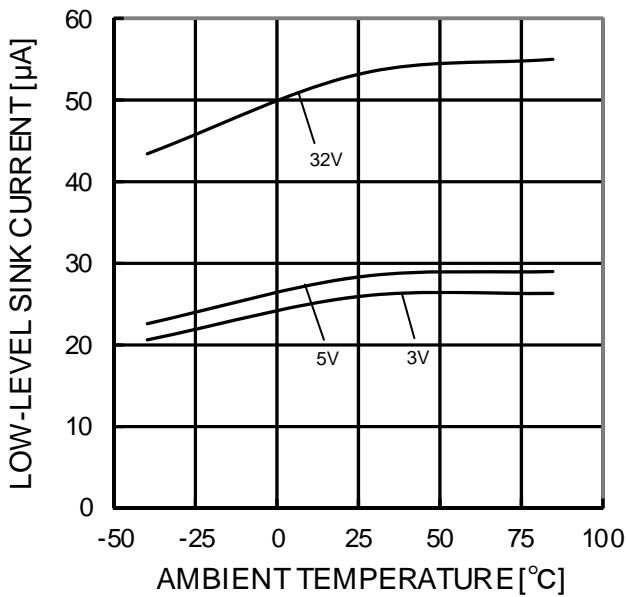

Figure 36.  
 Low Level Sink Current - Ambient Temperature  
 (OUT=0.2V)

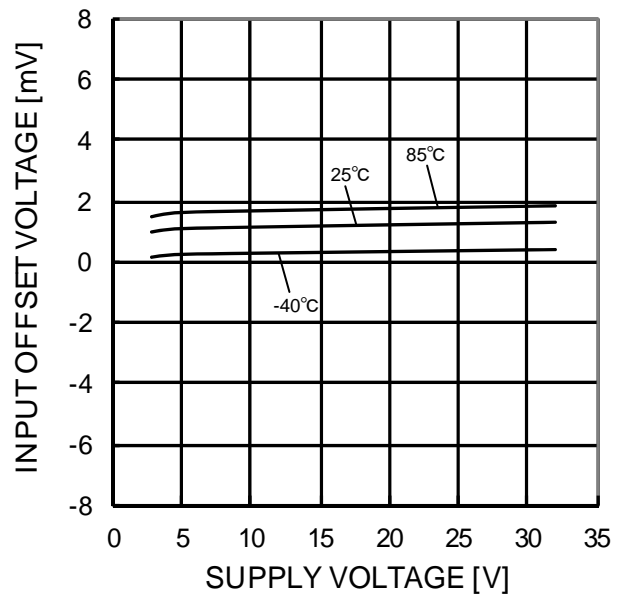

Figure 37.  
 Input Offset Voltage - Supply Voltage  
 ( $V_{ICM}=0V$ , OUT=1.4V)

(\*) The above data is measurement value of typical sample, it is not guaranteed.

OBA10324A

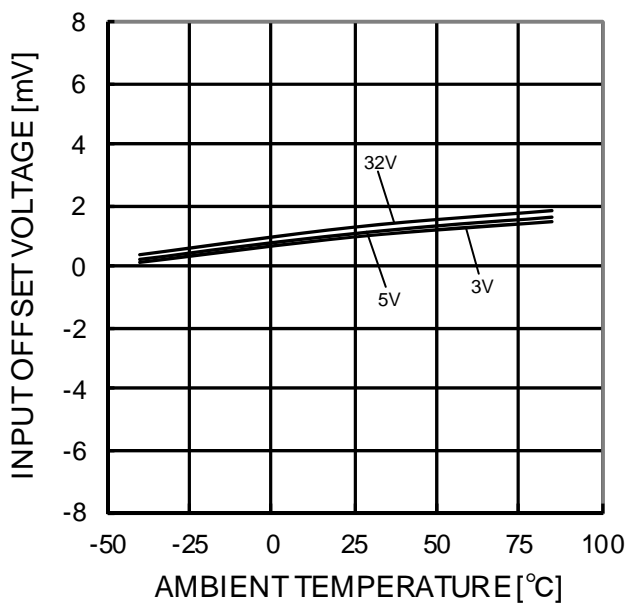

Figure 38.  
 Input Offset Voltage - Ambient Temperature  
 ( $V_{ICM}=0V$ ,  $OUT=1.4V$ )

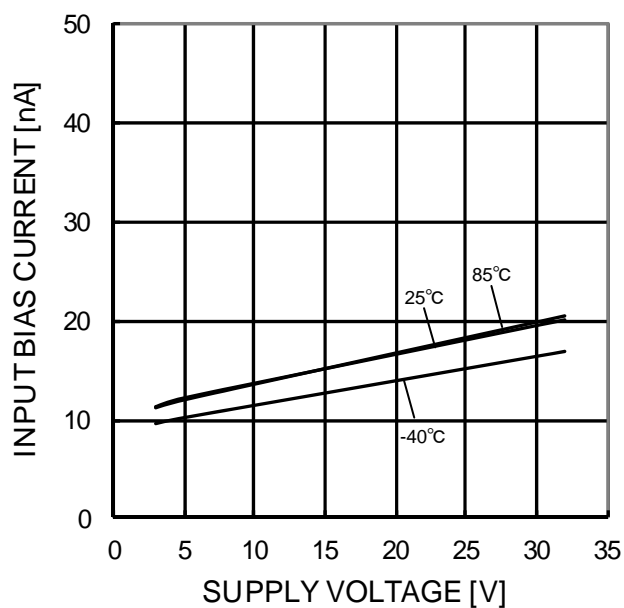

Figure 39.  
 Input Bias Current - Supply Voltage  
 ( $V_{ICM}=0V$ ,  $OUT=1.4V$ )

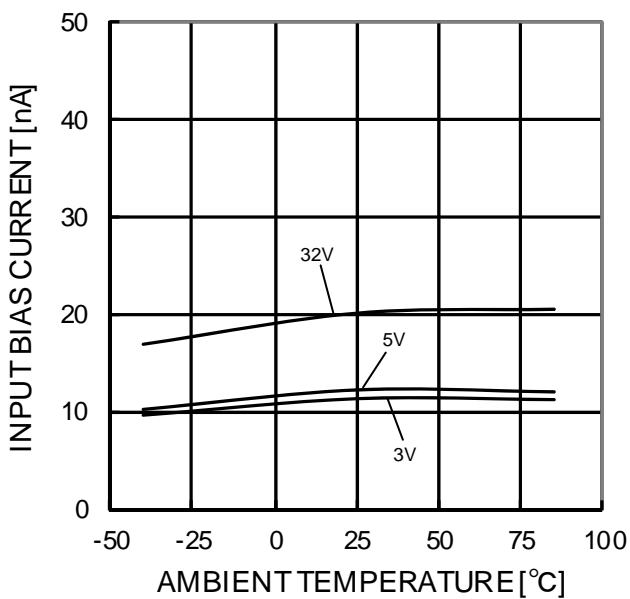

Figure 40.  
 Input Bias Current - Ambient Temperature  
 ( $V_{ICM}=0V$ ,  $OUT=1.4V$ )

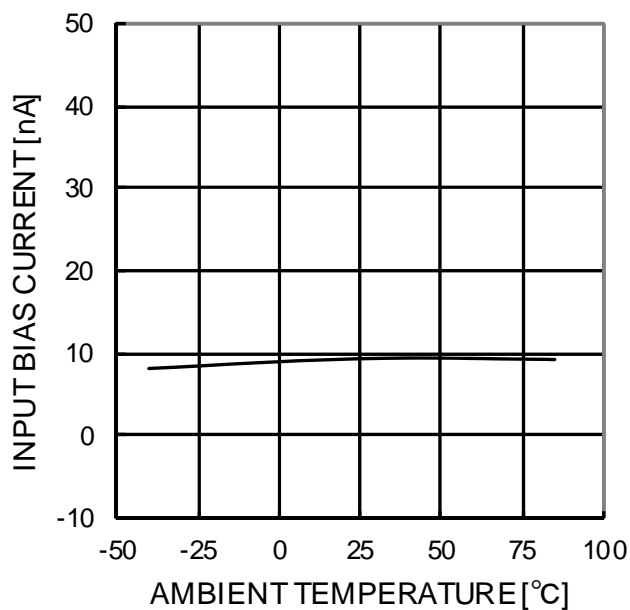

Figure 41.  
 Input Bias Current - Ambient Temperature  
 ( $V_{CC}=30V$ ,  $V_{ICM}=28V$ ,  $OUT=1.4V$ )

(\*) The above data is measurement value of typical sample, it is not guaranteed.

OBA10324A

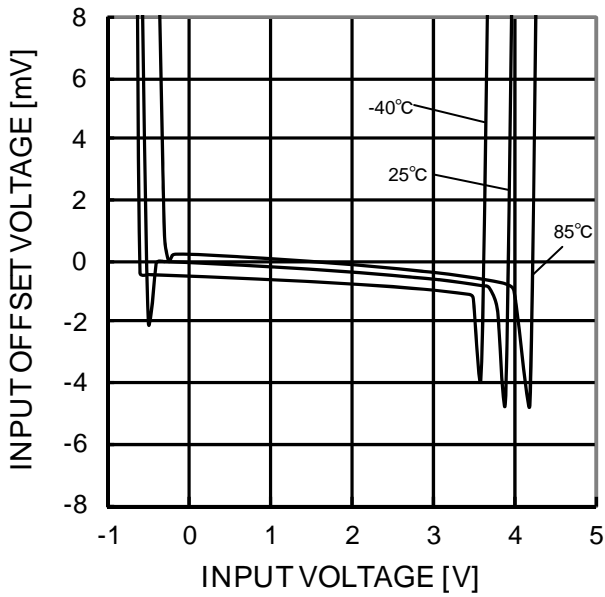

Figure 42.  
 Input Offset Voltage  
 - Common Mode Input Voltage  
 (VCC=5V)

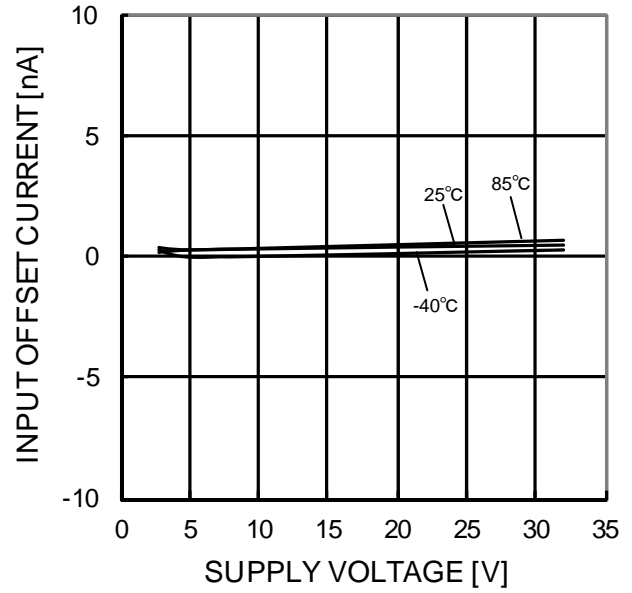

Figure 43.  
 Input Offset Current - Supply Voltage  
 (V<sub>ICM</sub>=0V, OUT=1.4V)

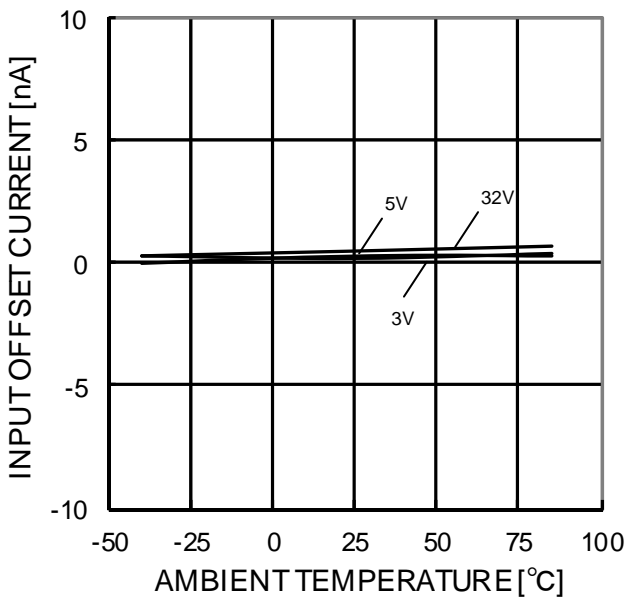

Figure 44.  
 Input Offset Current - Ambient Temperature  
 (V<sub>ICM</sub>=0V, OUT=1.4V)

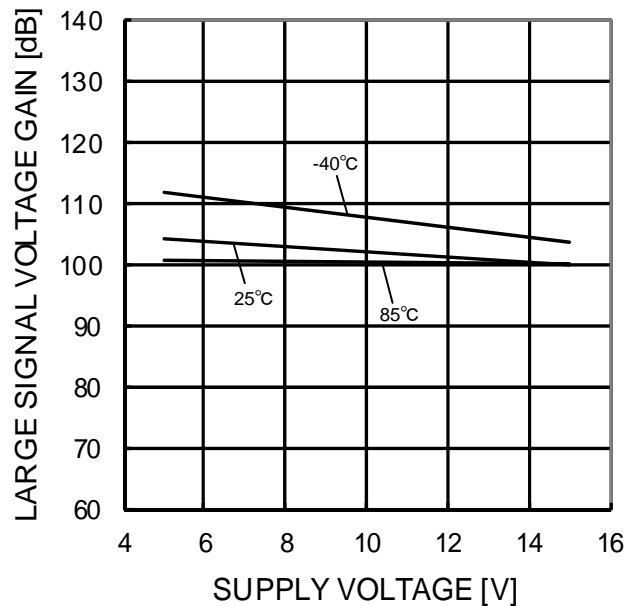

Figure 45.  
 Large Signal Voltage Gain - Supply Voltage  
 (R<sub>L</sub>=2kΩ)

(\*) The above data is measurement value of typical sample, it is not guaranteed.

OBA10324A

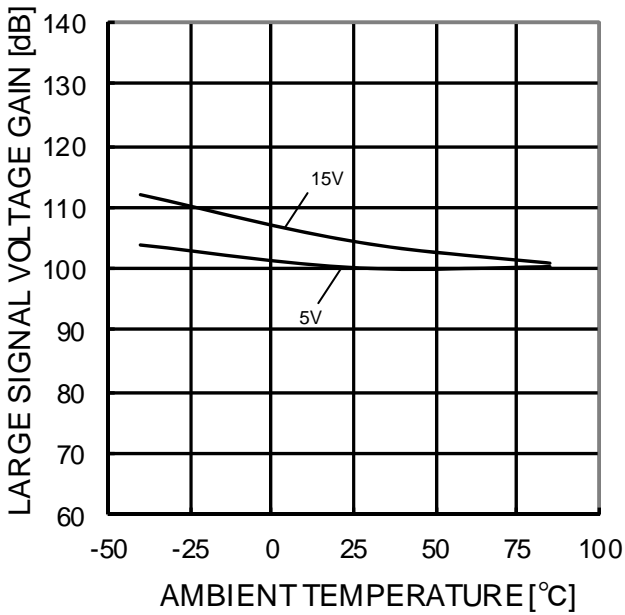

Figure 46.  
 Large Signal Voltage Gain  
 - Ambient Temperature  
 (RL=2kΩ)

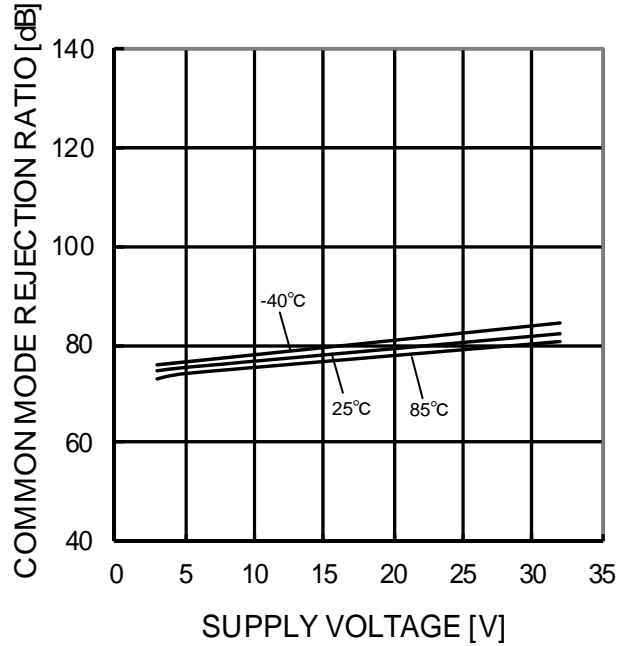

Figure 47.  
 Common Mode Rejection Ratio  
 - Supply Voltage

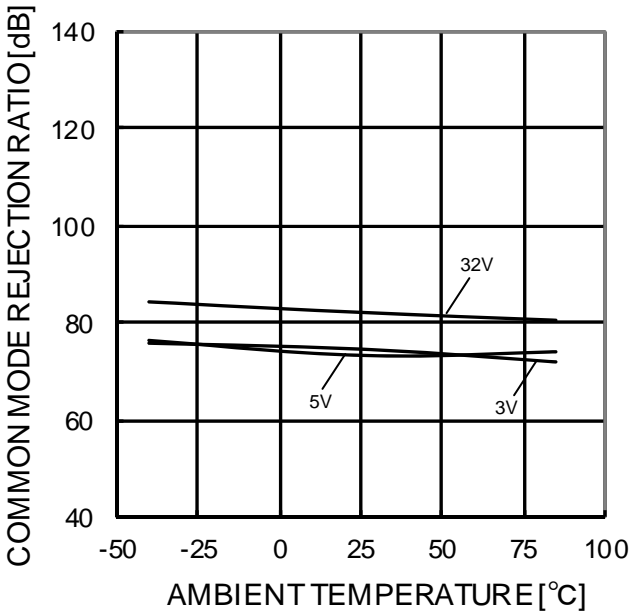

Figure 48.  
 Common Mode Rejection Ratio  
 - Ambient Temperature

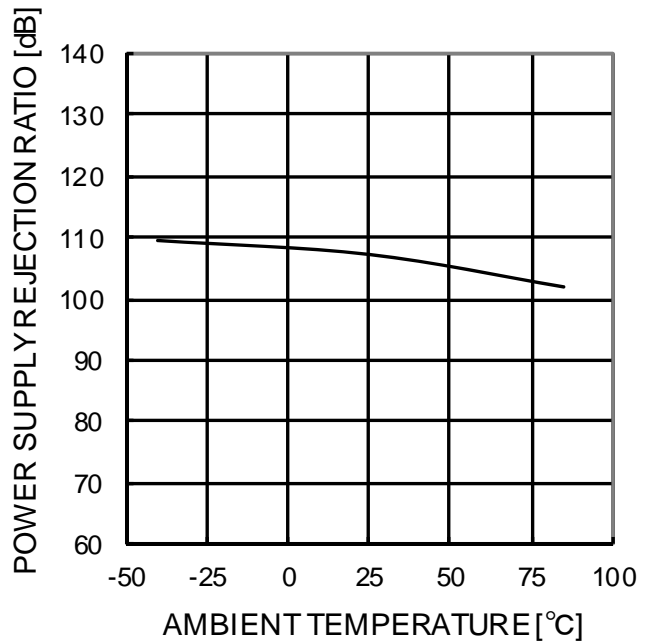

Figure 49.  
 Power Supply Rejection Ratio  
 - Ambient Temperature

(\*) The above data is measurement value of typical sample, it is not guaranteed.

OBA2904, BA2904S, BA2904W

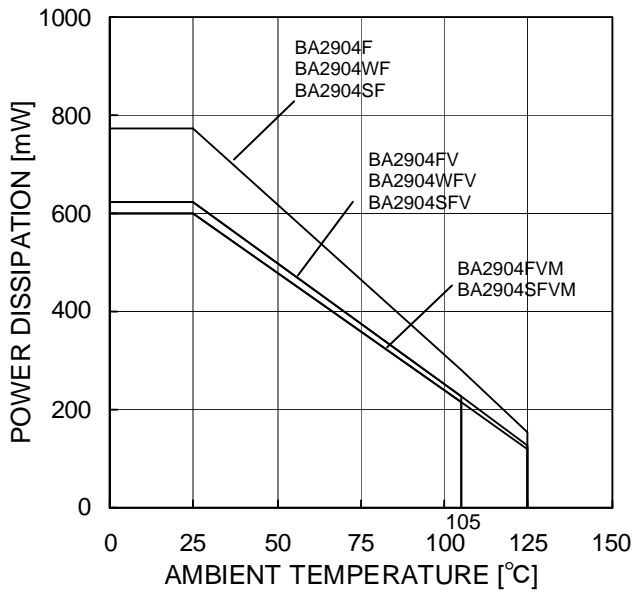

Figure 50.  
Derating Curve

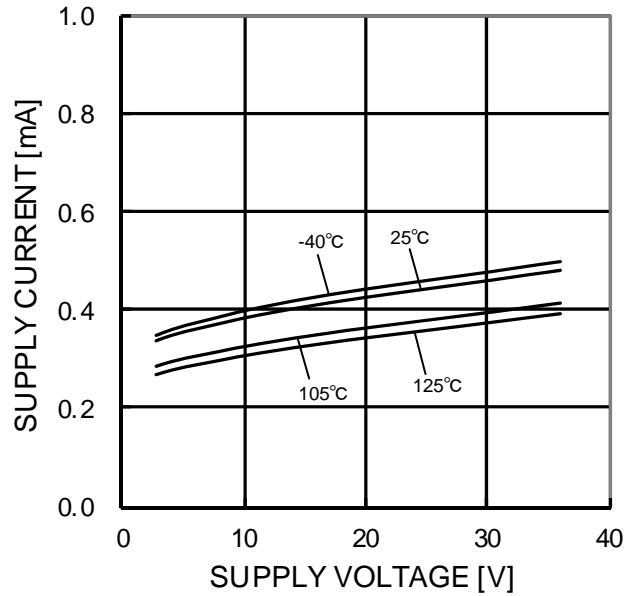

Figure 51.  
Supply Current- Supply Voltage

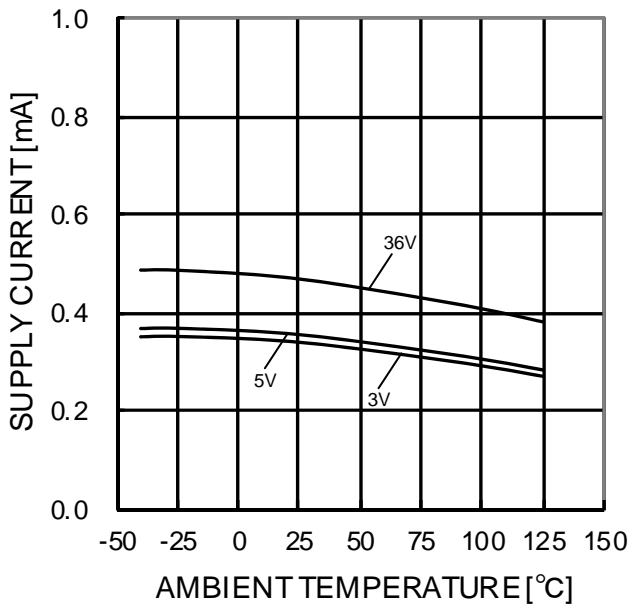

Figure 52.  
Supply Current - Ambient Temperature

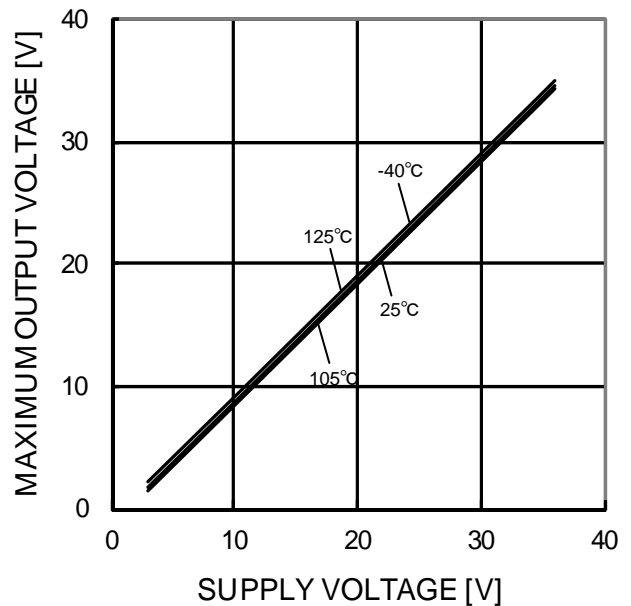

Figure 53.  
Maximum Output Voltage - Supply Voltage  
(RL=10kΩ)

(\*) The above data is measurement value of typical sample, it is not guaranteed.

BA2904, BA2904W : -40°C to +125°C BA2904S : -40°C to +105°C

OBA2904, BA2904S, BA2904W

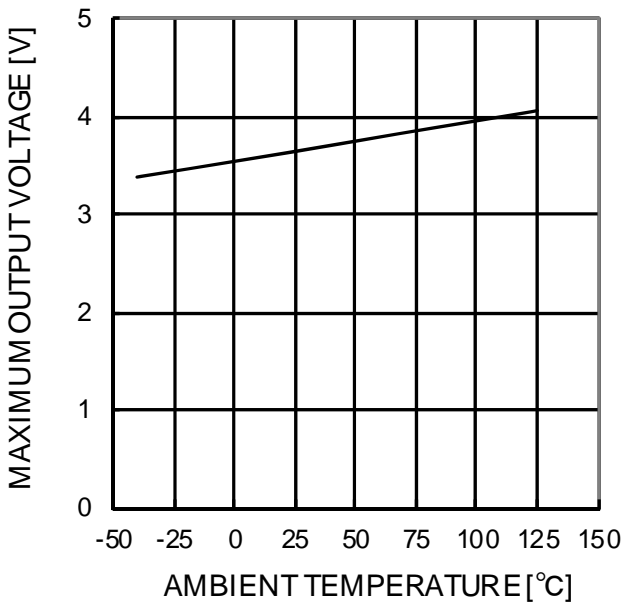

Figure 54.  
 Maximum Output Voltage - Ambient Temperature  
 (VCC=5V, RL=2kΩ)

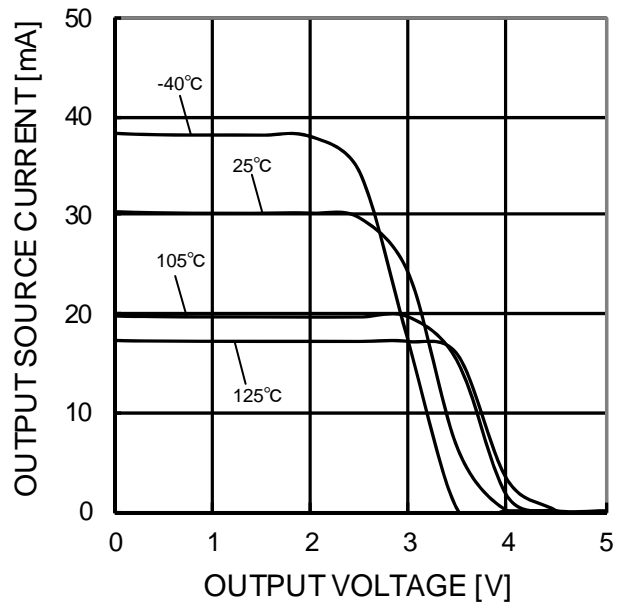

Figure 55.  
 Output Source Current - Output Voltage  
 (VCC=5V)

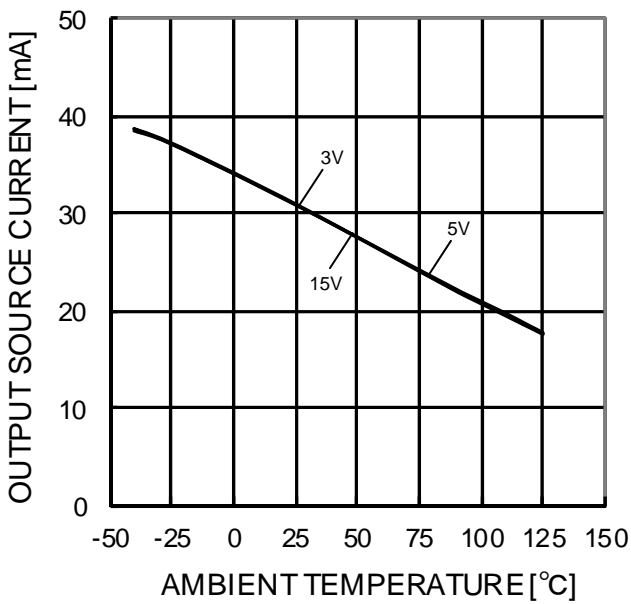

Figure 56.  
 Output Source Current - Ambient Temperature  
 (OUT=0V)

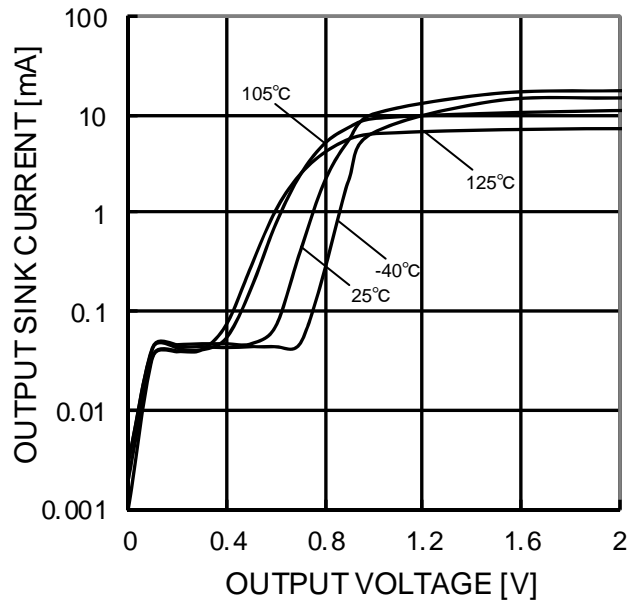

Figure 57.  
 Output Sink Current - Output Voltage  
 (VCC=5V)

(\*) The above data is measurement value of typical sample, it is not guaranteed.

OBA2904, BA2904S, BA2904W

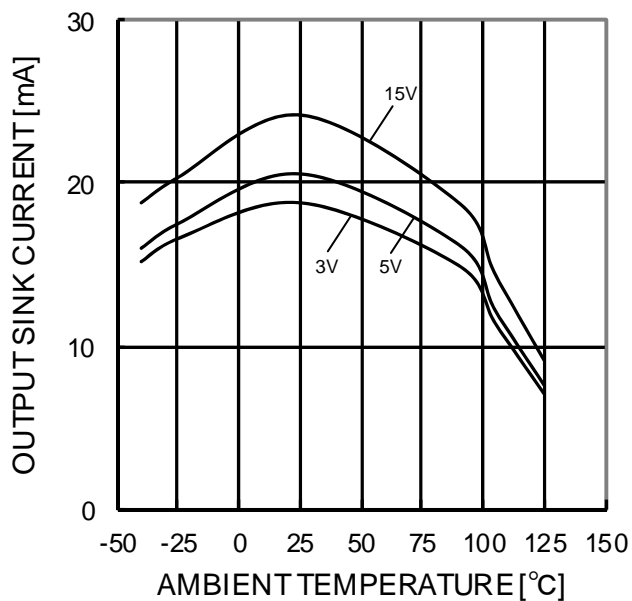

Figure 58.  
 Output Sink Current - Ambient Temperature  
 (OUT=VCC)

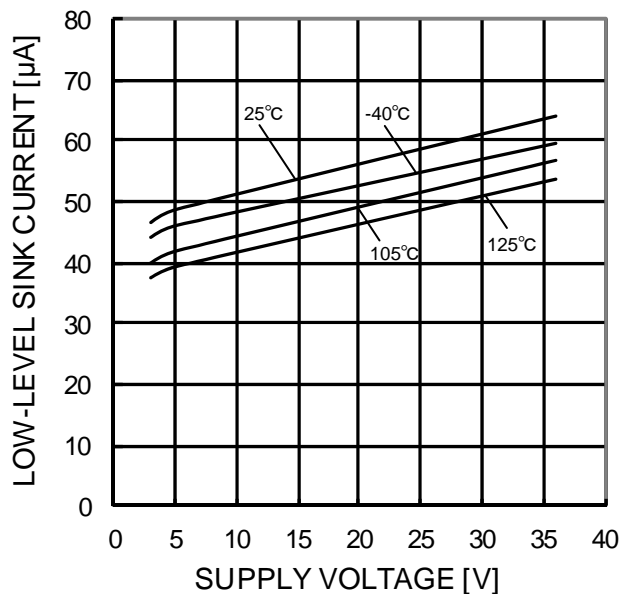

Figure 59.  
 Low Level Sink Current - Supply Voltage  
 (OUT=0.2V)

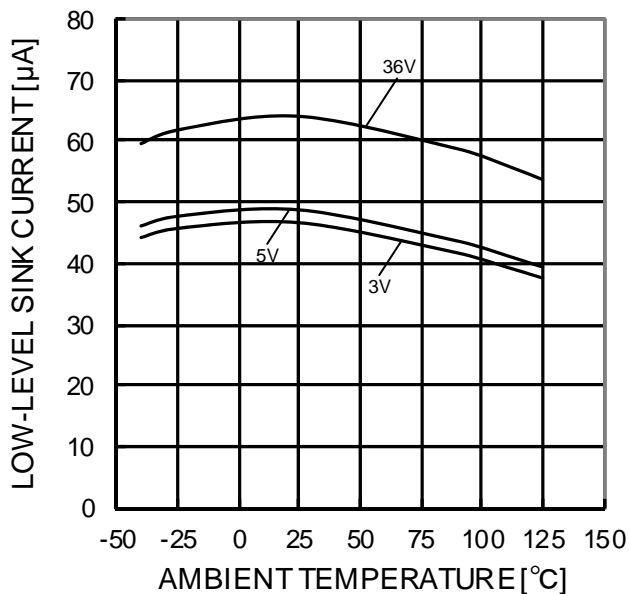

Figure 60.  
 Low Level Sink Current - Ambient Temperature  
 (OUT=0.2V)

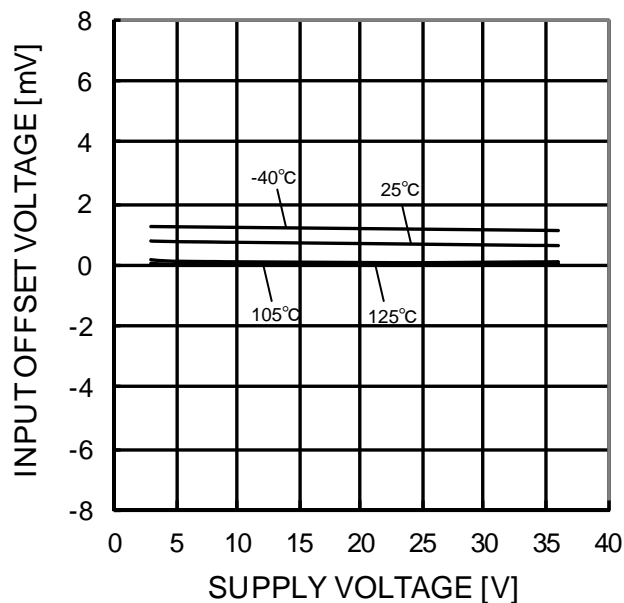

Figure 61.  
 Input Offset Voltage - Supply Voltage  
 (V<sub>ICM</sub>=0V, OUT=1.4V)

(\*) The above data is measurement value of typical sample, it is not guaranteed.

OBA2904, BA2904S, BA2904W

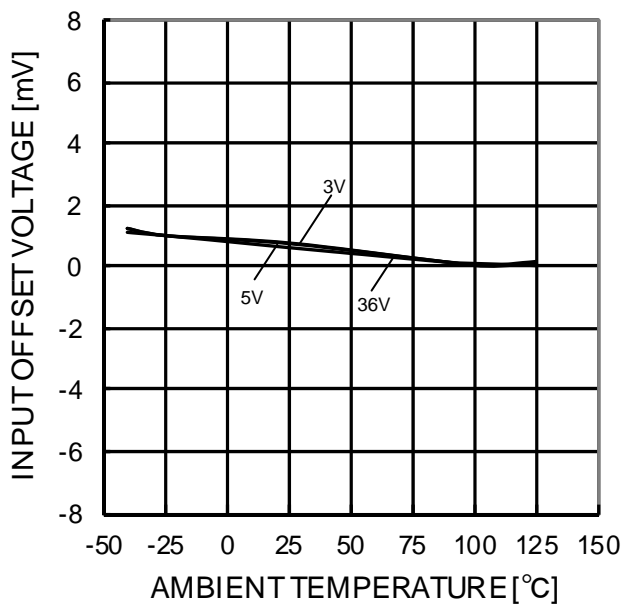

Figure 62.  
 Input Offset Voltage - Ambient Temperature  
 ( $V_{ICM}=0V$ ,  $OUT=1.4V$ )

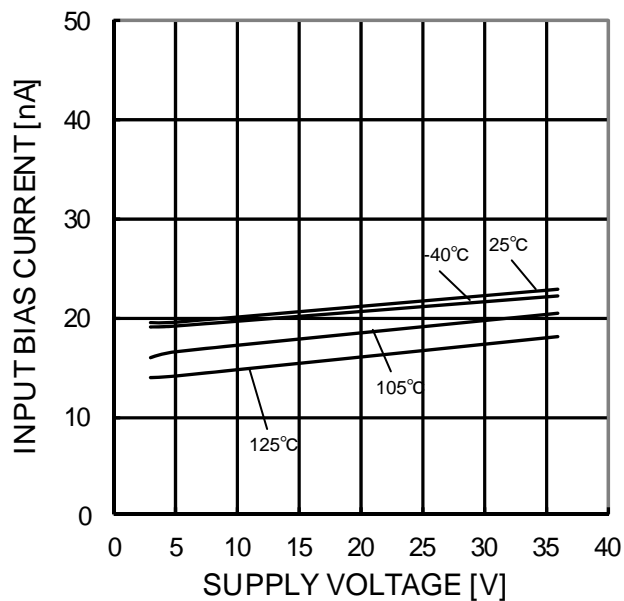

Figure 63.  
 Input Bias Current - Supply Voltage  
 ( $V_{ICM}=0V$ ,  $OUT=1.4V$ )

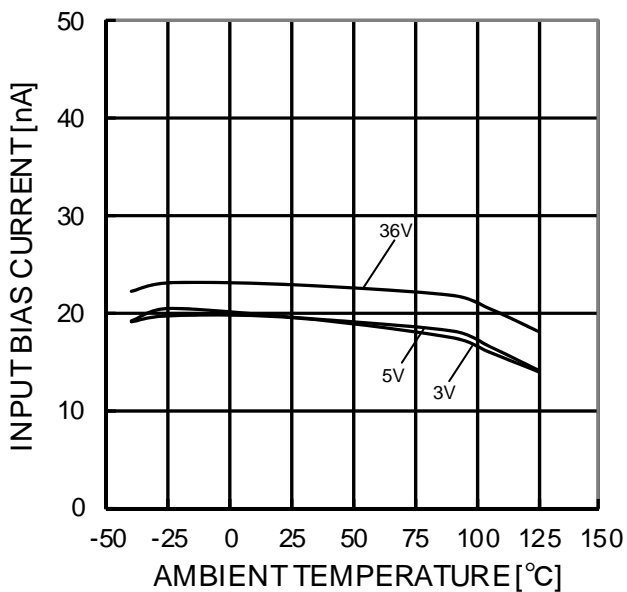

Figure 64.  
 Input Bias Current - Ambient Temperature  
 ( $V_{ICM}=0V$ ,  $OUT=1.4V$ )

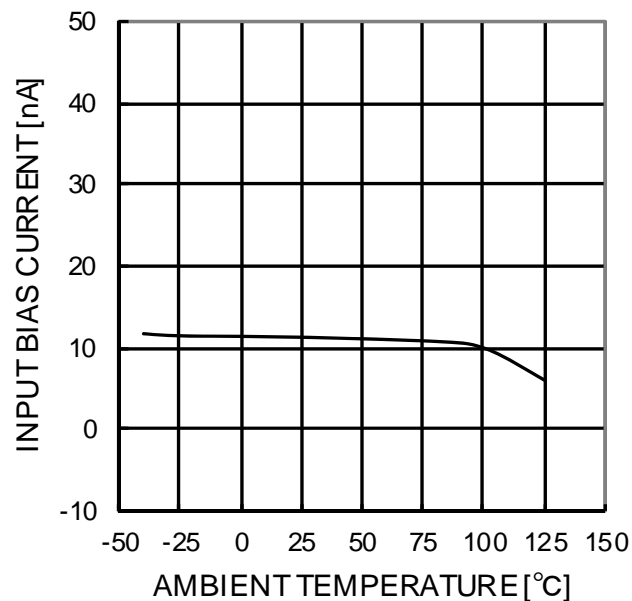

Figure 65.  
 Input Bias Current - Ambient Temperature  
 ( $VCC=30V$ ,  $V_{ICM}=28V$ ,  $OUT=1.4V$ )

(\*) The above data is measurement value of typical sample, it is not guaranteed.

OBA2904, BA2904S, BA2904W

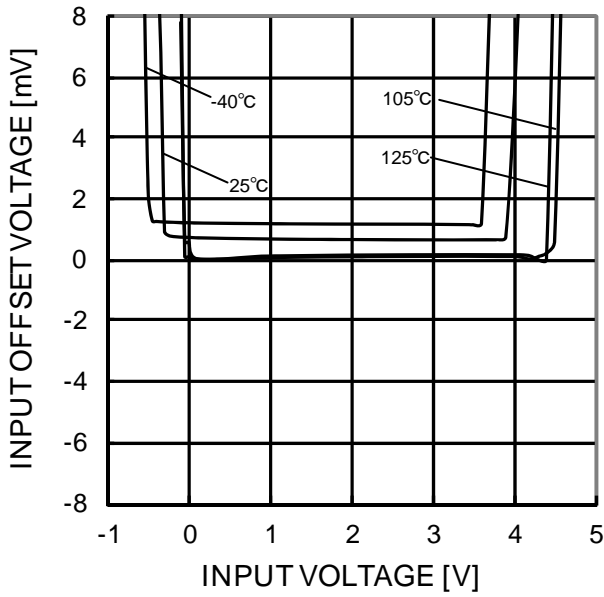

Figure 66.  
 Input Offset Voltage - Common Mode Input Voltage  
 ( $V_{CC}=5V$ )

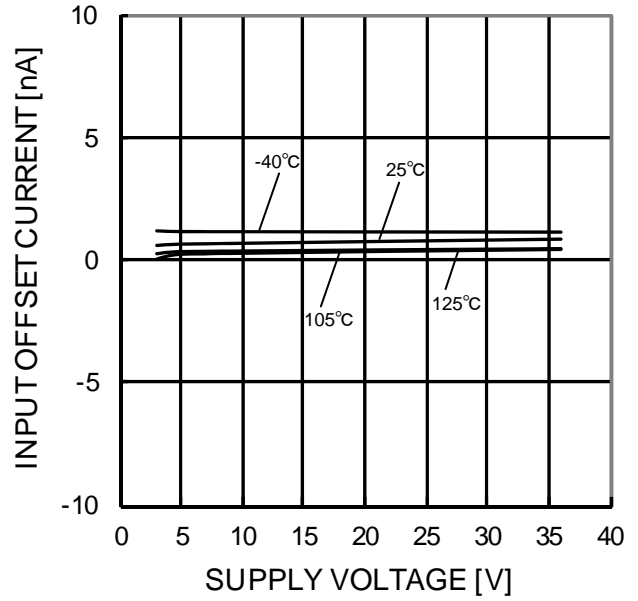

Figure 67.  
 Input Offset Current - Supply Voltage  
 ( $V_{ICM}=0V$ ,  $OUT=1.4V$ )

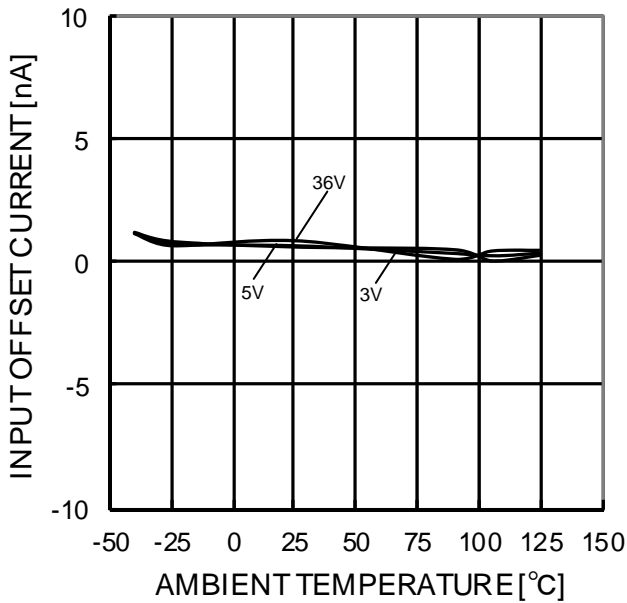

Figure 68.  
 Input Offset Current - Ambient Temperature  
 ( $V_{ICM}=0V$ ,  $OUT=1.4V$ )

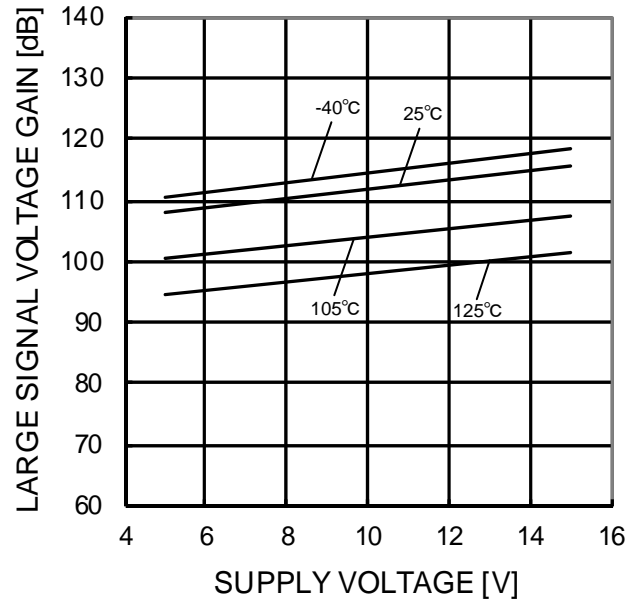

Figure 69.  
 Large Signal Voltage Gain - Supply Voltage  
 ( $R_L=2k\Omega$ )

(\*) The above data is measurement value of typical sample, it is not guaranteed.

OBA2904, BA2904S, BA2904W

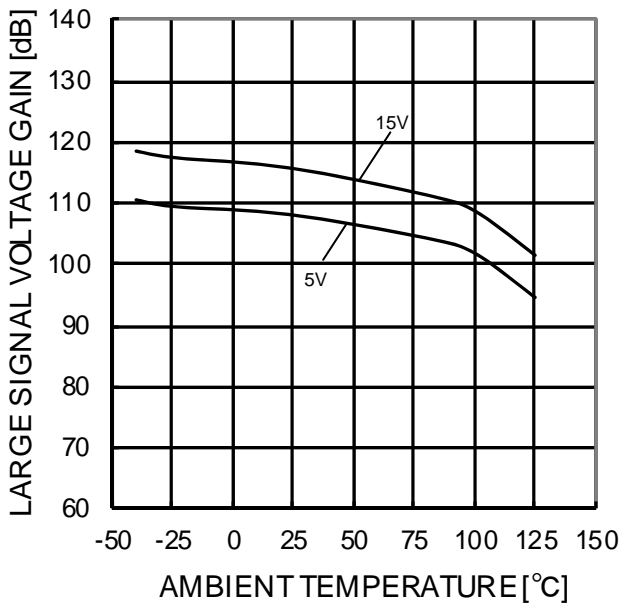

Figure 70.  
 Large Signal Voltage Gain  
 - Ambient Temperature  
 (RL=2kΩ)

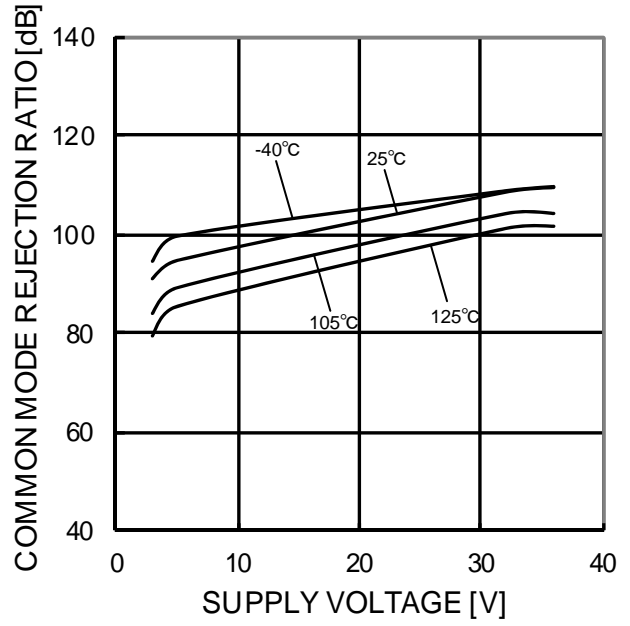

Figure 71.  
 Common Mode Rejection Ratio  
 - Supply Voltage

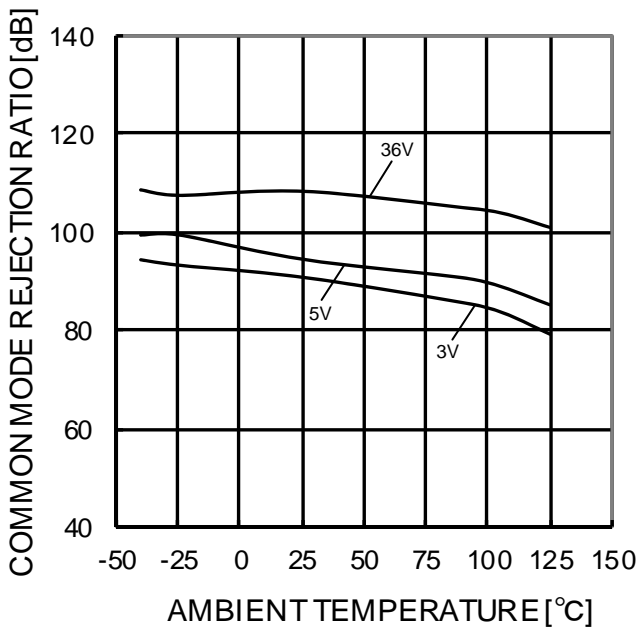

Figure 72.  
 Common Mode Rejection Ratio  
 - Ambient Temperature

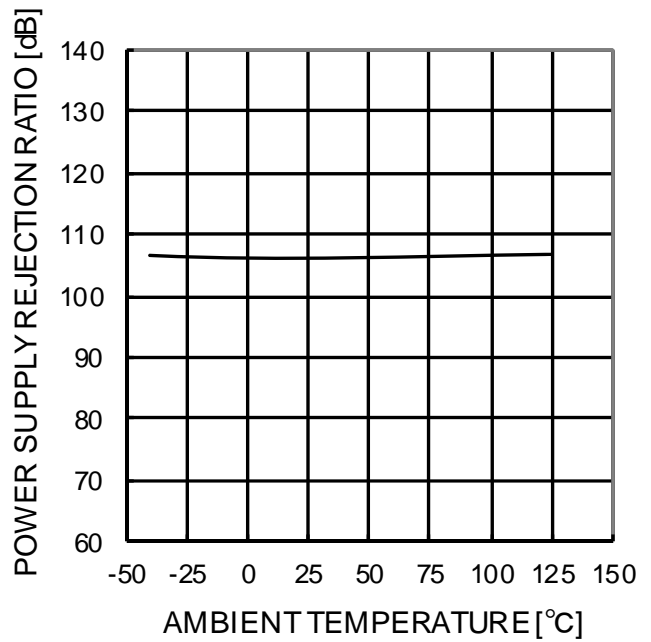

Figure 73.  
 Power Supply Rejection Ratio  
 - Ambient Temperature

(\*) The above data is measurement value of typical sample, it is not guaranteed.

OBA2902, BA2902S

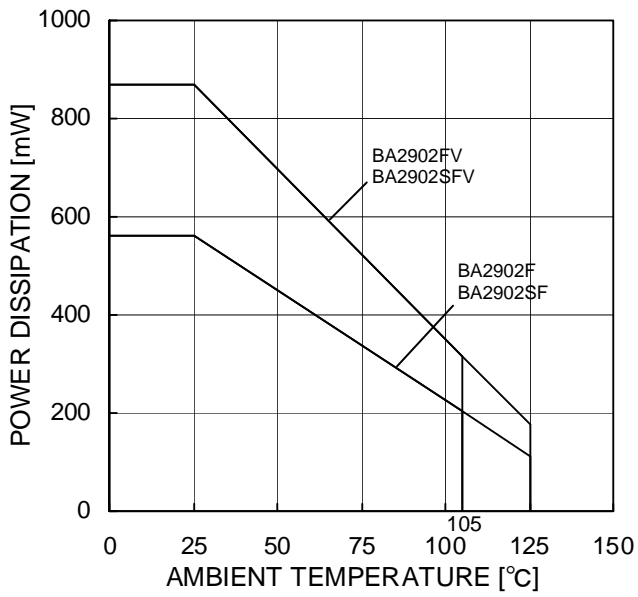

Figure 74.  
 Derating Curve

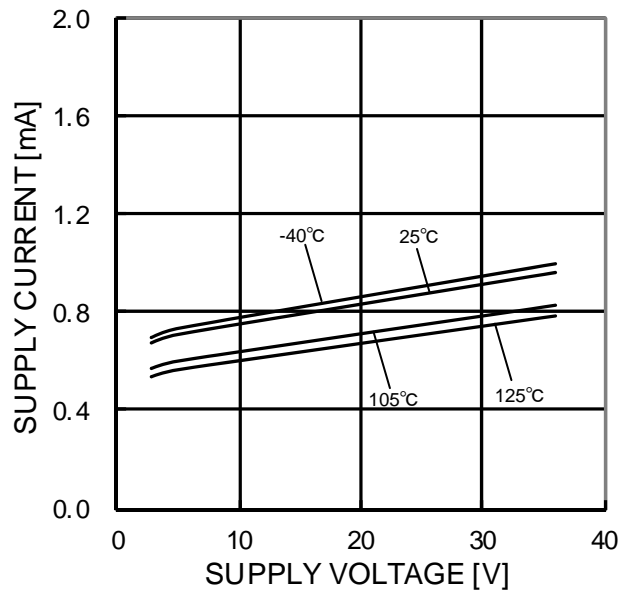

Figure 75.  
 Supply Current - Supply Voltage

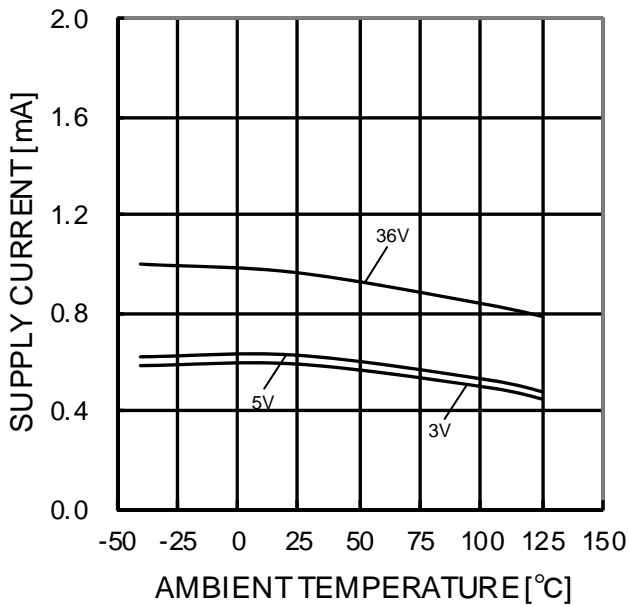

Figure 76.  
 Supply Current - Ambient Temperature

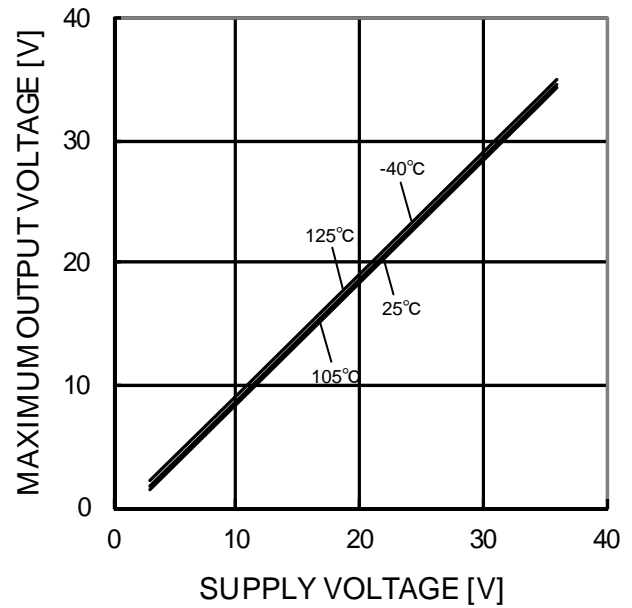

Figure 77.  
 Maximum Output Voltage - Supply Voltage  
 (RL=10kΩ)

(\*) The above data is measurement value of typical sample, it is not guaranteed.  
 BA2902 : -40°C to +125°C BA2902S : -40°C to +105°C

OBA2902, BA2902S

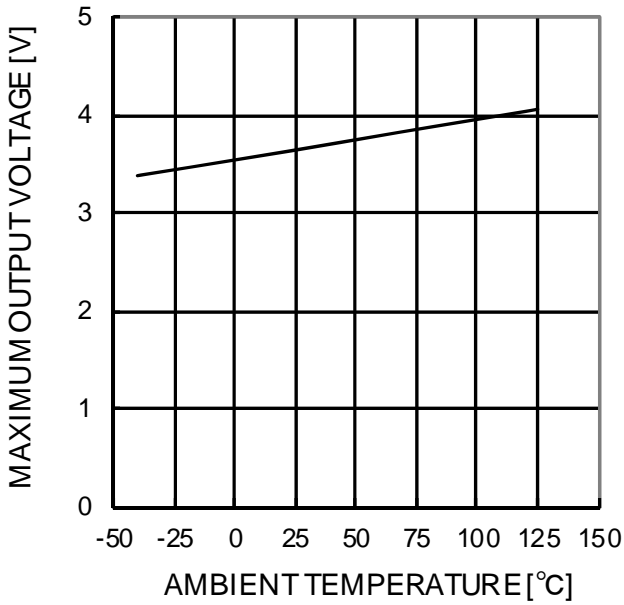

Figure 78.  
 Maximum Output Voltage - Ambient  
 Temperature (VCC=5V, RL=2kΩ)

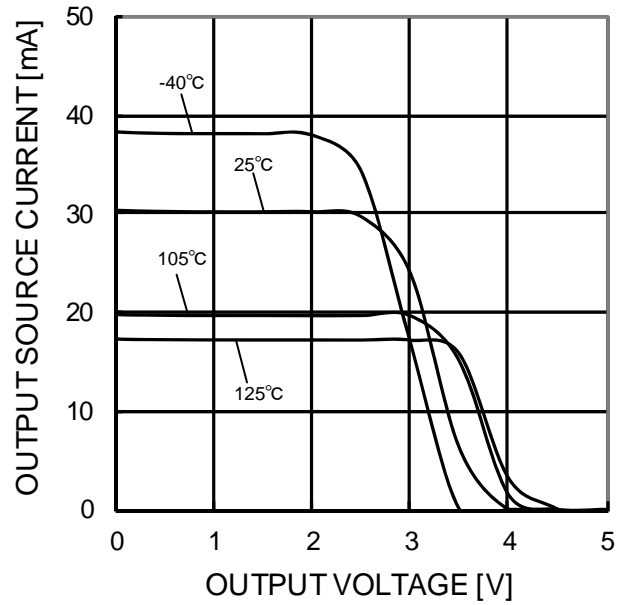

Figure 79.  
 Output Source Current - Output Voltage  
 (VCC=5V)

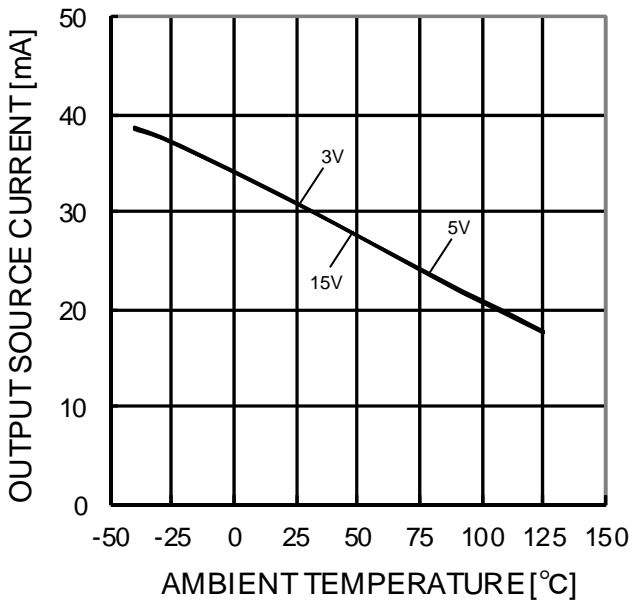

Figure 80.  
 Output Source Current - Ambient  
 Temperature (OUT=0V)

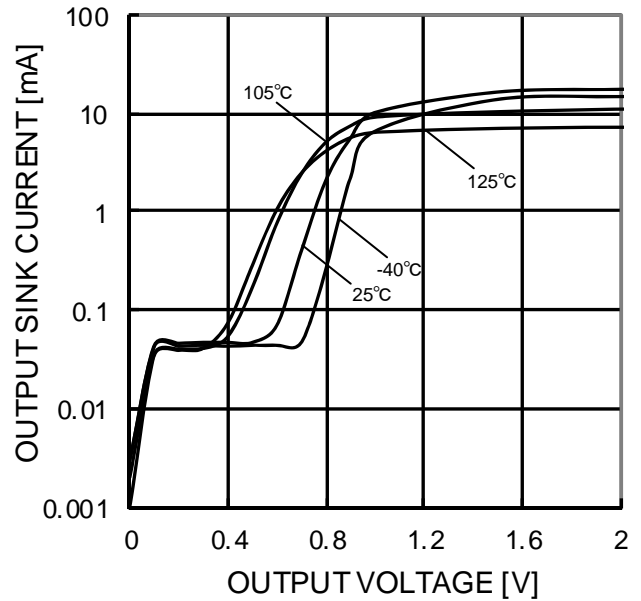

Figure 81.  
 Output Sink Current - Output Voltage  
 (VCC=5V)

(\*) The above data is measurement value of typical sample, it is not guaranteed.

OBA2902, BA2902S

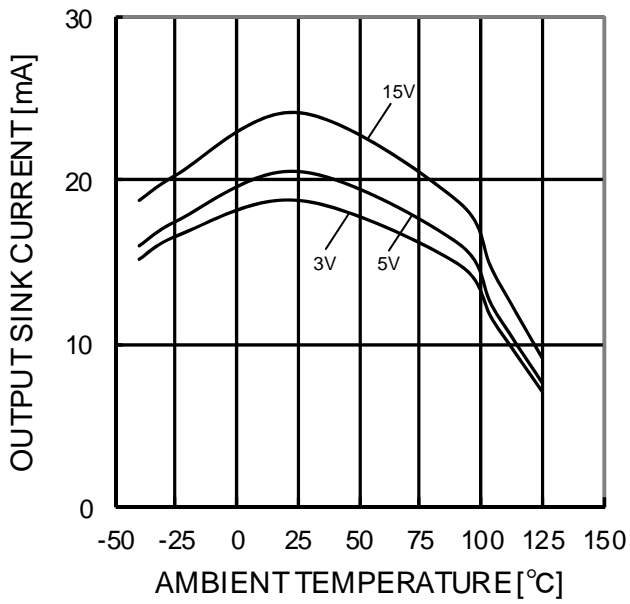

Figure 82.  
 Output Sink Current - Ambient Temperature  
 (OUT=VCC)

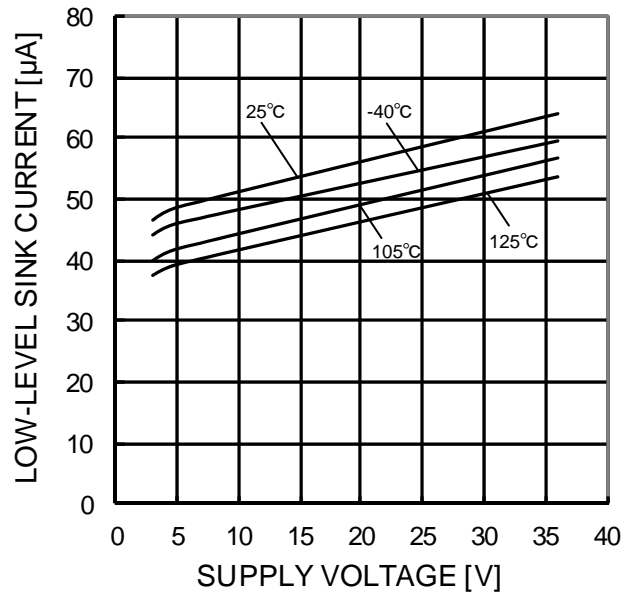

Figure 83.  
 Low Level Sink Current - Supply Voltage  
 (OUT=0.2V)

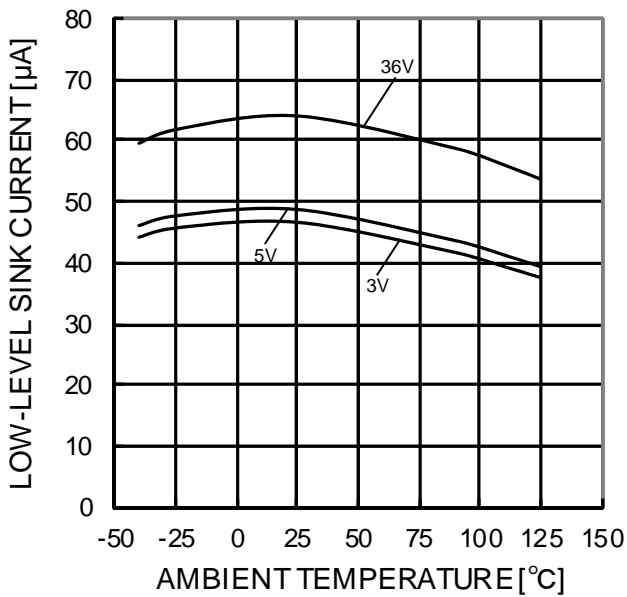

Figure 84.  
 Low Level Sink Current - Ambient Temperature  
 (OUT=0.2V)

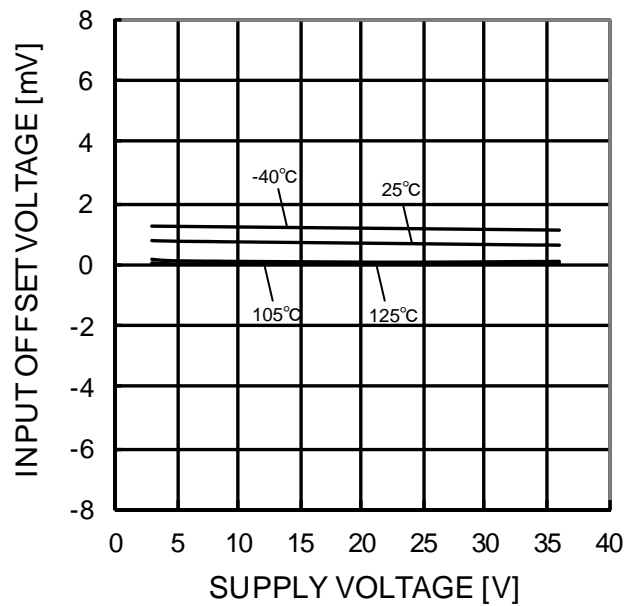

Figure 85.  
 Input Offset Voltage - Supply Voltage  
 (VICM=0V, OUT=1.4V)

(\*) The above data is measurement value of typical sample, it is not guaranteed.

OBA2902, BA2902S

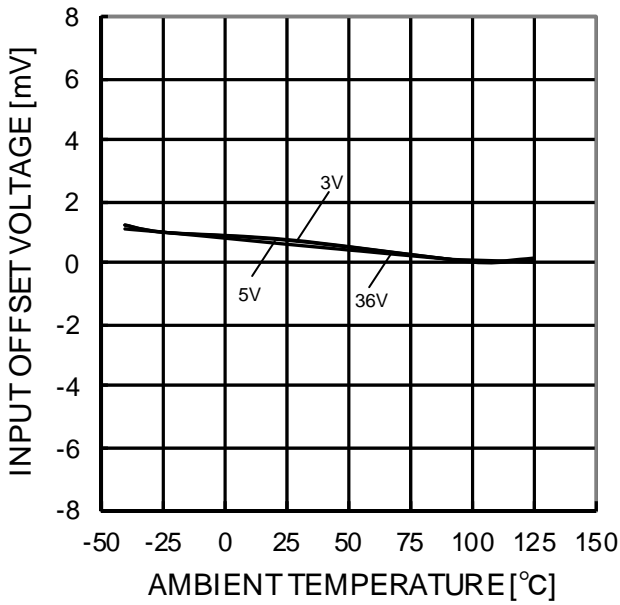

Figure 86.  
 Input Offset Voltage - Ambient Temperature  
 ( $V_{ICM}=0V$ ,  $OUT=1.4V$ )

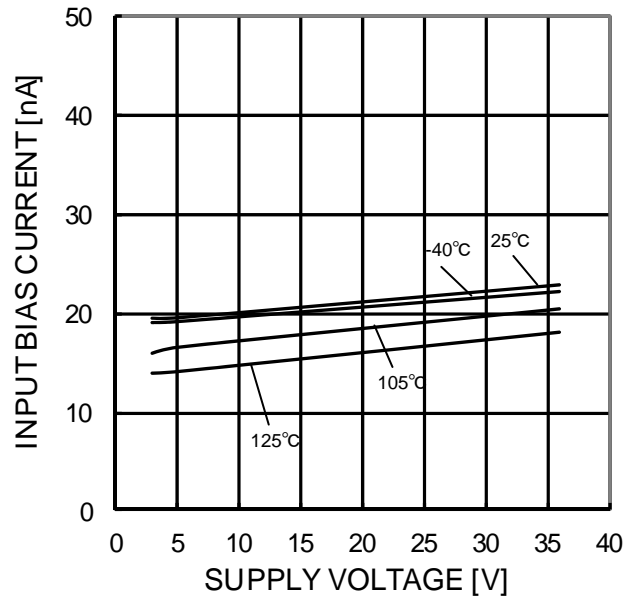

Figure 87.  
 Input Bias Current - Supply Voltage  
 ( $V_{ICM}=0V$ ,  $OUT=1.4V$ )

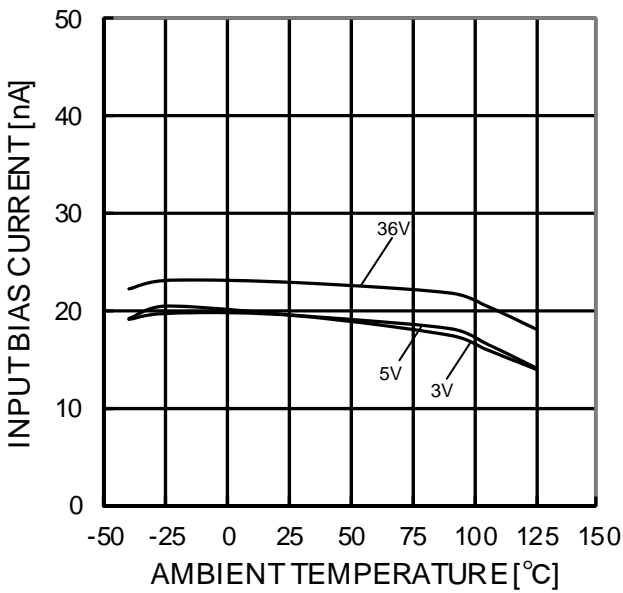

Figure 88.  
 Input Bias Current - Ambient Temperature  
 ( $V_{ICM}=0V$ ,  $OUT=1.4V$ )

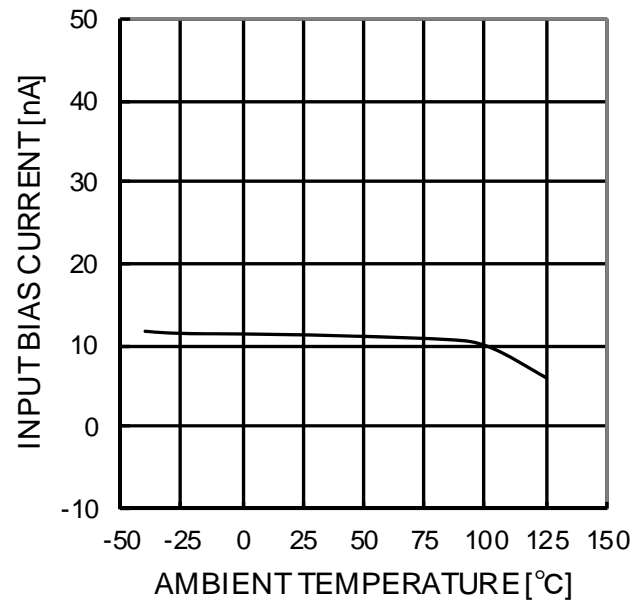

Figure 89.  
 Input Bias Current - Ambient Temperature  
 ( $VCC=30V$ ,  $V_{ICM}=28V$ ,  $OUT=1.4V$ )

(\*) The above data is measurement value of typical sample, it is not guaranteed.

OBA2902, BA2902S

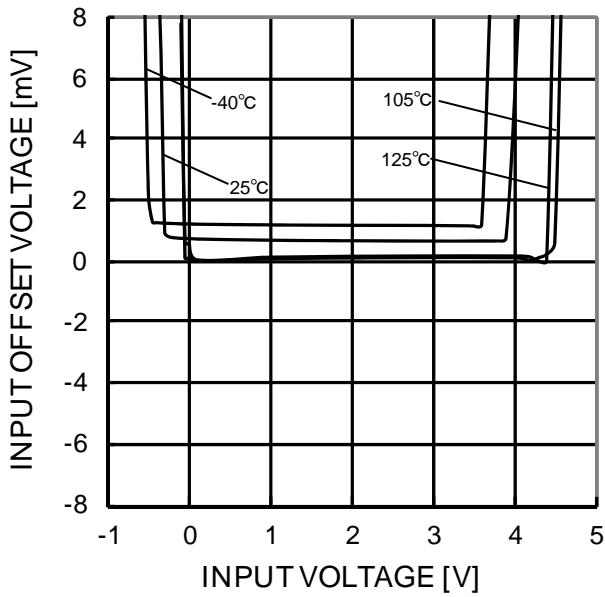

Figure 90.  
 Input Offset Voltage - Common Mode Input Voltage  
 (VCC=5V)

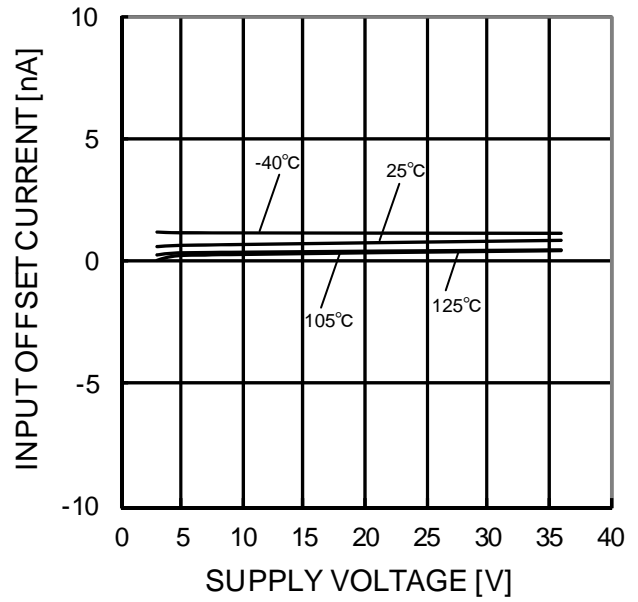

Figure 91.  
 Input Offset Current - Supply Voltage  
 (VICM=0V, OUT=1.4V)

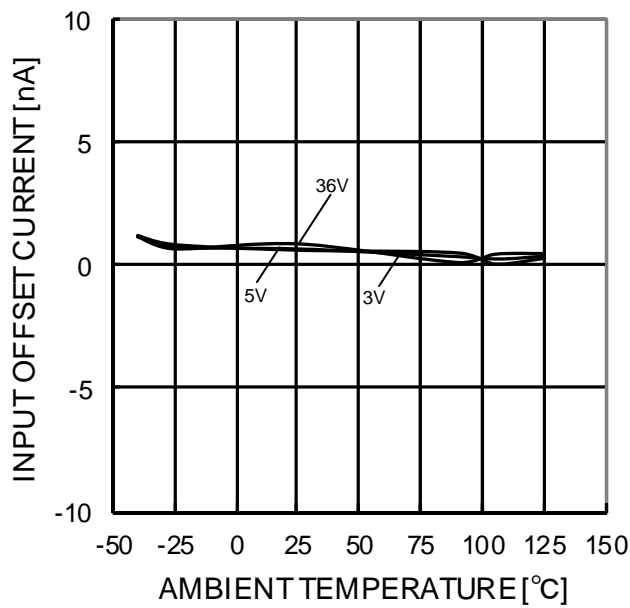

Figure 92.  
 Input Offset Current - Ambient Temperature  
 (VICM=0V, OUT=1.4V)

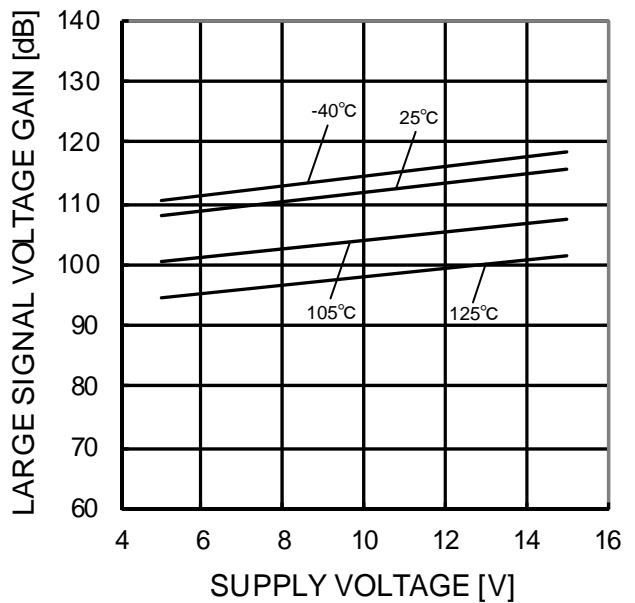

Figure 93.  
 Large Signal Voltage Gain - Supply Voltage  
 (RL=2kΩ)

(\*) The above data is measurement value of typical sample, it is not guaranteed.

OBA2902, BA2902S

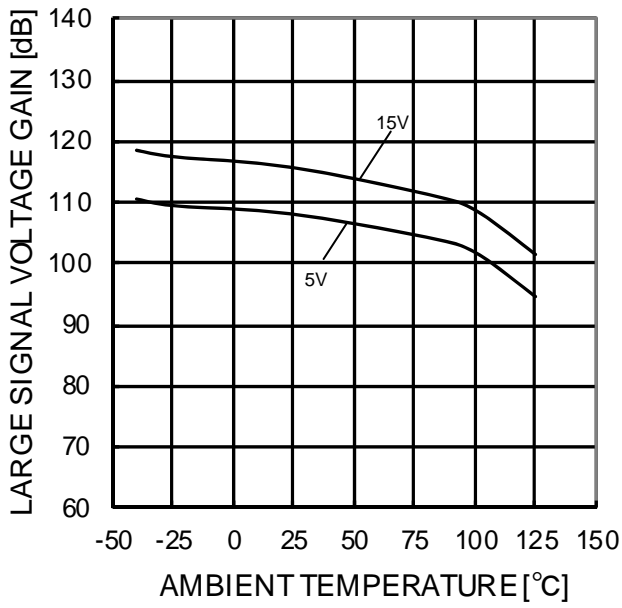

Figure 94.  
 Large Signal Voltage Gain - Ambient Temperature  
 (RL=2kΩ)

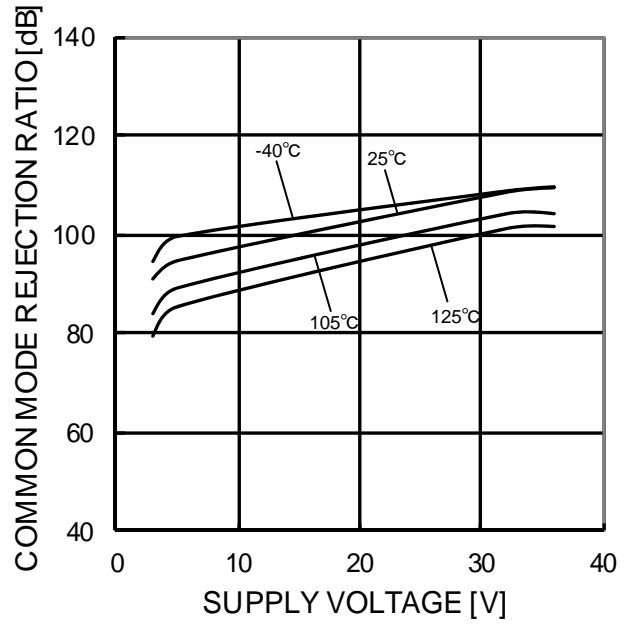

Figure 95.  
 Common Mode Rejection Ratio  
 - Supply Voltage

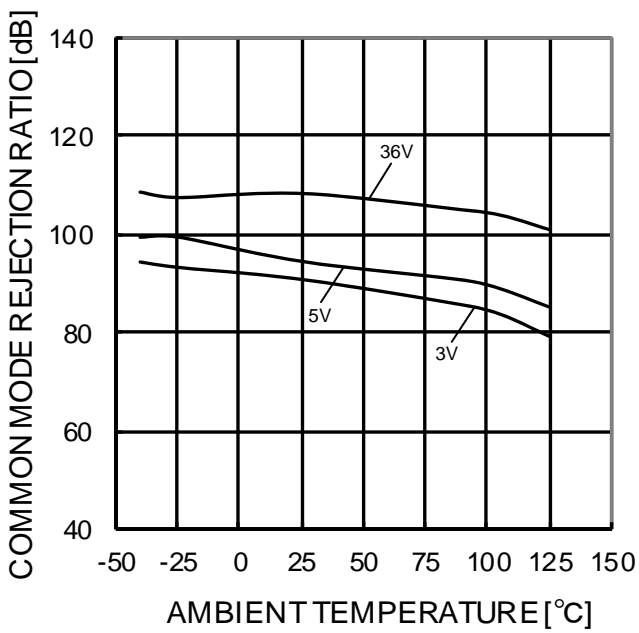

Figure 96.  
 Common Mode Rejection Ratio  
 - Ambient Temperature

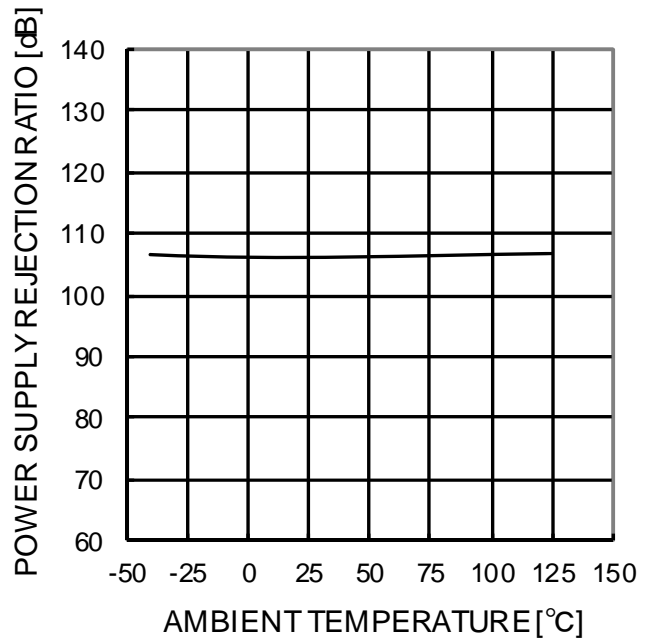

Figure 97.  
 Power Supply Rejection Ratio  
 - Ambient Temperature

(\*) The above data is measurement value of typical sample, it is not guaranteed.

**Application Information**  
**NULL method condition for Test Circuit 1**

VCC, VEE, E<sub>K</sub>, V<sub>ICM</sub> Unit : V

Parameter	VF	S1	S2	S3	BA10358 BA10324A				BA2904 BA2902				calculation
					VCC	VEE	E <sub>K</sub>	V <sub>ICM</sub>	VCC	VEE	E <sub>K</sub>	V <sub>ICM</sub>	
Input Offset Voltage	V <sub>F1</sub>	ON	ON	OFF	5	0	-1.4	0	5 to 30	0	-1.4	0	1
Input Offset Current	V <sub>F2</sub>	OFF	OFF	OFF	5	0	-1.4	0	5	0	-1.4	0	2
Input Bias Current	V <sub>F3</sub>	OFF	ON	OFF	5	0	-1.4	0	5	0	-1.4	0	3
	V <sub>F4</sub>	ON	OFF										
Large Signal Voltage Gain	V <sub>F5</sub>	ON	ON	ON	15	0	-1.4	0	15	0	-1.4	0	4
	V <sub>F6</sub>				15	0	-11.4	0	15	0	-11.4	0	
Common-mode Rejection Ratio (Input common-mode Voltage Range)	V <sub>F7</sub>	ON	ON	OFF	5	0	-1.4	0	5	0	-1.4	0	5
	V <sub>F8</sub>				5	0	-1.4	3.5	5	0	-1.4	3.5	
Power Supply Rejection Ratio	V <sub>F9</sub>	ON	ON	OFF	5	0	-1.4	0	5	0	-1.4	0	6
	V <sub>F10</sub>				30	0	-1.4	0	30	0	-1.4	0	

-Calculation-

1. Input Offset Voltage (V<sub>io</sub>)

$$V_{IO} = \frac{|V_{F1}|}{1+R_F/R_S} \text{ [V]}$$

2. Input Offset Current (I<sub>io</sub>)

$$I_{IO} = \frac{|V_{F2}-V_{F1}|}{R_i \times (1+R_F/R_S)} \text{ [A]}$$

3. Input Bias Current (I<sub>b</sub>)

$$I_B = \frac{|V_{F4}-V_{F3}|}{2 \times R_i \times (1+R_F/R_S)} \text{ [A]}$$

4. Large Signal Voltage Gain (A<sub>v</sub>)

$$A_V = 20 \text{Log} \frac{10 \times (1+R_F/R_S)}{|V_{F5}-V_{F6}|} \text{ [dB]}$$

5. Common-mode Rejection Ration (CMRR)

$$\text{CMRR} = 20 \text{Log} \frac{3.5 \times (1+R_F/R_S)}{|V_{F8}-V_{F7}|} \text{ [dB]}$$

6. Power supply rejection ratio (PSRR)

$$\text{PSRR} = 20 \text{Log} \frac{25 \times (1+R_F/R_S)}{|V_{F10} - V_{F9}|} \text{ [dB]}$$

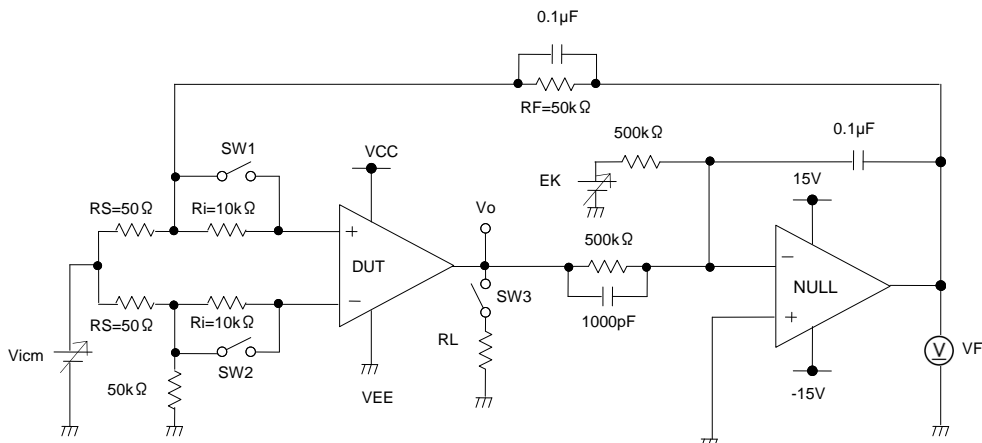

Figure . 98 Test circuit1 (one channel only)

Switch Condition for Test Circuit 2

SW No.	SW 1	SW 2	SW 3	SW 4	SW 5	SW 6	SW 7	SW 8	SW 9	SW 10	SW 11	SW 12	SW 13	SW 14
Supply Current	OFF	OFF	OFF	ON	OFF	ON	OFF	OFF	OFF	OFF	OFF	OFF	OFF	OFF
Maximum Output Voltage(High)	OFF	OFF	ON	OFF	OFF	ON	OFF	OFF	ON	OFF	OFF	OFF	ON	OFF
Maximum Output Voltage(Low)	OFF	OFF	ON	OFF	OFF	ON	OFF	OFF	OFF	OFF	OFF	OFF	ON	OFF
Output Source Current	OFF	OFF	ON	OFF	OFF	ON	OFF	OFF	OFF	OFF	OFF	OFF	OFF	ON
Output Sink Current	OFF	OFF	ON	OFF	OFF	ON	OFF	OFF	OFF	OFF	OFF	OFF	OFF	ON
Slew Rate	OFF	OFF	OFF	ON	OFF	OFF	OFF	ON	ON	ON	OFF	OFF	OFF	OFF
Gain Bandwidth Product	OFF	ON	OFF	OFF	ON	ON	OFF	OFF	ON	ON	OFF	OFF	OFF	OFF
Equivalent Input Noise Voltage	ON	OFF	OFF	OFF	ON	ON	OFF	OFF	OFF	OFF	ON	OFF	OFF	OFF

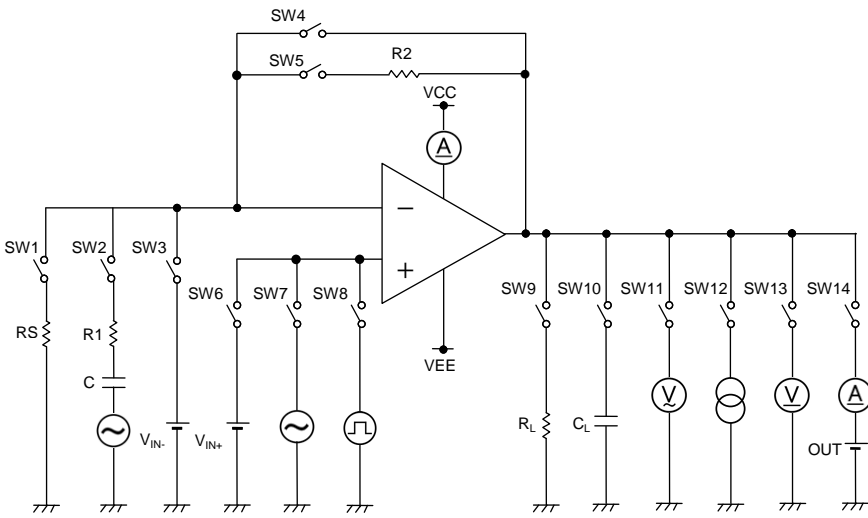

Figure 99. Test Circuit 2 (each Op-Amp)

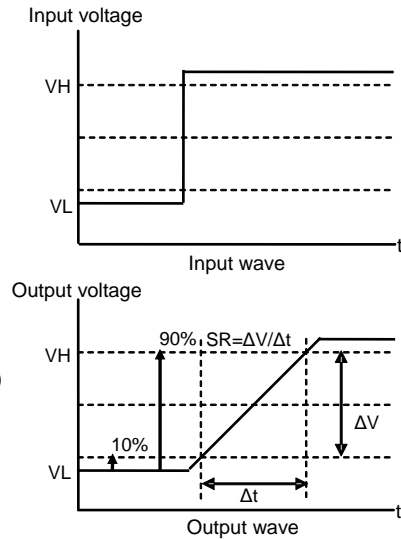
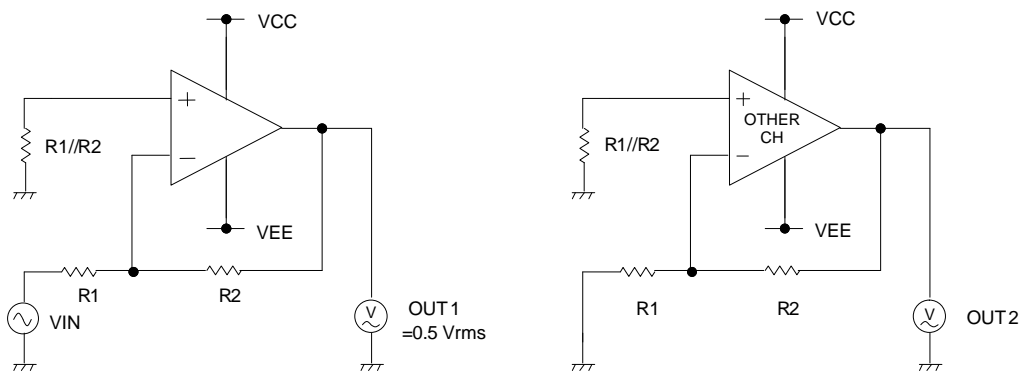

Figure 100. Slew Rate Input Waveform



$$CS = 20 \times \log \frac{100 \times OUT1}{OUT2}$$

Figure 101. Test Circuit 3(Channel Separation)  
 (R1=1kΩ,R2=100kΩ)

Examples of circuit

○Voltage follower

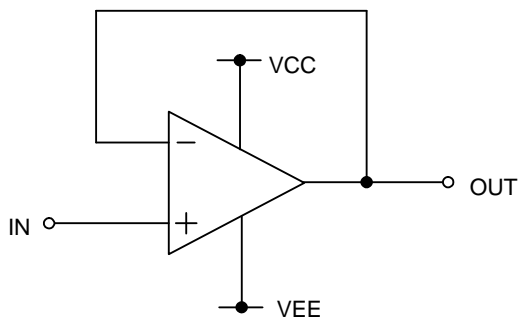

Voltage gain is 0 dB.  
 This circuit controls output voltage (OUT) equal input voltage (IN), and keeps OUT with stable because of high input impedance and low output impedance.  
 OUT is shown next formula.  
 $OUT=IN$

○Inverting amplifier

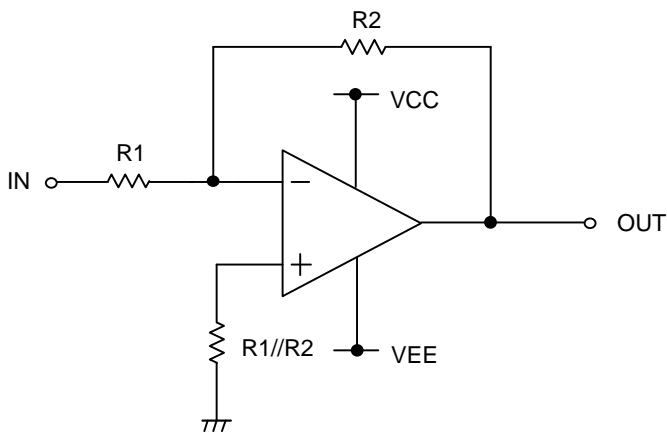

For inverting amplifier, IN is amplified by voltage gain decided R1 and R2, and phase reversed voltage is output.  
 OUT is shown next formula.  
 $OUT=-\left(\frac{R2}{R1}\right) \cdot IN$   
 Input impedance is R1.

○Non-inverting amplifier

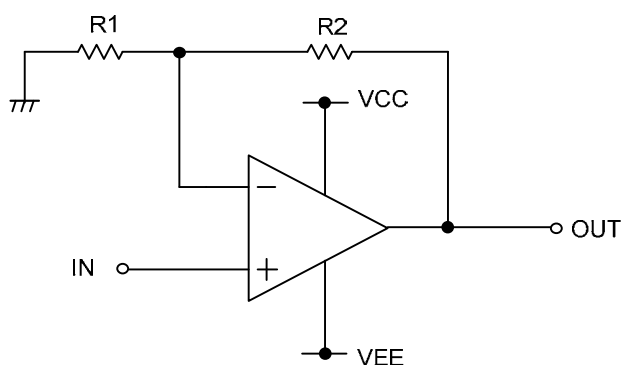

For non-inverting amplifier, IN is amplified by voltage gain decided R1 and R2, and phase is same with IN.  
 OUT is shown next formula.  
 $OUT= \left(1+\frac{R2}{R1}\right) \cdot IN$   
 This circuit realizes high input impedance because Input impedance is operational amplifier's input Impedance.

**Power Dissipation**

Power dissipation (total loss) indicates the power that the IC can consume at  $T_A=25^\circ\text{C}$  (normal temperature). As the IC consumes power, it heats up, causing its temperature to be higher than the ambient temperature. The allowable temperature that the IC can accept is limited. This depends on the circuit configuration, manufacturing process, and consumable power.

Power dissipation is determined by the allowable temperature within the IC (maximum junction temperature) and the thermal resistance of the package used (heat dissipation capability). Maximum junction temperature is typically equal to the maximum storage temperature. The heat generated through the consumption of power by the IC radiates from the mold resin or lead frame of the package. Thermal resistance, represented by the symbol  $\theta_{JA}$  °C/W, indicates this heat dissipation capability. Similarly, the temperature of an IC inside its package can be estimated by thermal resistance.

Figure 102 (a) shows the model of the thermal resistance of a package. The equation below shows how to compute for the Thermal resistance ( $\theta_{JA}$ ), given the ambient temperature ( $T_A$ ), maximum junction temperature ( $T_{Jmax}$ ), and power dissipation ( $P_D$ ).

$$\theta_{JA} = (T_{Jmax} - T_A) / P_D \quad ^\circ\text{C/W}$$

The derating curve in Figure 102 (b) indicates the power that the IC can consume with reference to ambient temperature. Power consumption of the IC begins to attenuate at certain temperatures. This gradient is determined by Thermal resistance ( $\theta_{JA}$ ), which depends on the chip size, power consumption, package, ambient temperature, package condition, wind velocity, etc. This may also vary even when the same of package is used. Thermal reduction curve indicates a reference value measured at a specified condition. Figure 102. (c) to (f) show a derating curve for an example of BA10358, BA10324A, BA2904S, BA2904, BA2904W, BA2902S, BA2902.

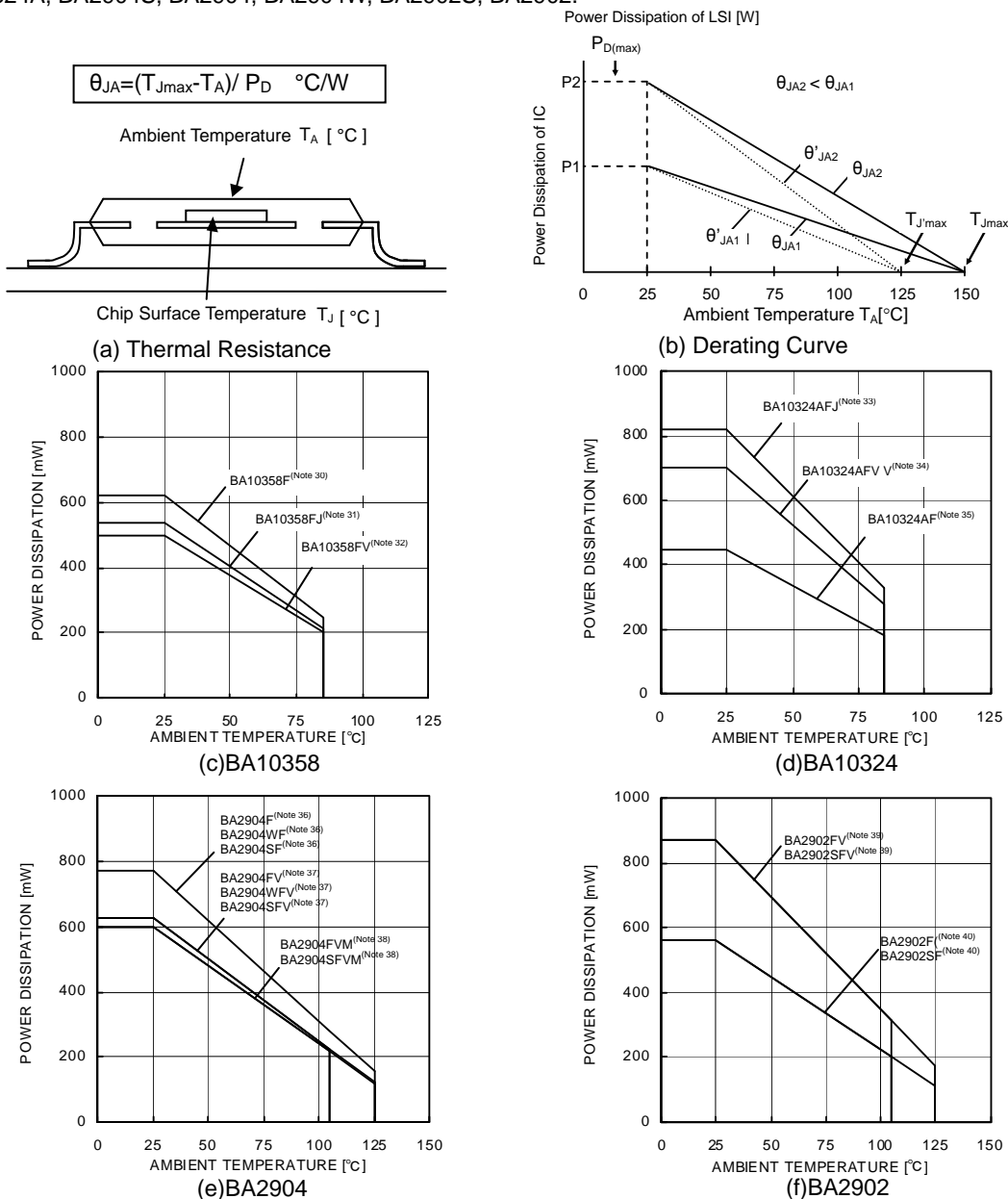

(Note 30)	(Note 31)	(Note 32)	(Note 33)	(Note 34)	(Note 35)	(Note 36)	(Note 37)	(Note 38)	(Note 39)	(Note 40)	Unit
6.2	5.4	5.0	8.2	7.0	4.5	6.2	5.0	4.7	7.0	4.5	mW/°C

When using the unit above  $T_A=25^\circ\text{C}$ , subtract the value above per degree  $^\circ\text{C}$ .

Permissible dissipation is the value when FR4 glass epoxy board 70mm x70mm x1.6mm (copper foil area below 3%) is mounted.

Figure 102. Thermal resistance and derating

## Operational Notes

- 1. Reverse Connection of Power Supply**

Connecting the power supply in reverse polarity can damage the IC. Take precautions against reverse polarity when connecting the power supply, such as mounting an external diode between the power supply and the IC's power supply terminals.
- 2. Power Supply Lines**

Design the PCB layout pattern to provide low impedance ground and supply lines. Separate the ground and supply lines of the digital and analog blocks to prevent noise in the ground and supply lines of the digital block from affecting the analog block. Furthermore, connect a capacitor to ground at all power supply pins. Consider the effect of temperature and aging on the capacitance value when using electrolytic capacitors.
- 3. Ground Voltage**

Ensure that no pins are at a voltage below that of the ground pin at any time, even during transient condition.
- 4. Ground Wiring Pattern**

When using both small-signal and large-current GND traces, the two ground traces should be routed separately but connected to a single ground at the reference point of the application board to avoid fluctuations in the small-signal ground caused by large currents. Also ensure that the GND traces of external components do not cause variations on the GND voltage. The power supply and ground lines must be as short and thick as possible to reduce line impedance.
- 5. Thermal Consideration**

Should by any chance the power dissipation rating be exceeded, the rise in temperature of the chip may result in deterioration of the properties of the chip. The absolute maximum rating of the Pd stated in this specification is when the IC is mounted on a 70mm x 70mm x 1.6mm glass epoxy board. In case of exceeding this absolute maximum rating, increase the board size and copper area to prevent exceeding the Pd rating.
- 6. Recommended Operating Conditions**

These conditions represent a range within which the expected characteristics of the IC can be approximately obtained. The electrical characteristics are guaranteed under the conditions of each parameter.
- 7. Inrush Current**

When power is first supplied to the IC, it is possible that the internal logic may be unstable and inrush current may flow instantaneously due to the internal powering sequence and delays, especially if the IC has more than one power supply. Therefore, give special consideration to power coupling capacitance, power wiring, width of GND wiring, and routing of connections.
- 8. Operation Under Strong Electromagnetic Field**

Operating the IC in the presence of a strong electromagnetic field may cause the IC to malfunction.
- 9. Testing on Application Boards**

When testing the IC on an application board, connecting a capacitor directly to a low-impedance output pin may subject the IC to stress. Always discharge capacitors completely after each process or step. The IC's power supply should always be turned off completely before connecting or removing it from the test setup during the inspection process. To prevent damage from static discharge, ground the IC during assembly and use similar precautions during transport and storage.
- 10. Inter-pin Short and Mounting Errors**

Ensure that the direction and position are correct when mounting the IC on the PCB. Incorrect mounting may result in damaging the IC. Avoid nearby pins being shorted to each other especially to ground. Inter-pin shorts could be due to many reasons such as metal particles, water droplets (in very humid environment) and unintentional solder bridge deposited in between pins during assembly to name a few.

Operational Notes – continued

11. Regarding Input Pins of the IC

This monolithic IC contains P+ isolation and P substrate layers between adjacent elements in order to keep them isolated. P-N junctions are formed at the intersection of the P layers with the N layers of other elements, creating a parasitic diode or transistor. For example (refer to figure below):

- When  $GND > Pin A$  and  $GND > Pin B$ , the P-N junction operates as a parasitic diode.
- When  $GND > Pin B$ , the P-N junction operates as a parasitic transistor.

Parasitic diodes inevitably occur in the structure of the IC. The operation of parasitic diodes can result in mutual interference among circuits, operational faults, or physical damage. Therefore, conditions that cause these diodes to operate, such as applying a voltage lower than the GND voltage to an input pin (and thus to the P substrate) should be avoided.

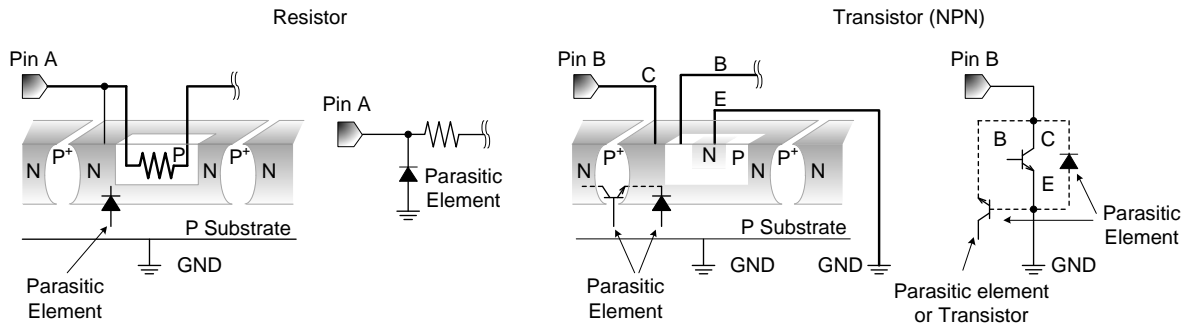

Figure 103. Example of Monolithic IC Structure

12. Unused Circuits

When there are unused circuits it is recommended that they be connected as in Figure 104, setting the non-inverting input terminal to a potential within the in-phase input voltage range ( $V_{ICM}$ ).

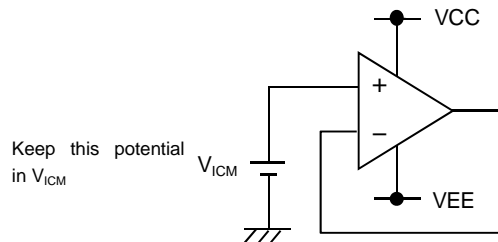

Figure 104. Disable Circuit Example

13. Input Terminal Voltage

(BA10358 / BA10324) Applying  $VEE + 32V$ , (BA2904 / BA2902) Applying  $VEE + 36V$  to the input terminal is possible without causing deterioration of the electrical characteristics or destruction, irrespective of the supply voltage. However, this does not ensure normal circuit operation. Please note that the circuit operates normally only when the input voltage is within the common mode input voltage range of the electric characteristics.

14. Power Supply (signal / dual)

The op-amp operates when the specified voltage supplied is between VCC and VEE. Therefore, the single supply op-amp can be used as a dual supply op-amp as well.

15. Terminal short-circuits

When the output and VCC terminals are shorted, excessive output current may flow, resulting in undue heat generation and, subsequently, destruction.

16. IC Handling

Applying mechanical stress to the IC by deflecting or bending the board may cause fluctuations in the electrical characteristics due to piezo resistance effects.

17. Output Capacitor

If a large capacitor is connected between the output pin and VEE pin, current from the charged capacitor will flow into the output pin and may destroy the IC when the VCC pin is shorted to ground or pulled down to 0V. Use a capacitor smaller than 0.1uF between output pin and VEE pin.

Physical Dimensions Tape and Reel Information

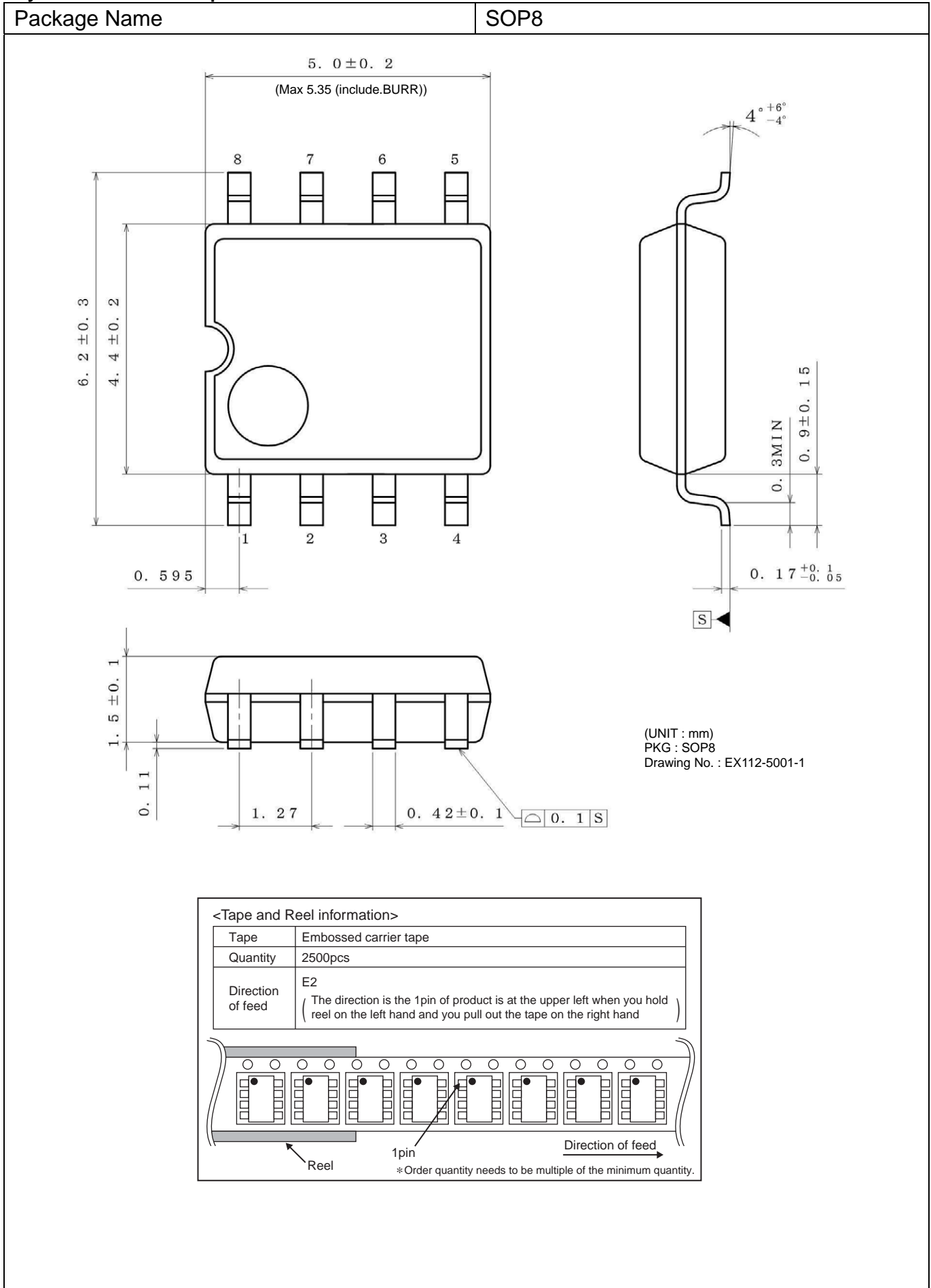

Physical Dimension, Tape and Reel Information – continued

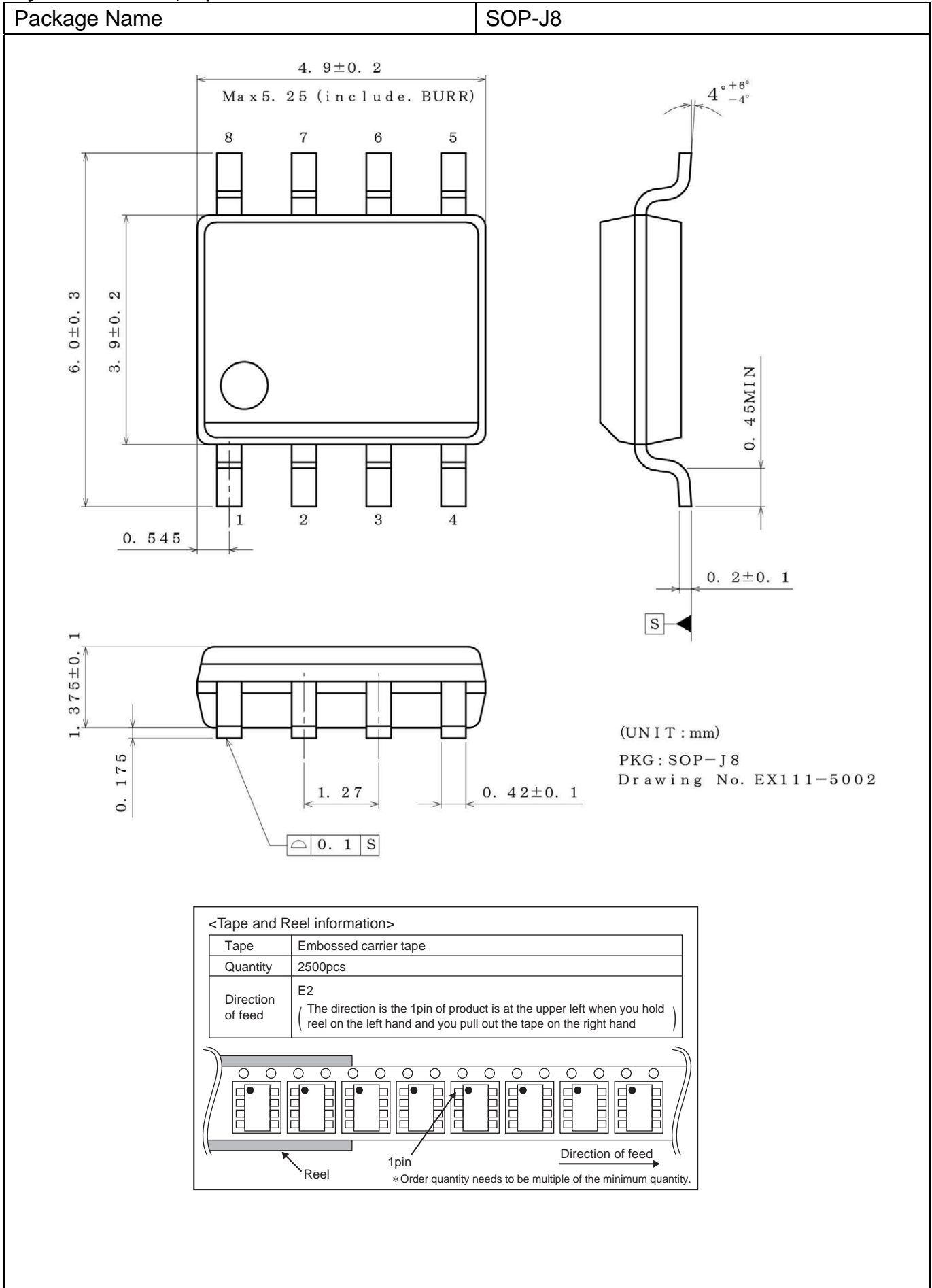

Physical Dimension, Tape and Reel Information – continued

Package Name	SSOP-B8
--------------	---------

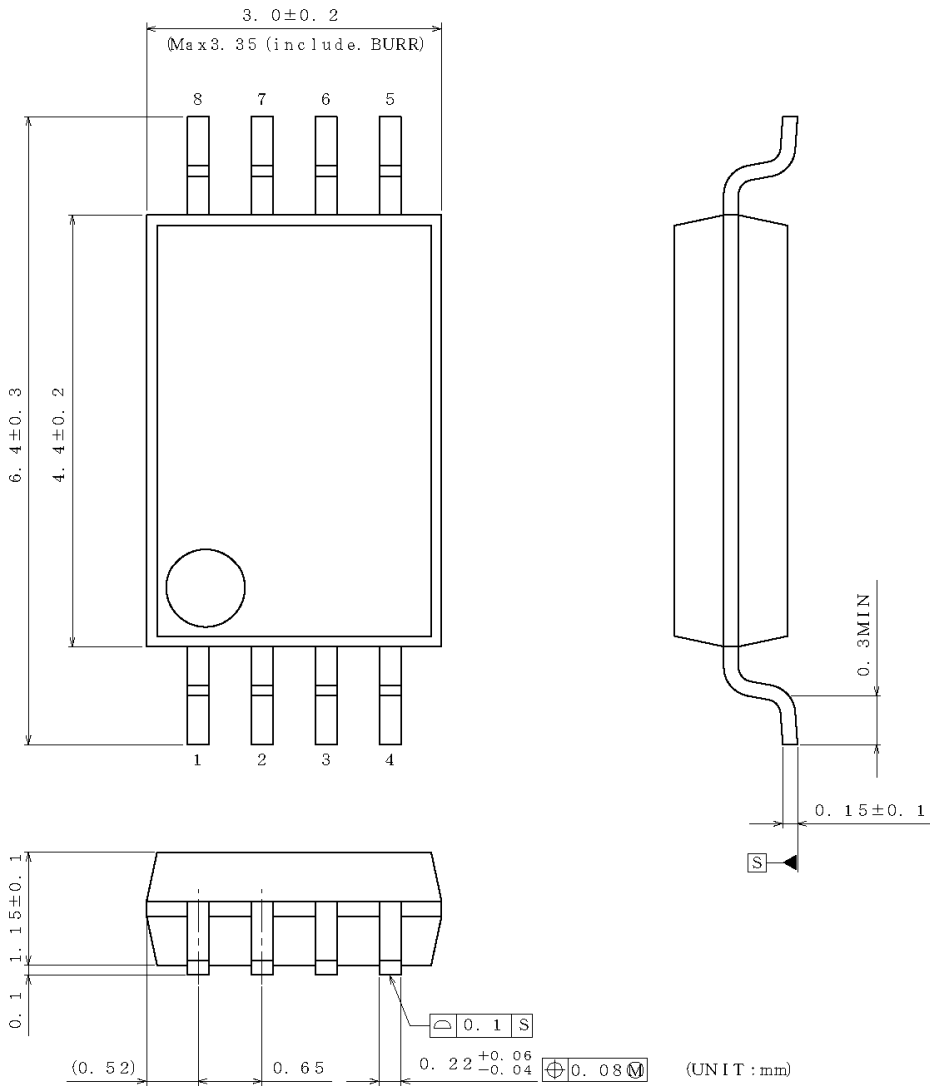

PKG : SSOP-B8  
 Drawing No. EX151-5002

<Tape and Reel information>

Tape	Embossed carrier tape
Quantity	2500pcs
Direction of feed	E2 ( The direction is the 1pin of product is at the upper left when you hold reel on the left hand and you pull out the tape on the right hand )

Reel      1pin      Direction of feed

\* Order quantity needs to be multiple of the minimum quantity.

Physical Dimension, Tape and Reel Information – continued

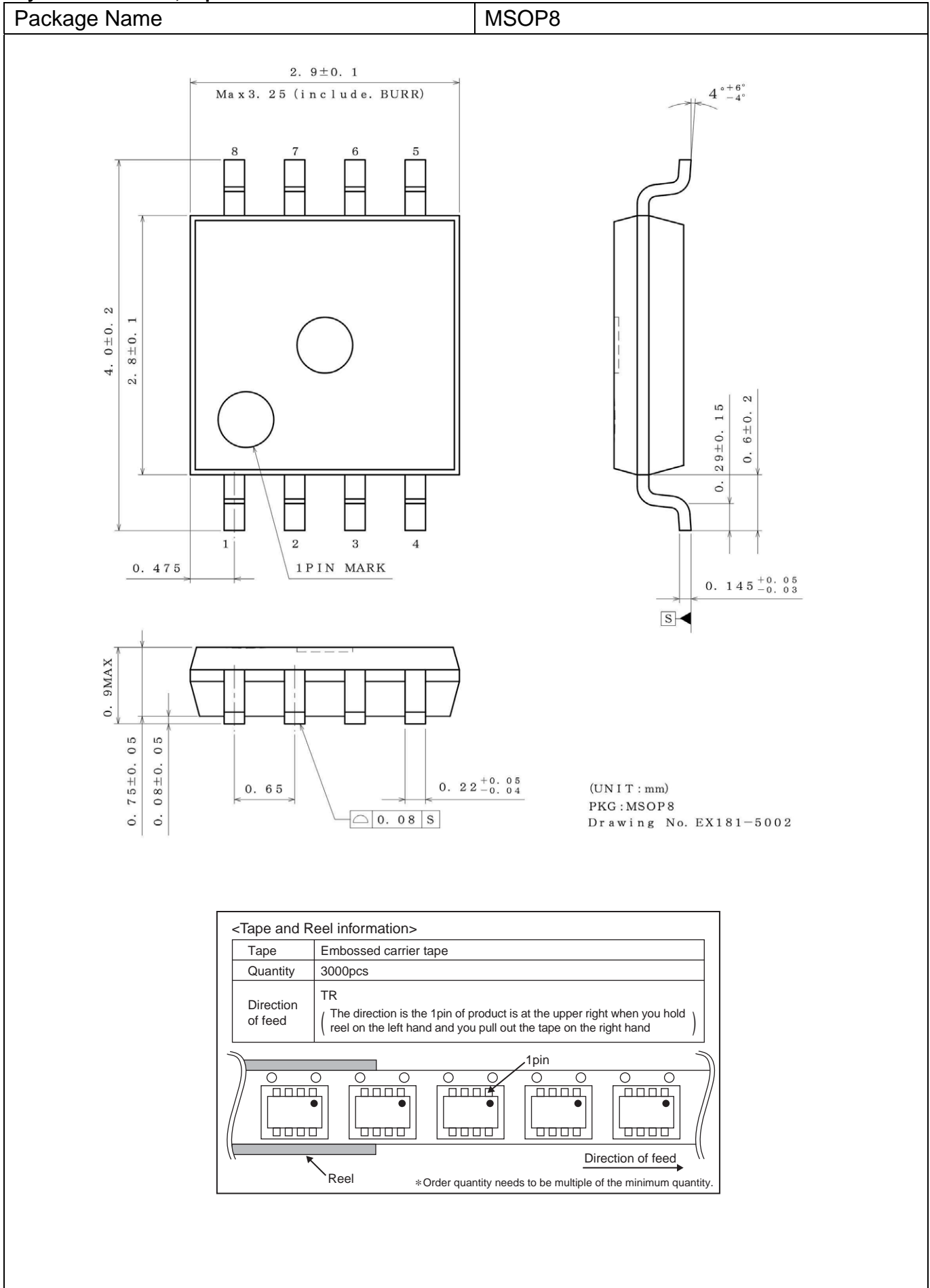

Physical Dimension, Tape and Reel Information – continued

Package Name	SOP14
--------------	-------

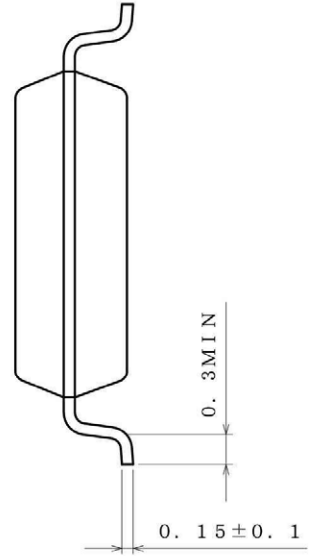
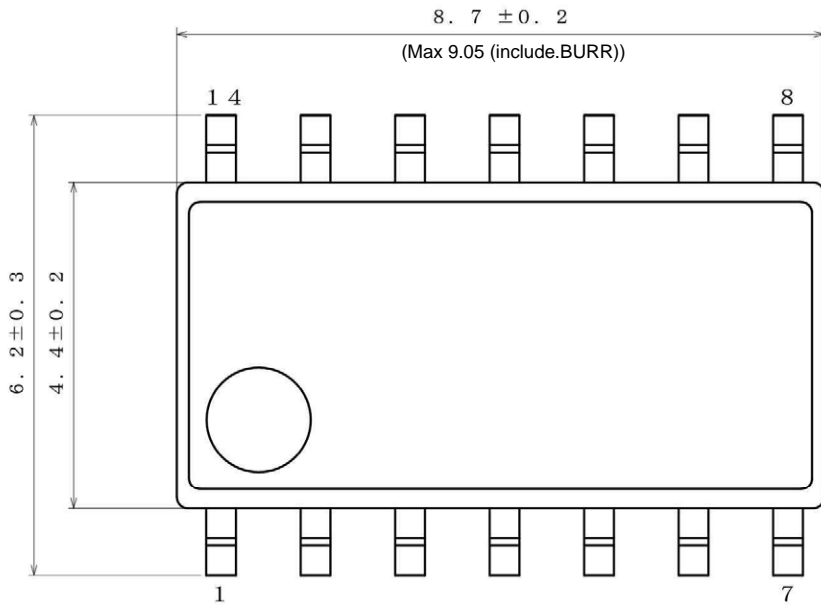

(UNIT : mm)  
 PKG : SOP14  
 Drawing No. : EX113-5001

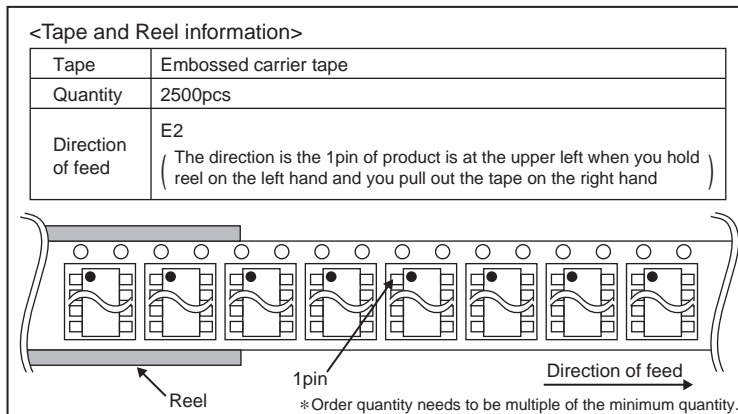

Physical Dimension, Tape and Reel Information – continued

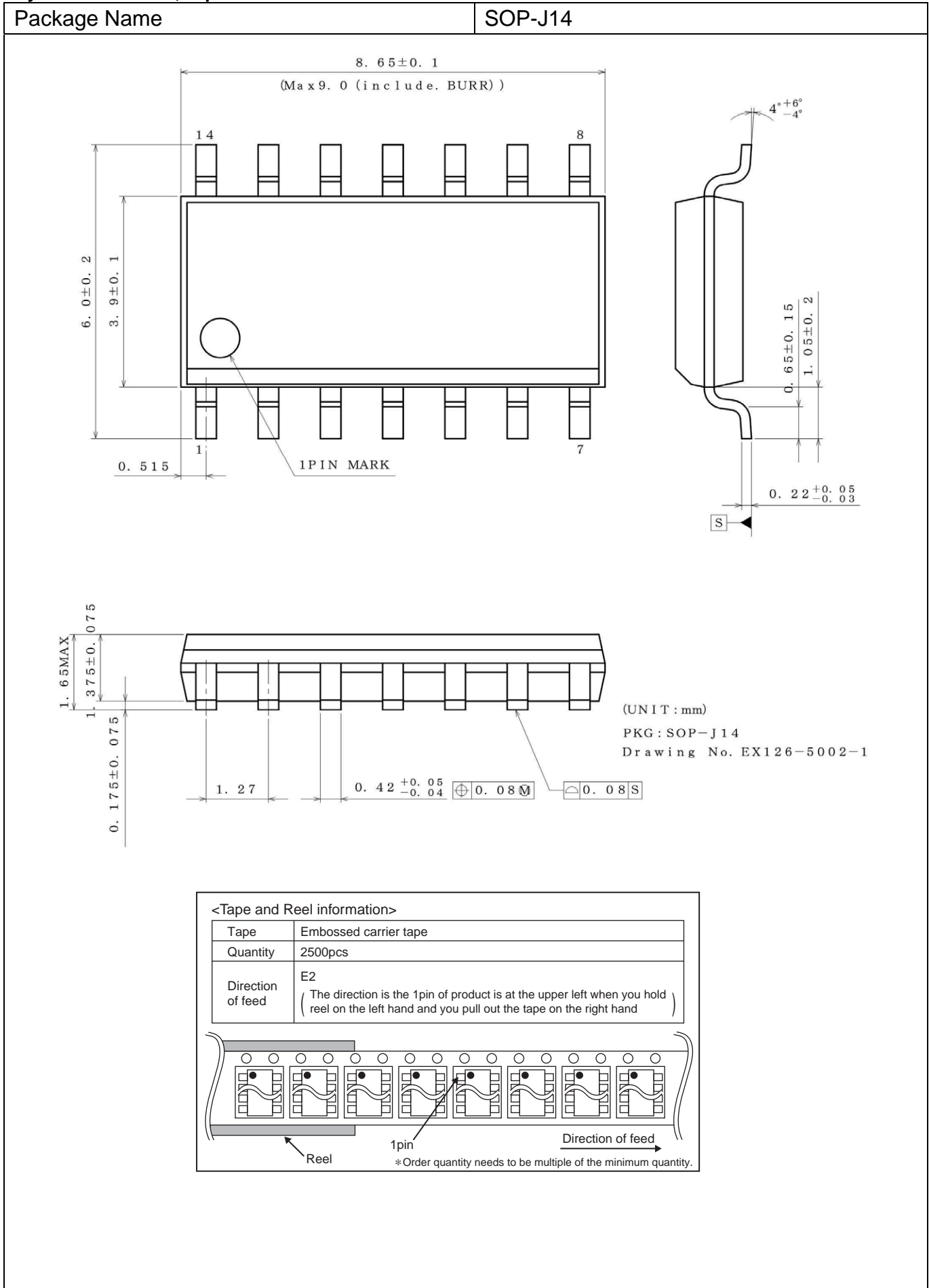

Physical Dimension, Tape and Reel Information – continued

Package Name	SSOP-B14
--------------	----------

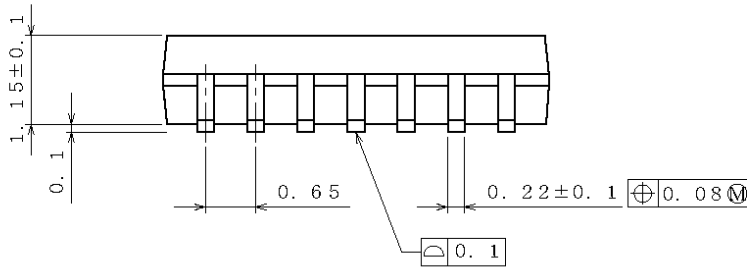
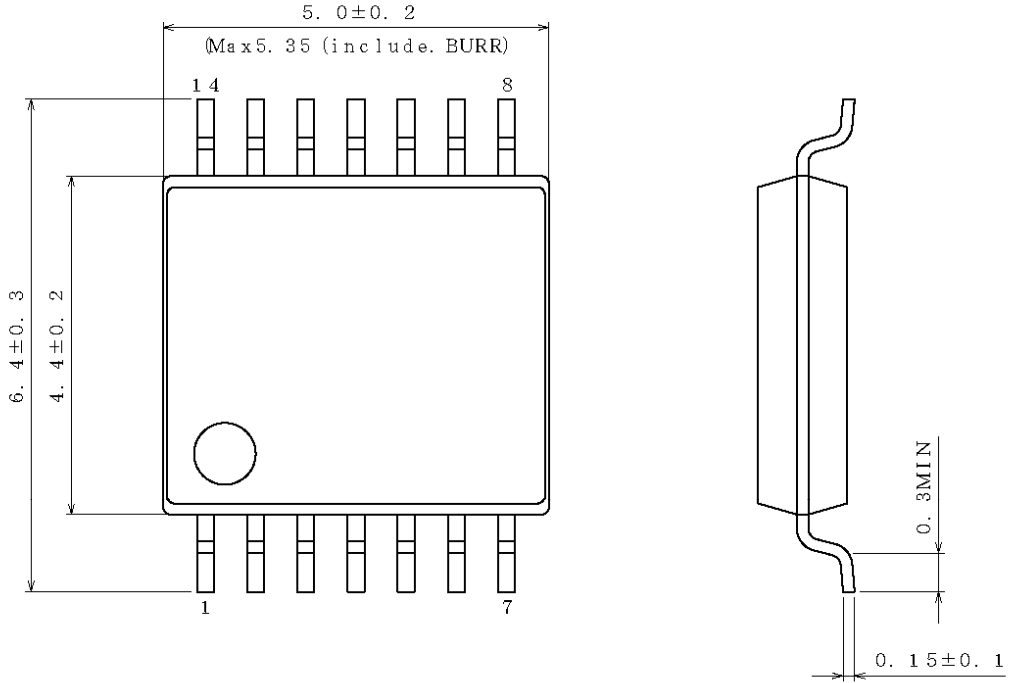

(UNIT : mm)  
 PKG : SSOP-B14  
 Drawing No. EX152-5002

<Tape and Reel information>

Tape	Embossed carrier tape
Quantity	2500pcs
Direction of feed	E2 ( The direction is the 1pin of product is at the upper left when you hold reel on the left hand and you pull out the tape on the right hand )

Reel      1pin      Direction of feed

\*Order quantity needs to be multiple of the minimum quantity.

Marking Diagrams

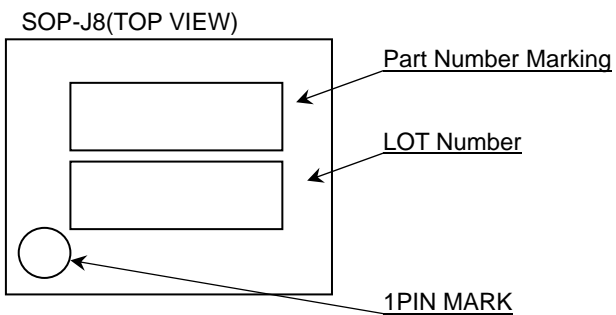
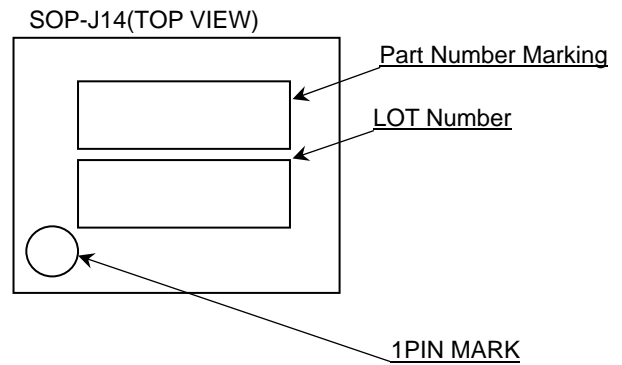
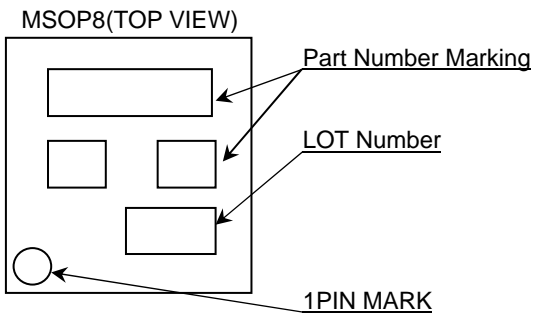
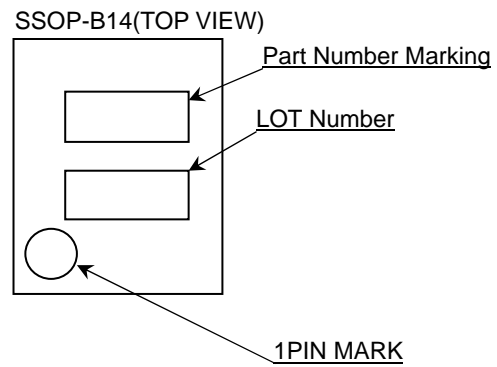
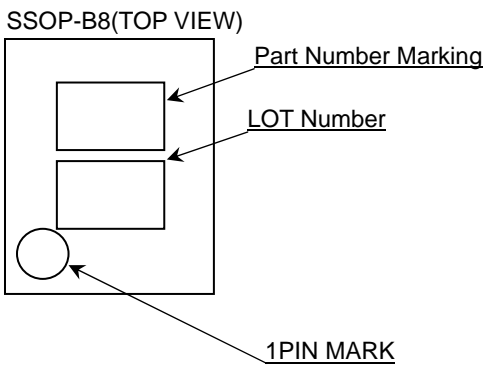
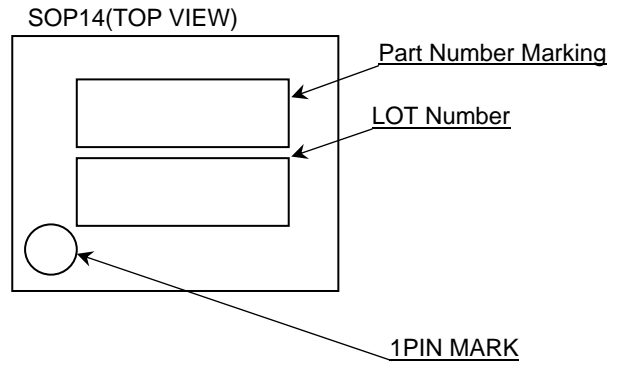
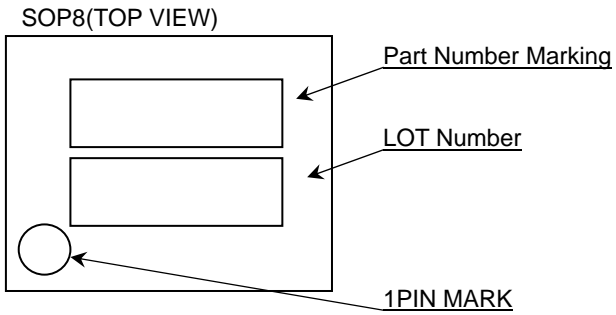

Product Name		Package Type	Marking
BA10358	F	SOP8	10358
	FJ	SOP-J8	
	FV	SSOP-B8	358
BA10324A	F	SOP14	BA10324AF
	FJ	SOP-J14	BA10324A
	FV	SSOP-B14	324A
BA2904	F	SOP8	2904
	FV	SSOP-B8	
	FVM	MSOP8	
BA2904W	F	SOP8	2904S
	FV	SSOP-B8	
BA2904S	F	SOP8	2904S
	FV	SSOP-B8	04S
	FVM	MSOP8	2904S
BA2902	F	SOP14	BA2902F
	FV	SSOP-B14	2902
BA2902S	F	SOP14	2902S
	FV	SSOP-B14	

Land pattern data

all dimensions in mm

PKG	Land pitch e	Land space MIE	Land length $\geq \varnothing 2$	Land width b2
SOP8	1.27	4.60	1.10	0.76
SSOP-B8	0.65	4.60	1.20	0.35
SOP-J8	1.27	3.90	1.35	0.76
MSOP8	0.65	2.62	0.99	0.35
SOP14	1.27	4.60	1.10	0.76
SSOP-B14	0.65	4.60	1.20	0.35
SOP-J14	1.27	3.90	1.35	0.76

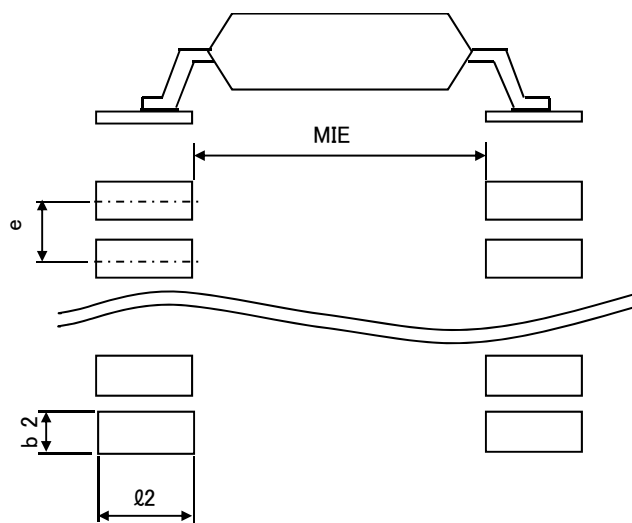

SOP8, SSOP-B8, SOP-J8, MSOP8  
 SOP14, SSOP-B14, SOP-J14

**Revision History**

Date	Revision	Changes
14.SEP.2012	001	New Release
11.Jan.2013	002	Land pattern data inserted.
23.Jan.2014	003	The Differential Input Voltage and Input Common-mode Voltage Range are updated in absolute maximum ratings for BA10358 and BA10324A. The input current is added in absolute maximum ratings.

# Notice

## Precaution on using ROHM Products

- Our Products are designed and manufactured for application in ordinary electronic equipments (such as AV equipment, OA equipment, telecommunication equipment, home electronic appliances, amusement equipment, etc.). If you intend to use our Products in devices requiring extremely high reliability (such as medical equipment <sup>(Note 1)</sup>, transport equipment, traffic equipment, aircraft/spacecraft, nuclear power controllers, fuel controllers, car equipment including car accessories, safety devices, etc.) and whose malfunction or failure may cause loss of human life, bodily injury or serious damage to property ("Specific Applications"), please consult with the ROHM sales representative in advance. Unless otherwise agreed in writing by ROHM in advance, ROHM shall not be in any way responsible or liable for any damages, expenses or losses incurred by you or third parties arising from the use of any ROHM's Products for Specific Applications.

(Note1) Medical Equipment Classification of the Specific Applications

JAPAN	USA	EU	CHINA
CLASS III	CLASS III	CLASS II b	CLASS III
CLASS IV		CLASS III	

- ROHM designs and manufactures its Products subject to strict quality control system. However, semiconductor products can fail or malfunction at a certain rate. Please be sure to implement, at your own responsibilities, adequate safety measures including but not limited to fail-safe design against the physical injury, damage to any property, which a failure or malfunction of our Products may cause. The following are examples of safety measures:
  - Installation of protection circuits or other protective devices to improve system safety
  - Installation of redundant circuits to reduce the impact of single or multiple circuit failure
- Our Products are designed and manufactured for use under standard conditions and not under any special or extraordinary environments or conditions, as exemplified below. Accordingly, ROHM shall not be in any way responsible or liable for any damages, expenses or losses arising from the use of any ROHM's Products under any special or extraordinary environments or conditions. If you intend to use our Products under any special or extraordinary environments or conditions (as exemplified below), your independent verification and confirmation of product performance, reliability, etc. prior to use, must be necessary:
  - Use of our Products in any types of liquid, including water, oils, chemicals, and organic solvents
  - Use of our Products outdoors or in places where the Products are exposed to direct sunlight or dust
  - Use of our Products in places where the Products are exposed to sea wind or corrosive gases, including Cl<sub>2</sub>, H<sub>2</sub>S, NH<sub>3</sub>, SO<sub>2</sub>, and NO<sub>2</sub>
  - Use of our Products in places where the Products are exposed to static electricity or electromagnetic waves
  - Use of our Products in proximity to heat-producing components, plastic cords, or other flammable items
  - Sealing or coating our Products with resin or other coating materials
  - Use of our Products without cleaning residue of flux (even if you use no-clean type fluxes, cleaning residue of flux is recommended); or Washing our Products by using water or water-soluble cleaning agents for cleaning residue after soldering
  - Use of the Products in places subject to dew condensation
- The Products are not subject to radiation-proof design.
- Please verify and confirm characteristics of the final or mounted products in using the Products.
- In particular, if a transient load (a large amount of load applied in a short period of time, such as pulse. is applied, confirmation of performance characteristics after on-board mounting is strongly recommended. Avoid applying power exceeding normal rated power; exceeding the power rating under steady-state loading condition may negatively affect product performance and reliability.
- De-rate Power Dissipation (Pd) depending on Ambient temperature (Ta). When used in sealed area, confirm the actual ambient temperature.
- Confirm that operation temperature is within the specified range described in the product specification.
- ROHM shall not be in any way responsible or liable for failure induced under deviant condition from what is defined in this document.

## Precaution for Mounting / Circuit board design

- When a highly active halogenous (chlorine, bromine, etc.) flux is used, the residue of flux may negatively affect product performance and reliability.
- In principle, the reflow soldering method must be used; if flow soldering method is preferred, please consult with the ROHM representative in advance.

For details, please refer to ROHM Mounting specification

### Precautions Regarding Application Examples and External Circuits

1. If change is made to the constant of an external circuit, please allow a sufficient margin considering variations of the characteristics of the Products and external components, including transient characteristics, as well as static characteristics.
2. You agree that application notes, reference designs, and associated data and information contained in this document are presented only as guidance for Products use. Therefore, in case you use such information, you are solely responsible for it and you must exercise your own independent verification and judgment in the use of such information contained in this document. ROHM shall not be in any way responsible or liable for any damages, expenses or losses incurred by you or third parties arising from the use of such information.

### Precaution for Electrostatic

This Product is electrostatic sensitive product, which may be damaged due to electrostatic discharge. Please take proper caution in your manufacturing process and storage so that voltage exceeding the Products maximum rating will not be applied to Products. Please take special care under dry condition (e.g. Grounding of human body / equipment / solder iron, isolation from charged objects, setting of Ionizer, friction prevention and temperature / humidity control).

### Precaution for Storage / Transportation

1. Product performance and soldered connections may deteriorate if the Products are stored in the places where:
  - [a] the Products are exposed to sea winds or corrosive gases, including Cl<sub>2</sub>, H<sub>2</sub>S, NH<sub>3</sub>, SO<sub>2</sub>, and NO<sub>2</sub>
  - [b] the temperature or humidity exceeds those recommended by ROHM
  - [c] the Products are exposed to direct sunshine or condensation
  - [d] the Products are exposed to high Electrostatic
2. Even under ROHM recommended storage condition, solderability of products out of recommended storage time period may be degraded. It is strongly recommended to confirm solderability before using Products of which storage time is exceeding the recommended storage time period.
3. Store / transport cartons in the correct direction, which is indicated on a carton with a symbol. Otherwise bent leads may occur due to excessive stress applied when dropping of a carton.
4. Use Products within the specified time after opening a humidity barrier bag. Baking is required before using Products of which storage time is exceeding the recommended storage time period.

### Precaution for Product Label

QR code printed on ROHM Products label is for ROHM's internal use only.

### Precaution for Disposition

When disposing Products please dispose them properly using an authorized industry waste company.

### Precaution for Foreign Exchange and Foreign Trade act

Since our Products might fall under controlled goods prescribed by the applicable foreign exchange and foreign trade act, please consult with ROHM representative in case of export.

### Precaution Regarding Intellectual Property Rights

1. All information and data including but not limited to application example contained in this document is for reference only. ROHM does not warrant that foregoing information or data will not infringe any intellectual property rights or any other rights of any third party regarding such information or data. ROHM shall not be in any way responsible or liable for infringement of any intellectual property rights or other damages arising from use of such information or data.:
2. No license, expressly or implied, is granted hereby under any intellectual property rights or other rights of ROHM or any third parties with respect to the information contained in this document.

### Other Precaution

1. This document may not be reprinted or reproduced, in whole or in part, without prior written consent of ROHM.
2. The Products may not be disassembled, converted, modified, reproduced or otherwise changed without prior written consent of ROHM.
3. In no event shall you use in any way whatsoever the Products and the related technical information contained in the Products or this document for any military purposes, including but not limited to, the development of mass-destruction weapons.
4. The proper names of companies or products described in this document are trademarks or registered trademarks of ROHM, its affiliated companies or third parties.

**General Precaution**







1. Before you use our Products, you are requested to carefully read this document and fully understand its contents. ROHM shall not be in any way responsible or liable for failure, malfunction or accident arising from the use of any ROHM's Products against warning, caution or note contained in this document.
2. All information contained in this document is current as of the issuing date and subject to change without any prior notice. Before purchasing or using ROHM's Products, please confirm the latest information with a ROHM sales representative.
3. The information contained in this document is provided on an "as is" basis and ROHM does not warrant that all information contained in this document is accurate and/or error-free. ROHM shall not be in any way responsible or liable for any damages, expenses or losses incurred by you or third parties resulting from inaccuracy or errors of or concerning such information.

## Looking for pricing, stock, or lifecycle information?

Click below to explore more details on WIN SOURCE:

-  [View BA10358FJ-GE2 on WIN SOURCE](#)
-  [Rohm Semiconductor](#) Information

## Optimize Your Supply Chain with WIN SOURCE Solutions

-  Global Sourcing Solution
-  Obsolete Management
-  Cost Control Management
-  Shortage Management
-  Alternative Solution
-  Excess Inventory Management