



**THE DATASHEET OF  
AD5248BRMZ10-RL7**



## FEATURES

- 2-channel, 256-position potentiometers
- End-to-end resistance: 2.5 k $\Omega$ , 10 k $\Omega$ , 50 k $\Omega$ , and 100 k $\Omega$
- Compact 10-lead MSOP (3 mm  $\times$  4.9 mm) package
- Fast settling time:  $t_s = 5 \mu\text{s}$  typical on power-up
- Full read/write of wiper register
- Power-on preset to midscale
- Extra package address decode pins: AD0 and AD1 (**AD5248** only)
- Computer software replaces microcontroller in factory programming applications
- Single supply: 2.7 V to 5.5 V
- Low temperature coefficient: 35 ppm/ $^{\circ}\text{C}$
- Low power:  $I_{DD} = 6 \mu\text{A}$  maximum
- Wide operating temperature:  $-40^{\circ}\text{C}$  to  $+125^{\circ}\text{C}$
- Evaluation board available

## APPLICATIONS

- Systems calibrations
- Electronics level settings
- Mechanical trimmers replacement in new designs
- Permanent factory printed circuit board (PCB) setting
- Transducer adjustment of pressure, temperature, position, chemical, and optical sensors
- RF amplifier biasing
- Gain control and offset adjustment

## GENERAL DESCRIPTION

The **AD5243** and **AD5248** provide a compact 3 mm  $\times$  4.9 mm packaged solution for dual, 256-position adjustment applications. The **AD5243** performs the same electronic adjustment function as a 3-terminal mechanical potentiometer, and the **AD5248** performs the same adjustment function as a 2-terminal variable resistor. Available in four end-to-end resistance values (2.5 k $\Omega$ , 10 k $\Omega$ , 50 k $\Omega$ , and 100 k $\Omega$ ), these low temperature coefficient devices are ideal for high accuracy and stability-variable resistance adjustments. The wiper settings are controllable through the I<sup>2</sup>C-compatible digital interface. The **AD5248** has extra package address decode pins, AD0 and AD1, allowing multiple parts to share the same I<sup>2</sup>C, 2-wire bus on a PCB. The resistance between the wiper and either endpoint of the fixed resistor varies linearly with respect to the digital code transferred

## FUNCTIONAL BLOCK DIAGRAMS

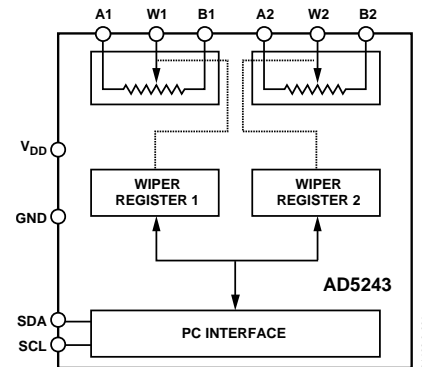

Figure 1. AD5243

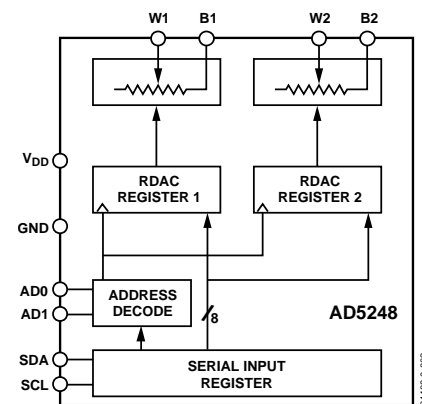

Figure 2. AD5248

into the RDAC latch. (The terms digital potentiometer, VR, and RDAC are used interchangeably.)

Operating from a 2.7 V to 5.5 V power supply and consuming less than 6  $\mu\text{A}$  allows the **AD5243/AD5248** to be used in portable battery-operated applications.

For applications that program the **AD5243/AD5248** at the factory, Analog Devices, Inc., offers device programming software running on Windows<sup>®</sup> NT/2000/XP operating systems. This software effectively replaces the need for external I<sup>2</sup>C controllers, which in turn enhances the time to market of systems. An **AD5243/AD5248** evaluation kit and software are available. The kit includes a cable and instruction manual.

## TABLE OF CONTENTS

|  |   |  |    |
|--|---|--|----|
| Features .....   | 1 | Test Circuits.....                                   | 12 |
| Applications.....  | 1 | Theory of Operation .....                            | 13 |
| Functional Block Diagrams.....   | 1 | Programming the Variable Resistor and Voltage.....   | 13 |
| General Description .....  | 1 | Programming the Potentiometer Divider.....           | 14 |
| Revision History .....   | 2 | ESD Protection .....                                 | 14 |
| Specifications.....  | 3 | Terminal Voltage Operating Range .....               | 14 |
| Electrical Characteristics: 2.5 k $\Omega$ Version.....                        | 3 | Power-Up Sequence .....                              | 14 |
| Electrical Characteristics: 10 k $\Omega$ , 50 k $\Omega$ , and 100 k $\Omega$ |   | Layout and Power Supply Bypassing .....              | 14 |
| Versions.....  | 4 | Constant Bias to Retain Resistance Setting.....      | 15 |
| Timing Characteristics: All Versions .....                                     | 5 | I <sup>2</sup> C Interface .....                     | 16 |
| Absolute Maximum Ratings.....  | 6 | I <sup>2</sup> C Compatible, 2-Wire Serial Bus ..... | 16 |
| ESD Caution.....   | 6 | I <sup>2</sup> C Controller Programming.....         | 18 |
| Pin Configurations and Function Descriptions .....                             | 7 | Outline Dimensions .....                             | 19 |
| Typical Performance Characteristics .....                                      | 8 | Ordering Guide .....                                 | 19 |

## REVISION HISTORY

### 4/16—Rev. B to Rev. C

|   |    |
|---|----|
| Changes to Applications Section and General Description |    |
| Section.....  | 1  |
| Changed Digital Inputs and Outputs Parameter to Digital |    |
| Inputs Parameter, Table 1 .....                         | 3  |
| Changed Digital Inputs and Outputs Parameter to Digital |    |
| Inputs Parameter, Table 2 .....                         | 4  |
| Changes to Ordering Guide .....                         | 19 |

### 4/12—Rev. A to Rev. B

|  |    |
|--|----|
| Changes to Rheostat Operation Section, Table 7, and        |    |
| Table 8 .....  | 13 |
| Changes to Voltage Output Operation Section .....          | 14 |
| Deleted Evaluation Board Section and Figure 45, Renumbered |    |
| Sequentially .....   | 15 |
| Changes to Table 13.....                                   | 17 |
| Updated Outline Dimensions .....                           | 19 |
| Changes to Ordering Guide .....                            | 19 |

### 4/09—Rev. 0 to Rev. A

|   |    |
|---|----|
| Changes to DC Characteristics—Rheostat Mode Parameter and   |    |
| to DC Characteristics—Potentiometer Divider Mode Parameter, |    |
| Table 1 .....   | 3  |
| Moved Figure 3 .....  | 5  |
| Updated Outline Dimensions .....                            | 19 |
| Changes to Ordering Guide .....                             | 19 |

### 1/04—Revision 0: Initial Version

## SPECIFICATIONS

## ELECTRICAL CHARACTERISTICS: 2.5 kΩ VERSION

$V_{DD} = 5\text{ V} \pm 10\%$ , or  $3\text{ V} \pm 10\%$ ;  $V_A = V_{DD}$ ;  $V_B = 0\text{ V}$ ;  $-40^\circ\text{C} < T_A < +125^\circ\text{C}$ ; unless otherwise noted.

Table 1.

| Parameter  | Symbol                            | Conditions   | Min  | Typ <sup>1</sup> | Max      | Unit   |
|--|-----------------------------------|--|------|------------------|----------|--------|
| <b>DC CHARACTERISTICS—RHEOSTAT MODE</b>                          |                                   |  |      |                  |          |        |
| Resistor Differential Nonlinearity <sup>2</sup>                  | R-DNL                             | $R_{WB}, V_A = \text{no connect}$                                      | -2   | ±0.1             | +2       | LSB    |
| Resistor Integral Nonlinearity <sup>2</sup>                      | R-INL                             | $R_{WB}, V_A = \text{no connect}$                                      | -14  | ±2               | +14      | LSB    |
| Nominal Resistor Tolerance <sup>3</sup>                          | $\Delta R_{AB}$                   | $T_A = 25^\circ\text{C}$   | -20  |                  | +55      | %      |
| Resistance Temperature Coefficient                               | $(\Delta R_{AB}/R_{AB})/\Delta T$ | $V_{AB} = V_{DD}$ , wiper = no connect                                 |      | 35               |          | ppm/°C |
| Wiper Resistance   | $R_{WB}$                          | Code = 0x00, $V_{DD} = 5\text{ V}$                                     |      | 160              | 200      | Ω      |
| <b>DC CHARACTERISTICS—POTENTIOMETER DIVIDER MODE<sup>4</sup></b> |                                   |  |      |                  |          |        |
| Differential Nonlinearity <sup>5</sup>                           | DNL                               |  | -1.5 | ±0.1             | +1.5     | LSB    |
| Integral Nonlinearity <sup>5</sup>                               | INL                               |  | -2   | ±0.6             | +2       | LSB    |
| Voltage Divider Temperature Coefficient                          | $(\Delta V_W/V_W)/\Delta T$       | Code = 0x80  |      | 15               |          | ppm/°C |
| Full-Scale Error   | $V_{WFSE}$                        | Code = 0xFF  | -14  | -5.5             | 0        | LSB    |
| Zero-Scale Error   | $V_{WZSE}$                        | Code = 0x00  | 0    | 4.5              | 12       | LSB    |
| <b>RESISTOR TERMINALS</b>  |                                   |  |      |                  |          |        |
| Voltage Range <sup>6</sup>                                       | $V_A, V_B, V_W$                   |  | GND  |                  | $V_{DD}$ | V      |
| Capacitance A, B <sup>7</sup>                                    | $C_A, C_B$                        | $f = 1\text{ MHz}$ , measured to GND, code = 0x80                      |      | 45               |          | pF     |
| Capacitance W <sup>7</sup>                                       | $C_W$                             | $f = 1\text{ MHz}$ , measured to GND, code = 0x80                      |      | 60               |          | pF     |
| Shutdown Supply Current <sup>8</sup>                             | $I_{A\_SD}$                       | $V_{DD} = 5.5\text{ V}$  |      | 0.01             | 1        | μA     |
| Common-Mode Leakage  | $I_{CM}$                          | $V_A = V_B = V_{DD}/2$   |      | 1                |          | nA     |
| <b>DIGITAL INPUTS</b>  |                                   |  |      |                  |          |        |
| Input Logic High   | $V_{IH}$                          | $V_{DD} = 5\text{ V}$  | 2.4  |                  |          | V      |
| Input Logic Low  | $V_{IL}$                          | $V_{DD} = 5\text{ V}$  |      |                  | 0.8      | V      |
| Input Logic High   | $V_{IH}$                          | $V_{DD} = 3\text{ V}$  | 2.1  |                  |          | V      |
| Input Logic Low  | $V_{IL}$                          | $V_{DD} = 3\text{ V}$  |      |                  | 0.6      | V      |
| Input Current  | $I_{IL}$                          | $V_{IN} = 0\text{ V}$ or $5\text{ V}$                                  |      |                  | ±1       | μA     |
| Input Capacitance <sup>7</sup>                                   | $C_{IL}$                          |  |      | 5                |          | pF     |
| <b>POWER SUPPLIES</b>  |                                   |  |      |                  |          |        |
| Power Supply Range   | $V_{DD\text{ RANGE}}$             |  | 2.7  |                  | 5.5      | V      |
| Supply Current   | $I_{DD}$                          | $V_{IH} = 5\text{ V}$ or $V_{IL} = 0\text{ V}$                         |      | 3.5              | 6        | μA     |
| Power Dissipation <sup>9</sup>                                   | $P_{DISS}$                        | $V_{IH} = 5\text{ V}$ or $V_{IL} = 0\text{ V}$ , $V_{DD} = 5\text{ V}$ |      |                  | 30       | μW     |
| Power Supply Sensitivity   | PSS                               | $V_{DD} = 5\text{ V} \pm 10\%$ , code = midscale                       |      | ±0.02            | ±0.08    | %/%    |
| <b>DYNAMIC CHARACTERISTICS<sup>10</sup></b>                      |                                   |  |      |                  |          |        |
| Bandwidth, -3 dB   | BW                                | Code = 0x80  |      | 4.8              |          | MHz    |
| Total Harmonic Distortion  | THD <sub>W</sub>                  | $V_A = 1\text{ V rms}$ , $V_B = 0\text{ V}$ , $f = 1\text{ kHz}$       |      | 0.1              |          | %      |
| $V_W$ Settling Time  | $t_S$                             | $V_A = 5\text{ V}$ , $V_B = 0\text{ V}$ , ±1 LSB error band            |      | 1                |          | μs     |
| Resistor Noise Voltage Density                                   | $e_{N\_WB}$                       | $R_{WB} = 1.25\text{ k}\Omega$ , $R_S = 0$                             |      | 3.2              |          | nV/√Hz |

<sup>1</sup> Typical specifications represent average readings at  $25^\circ\text{C}$  and  $V_{DD} = 5\text{ V}$ .

<sup>2</sup> Resistor position nonlinearity error, R-INL, is the deviation from an ideal value measured between the maximum resistance and the minimum resistance wiper positions. R-DNL measures the relative step change from the ideal between successive tap positions. Parts are guaranteed monotonic.

<sup>3</sup>  $V_A = V_{DD}$ ,  $V_B = 0\text{ V}$ , wiper ( $V_W$ ) = no connect.

<sup>4</sup> Specifications apply to all VRs.

<sup>5</sup> INL and DNL are measured at  $V_W$  with the RDAC configured as a potentiometer divider similar to a voltage output digital-to-analog converter (DAC).  $V_A = V_{DD}$  and  $V_B = 0\text{ V}$ . DNL specification limits of ±1 LSB maximum are guaranteed monotonic operating conditions.

<sup>6</sup> Resistor Terminal A, Resistor Terminal B, and Resistor Terminal W have no limitations on polarity with respect to each other.

<sup>7</sup> Guaranteed by design, but not subject to production test.

<sup>8</sup> Measured at the A terminal. The A terminal is open circuited in shutdown mode.

<sup>9</sup>  $P_{DISS}$  is calculated from  $(I_{DD} \times V_{DD})$ . CMOS logic level inputs result in minimum power dissipation.

<sup>10</sup> All dynamic characteristics use  $V_{DD} = 5\text{ V}$ .

**ELECTRICAL CHARACTERISTICS: 10 kΩ, 50 kΩ, AND 100 kΩ VERSIONS**

$V_{DD} = 5\text{ V} \pm 10\%$ , or  $3\text{ V} \pm 10\%$ ;  $V_A = V_{DD}$ ;  $V_B = 0\text{ V}$ ;  $-40^\circ\text{C} < T_A < 125^\circ\text{C}$ ; unless otherwise noted.

**Table 2.**

| Parameter  | Symbol                            | Conditions  | Min  | Typ <sup>1</sup> | Max      | Unit   |
|--|-----------------------------------|---|------|------------------|----------|--------|
| <b>DC CHARACTERISTICS—RHEOSTAT MODE</b>                          |                                   |   |      |                  |          |        |
| Resistor Differential Nonlinearity <sup>2</sup>                  | R-DNL                             | $R_{WB}, V_A = \text{no connect}$   | -1   | ±0.1             | +1       | LSB    |
| Resistor Integral Nonlinearity <sup>2</sup>                      | R-INL                             | $R_{WB}, V_A = \text{no connect}$   | -2.5 | ±0.25            | +2.5     | LSB    |
| Nominal Resistor Tolerance <sup>3</sup>                          | $\Delta R_{AB}$                   | $T_A = 25^\circ\text{C}$  | -20  |                  | +20      | %      |
| Resistance Temperature Coefficient                               | $(\Delta R_{AB}/R_{AB})/\Delta T$ | $V_{AB} = V_{DD}$ , wiper = no connect  |      | 35               |          | ppm/°C |
| Wiper Resistance   | $R_{WB}$                          | Code = 0x00, $V_{DD} = 5\text{ V}$  |      | 160              | 200      | Ω      |
| <b>DC CHARACTERISTICS—POTENTIOMETER DIVIDER MODE<sup>4</sup></b> |                                   |   |      |                  |          |        |
| Differential Nonlinearity <sup>5</sup>                           | DNL                               |   | -1   | ±0.1             | +1       | LSB    |
| Integral Nonlinearity <sup>5</sup>                               | INL                               |   | -1   | ±0.3             | +1       | LSB    |
| Voltage Divider Temperature Coefficient                          | $(\Delta V_W/V_W)/\Delta T$       | Code = 0x80   |      | 15               |          | ppm/°C |
| Full-Scale Error   | $V_{WFSE}$                        | Code = 0xFF   | -2.5 | -1               | 0        | LSB    |
| Zero-Scale Error   | $V_{WZSE}$                        | Code = 0x00   | 0    | 1                | 2.5      | LSB    |
| <b>RESISTOR TERMINALS</b>  |                                   |   |      |                  |          |        |
| Voltage Range <sup>6</sup>                                       | $V_A, V_B, V_W$                   |   | GND  |                  | $V_{DD}$ | V      |
| Capacitance A, B <sup>7</sup>                                    | $C_A, C_B$                        | $f = 1\text{ MHz}$ , measured to GND, code = 0x80   |      | 45               |          | pF     |
| Capacitance W <sup>7</sup>                                       | $C_W$                             | $f = 1\text{ MHz}$ , measured to GND, code = 0x80   |      | 60               |          | pF     |
| Shutdown Supply Current <sup>8</sup>                             | $I_{A\_SD}$                       | $V_{DD} = 5.5\text{ V}$   |      | 0.01             | 1        | μA     |
| Common-Mode Leakage  | $I_{CM}$                          | $V_A = V_B = V_{DD}/2$  |      | 1                |          | nA     |
| <b>DIGITAL INPUTS</b>  |                                   |   |      |                  |          |        |
| Input Logic High   | $V_{IH}$                          | $V_{DD} = 5\text{ V}$   | 2.4  |                  |          | V      |
| Input Logic Low  | $V_{IL}$                          | $V_{DD} = 5\text{ V}$   |      |                  | 0.8      | V      |
| Input Logic High   | $V_{IH}$                          | $V_{DD} = 3\text{ V}$   | 2.1  |                  |          | V      |
| Input Logic Low  | $V_{IL}$                          | $V_{DD} = 3\text{ V}$   |      |                  | 0.6      | V      |
| Input Current  | $I_{IL}$                          | $V_{IN} = 0\text{ V}$ or $5\text{ V}$   |      |                  | ±1       | μA     |
| Input Capacitance  | $C_{IL}$                          |   |      | 5                |          | pF     |
| <b>POWER SUPPLIES</b>  |                                   |   |      |                  |          |        |
| Power Supply Range   | $V_{DD\text{ RANGE}}$             |   | 2.7  |                  | 5.5      | V      |
| Supply Current   | $I_{DD}$                          | $V_{IH} = 5\text{ V}$ or $V_{IL} = 0\text{ V}$  |      | 3.5              | 6        | μA     |
| Power Dissipation  | $P_{DISS}$                        | $V_{IH} = 5\text{ V}$ or $V_{IL} = 0\text{ V}$ , $V_{DD} = 5\text{ V}$                          |      |                  | 30       | μW     |
| Power Supply Sensitivity   | PSS                               | $V_{DD} = 5\text{ V} \pm 10\%$ , code = midscale  |      | ±0.02            | ±0.08    | %/%    |
| <b>DYNAMIC CHARACTERISTICS</b>                                   |                                   |   |      |                  |          |        |
| Bandwidth, -3 dB   | BW                                | $R_{AB} = 10\text{ k}\Omega/50\text{ k}\Omega/100\text{ k}\Omega$ , code = 0x80                 |      | 600/100/40       |          | kHz    |
| Total Harmonic Distortion  | THD <sub>w</sub>                  | $V_A = 1\text{ V rms}$ , $V_B = 0\text{ V}$ , $f = 1\text{ kHz}$ , $R_{AB} = 10\text{ k}\Omega$ |      | 0.1              |          | %      |
| $V_W$ Settling Time  | $t_s$                             | $V_A = 5\text{ V}$ , $V_B = 0\text{ V}$ , ±1 LSB error band                                     |      | 2                |          | μs     |
| Resistor Noise Voltage Density                                   | $e_{N\_WB}$                       | $R_{WB} = 5\text{ k}\Omega$ , $R_S = 0$   |      | 9                |          | nV/√Hz |

<sup>1</sup> Typical specifications represent average readings at  $25^\circ\text{C}$  and  $V_{DD} = 5\text{ V}$ .

<sup>2</sup> Resistor position nonlinearity error, R-INL, is the deviation from an ideal value measured between the maximum resistance and the minimum resistance wiper positions. R-DNL measures the relative step change from the ideal between successive tap positions. Parts are guaranteed monotonic.

<sup>3</sup>  $V_A = V_{DD}$ ,  $V_B = 0\text{ V}$ , wiper ( $V_W$ ) = no connect.

<sup>4</sup> Specifications apply to all VRs.

<sup>5</sup> INL and DNL are measured at  $V_W$  with the RDAC configured as a potentiometer divider similar to a voltage output DAC.  $V_A = V_{DD}$  and  $V_B = 0\text{ V}$ . DNL specification limits of ±1 LSB maximum are guaranteed monotonic operating conditions.

<sup>6</sup> Resistor Terminal A, Resistor Terminal B, and Resistor Terminal W have no limitations on polarity with respect to each other.

<sup>7</sup> Guaranteed by design, but not subject to production test.

<sup>8</sup> Measured at the A terminal. The A terminal is open circuited in shutdown mode.



## ABSOLUTE MAXIMUM RATINGS

$T_A = 25^\circ\text{C}$ , unless otherwise noted.

Table 4.

| Parameter   | Rating                                      |
|---|---|
| $V_{DD}$ to GND   | -0.3 V to +7 V                              |
| $V_A, V_B, V_W$ to GND  | $V_{DD}$                                    |
| Terminal Current, $A_x$ to $B_x$ , $A_x$ to $W_x$ , $B_x$ to $W_x$ <sup>1</sup> |   |
| Pulsed  | $\pm 20$ mA                                 |
| Continuous  | $\pm 5$ mA                                  |
| Digital Inputs and Output Voltage to GND  | 0 V to 7 V                                  |
| Operating Temperature Range   | $-40^\circ\text{C}$ to $+125^\circ\text{C}$ |
| Maximum Junction Temperature ( $T_{JMAX}$ )                                     | $150^\circ\text{C}$                         |
| Storage Temperature   | $-65^\circ\text{C}$ to $+150^\circ\text{C}$ |
| Lead Temperature (Soldering, 10 sec)  | $300^\circ\text{C}$                         |
| Thermal Resistance, $\theta_{JA}$ for 10-Lead MSOP <sup>2</sup>                 | $230^\circ\text{C/W}$                       |

<sup>1</sup>The maximum terminal current is bound by the maximum current handling of the switches, the maximum power dissipation of the package, and the maximum applied voltage across any two of the A, B, and W terminals at a given resistance.

<sup>2</sup>The package power dissipation is  $(T_{JMAX} - T_A)/\theta_{JA}$ .

Stresses at or above those listed under Absolute Maximum Ratings may cause permanent damage to the product. This is a stress rating only; functional operation of the product at these or any other conditions above those indicated in the operational section of this specification is not implied. Operation beyond the maximum operating conditions for extended periods may affect product reliability.

### ESD CAUTION



**ESD (electrostatic discharge) sensitive device.** Charged devices and circuit boards can discharge without detection. Although this product features patented or proprietary protection circuitry, damage may occur on devices subjected to high energy ESD. Therefore, proper ESD precautions should be taken to avoid performance degradation or loss of functionality.

## PIN CONFIGURATIONS AND FUNCTION DESCRIPTIONS

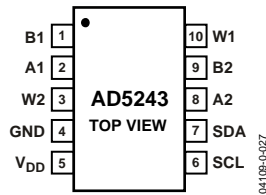

Figure 4. AD5243 Pin Configuration

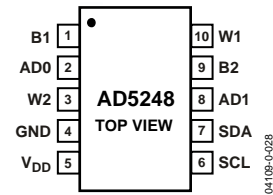

Figure 5. AD5248 Pin Configuration

Table 5. AD5243 Pin Function Descriptions

| Pin No. | Mnemonic        | Description                                  |
|---------|-----------------|--|
| 1       | B1              | B1 Terminal.                                 |
| 2       | A1              | A1 Terminal.                                 |
| 3       | W2              | W2 Terminal.                                 |
| 4       | GND             | Digital Ground.                              |
| 5       | V <sub>DD</sub> | Positive Power Supply.                       |
| 6       | SCL             | Serial Clock Input. Positive-edge triggered. |
| 7       | SDA             | Serial Data Input/Output.                    |
| 8       | A2              | A2 Terminal.                                 |
| 9       | B2              | B2 Terminal.                                 |
| 10      | W1              | W1 Terminal.                                 |

Table 6. AD5248 Pin Function Descriptions

| Pin No. | Mnemonic        | Description   |
|---------|-----------------|---|
| 1       | B1              | B1 Terminal.  |
| 2       | AD0             | Programmable Address Bit 0 for Multiple Package Decoding. |
| 3       | W2              | W2 Terminal.  |
| 4       | GND             | Digital Ground.   |
| 5       | V <sub>DD</sub> | Positive Power Supply.                                    |
| 6       | SCL             | Serial Clock Input. Positive-edge triggered.              |
| 7       | SDA             | Serial Data Input/Output.                                 |
| 8       | AD1             | Programmable Address Bit 1 for Multiple Package Decoding. |
| 9       | B2              | B2 Terminal.  |
| 10      | W1              | W1 Terminal.  |

TYPICAL PERFORMANCE CHARACTERISTICS

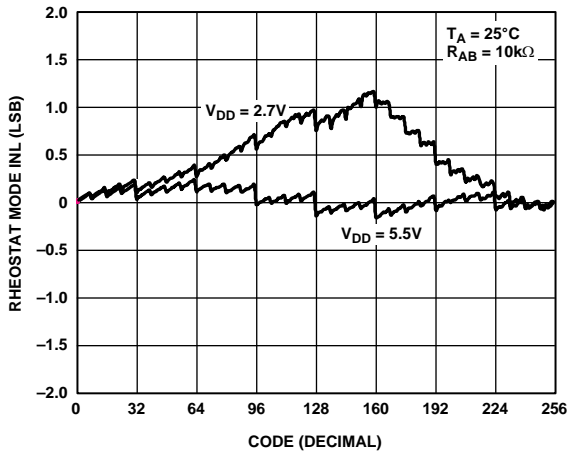

Figure 6. R-INL vs. Code vs. Supply Voltages

04109-0-030

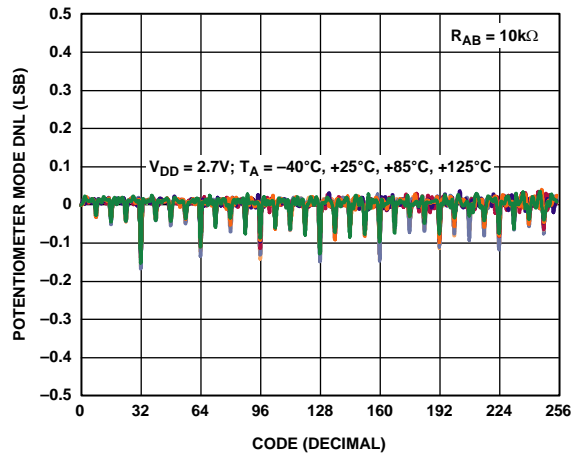

Figure 9. DNL vs. Code vs. Temperature

04109-0-033

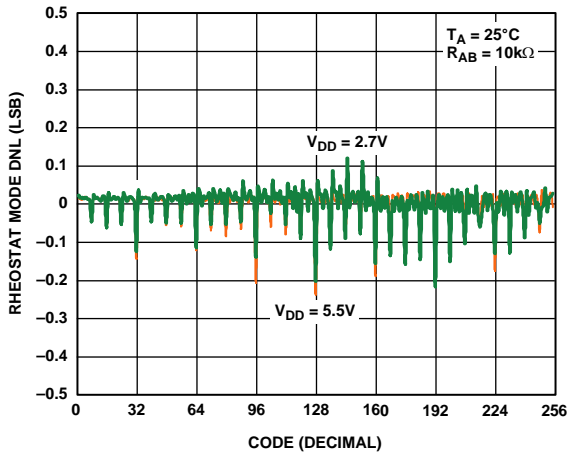

Figure 7. R-DNL vs. Code vs. Supply Voltages

04109-0-031

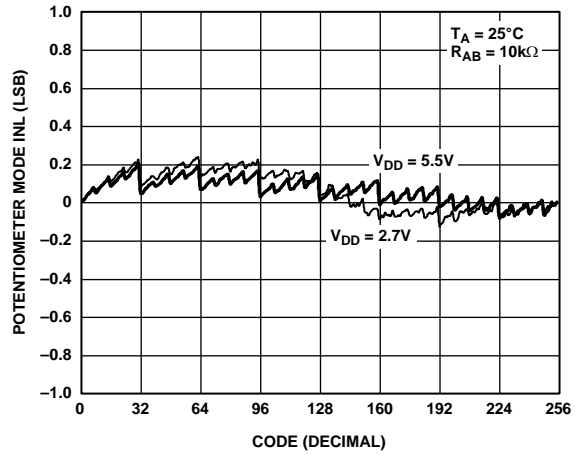

Figure 10. INL vs. Code vs. Supply Voltages

04109-0-034

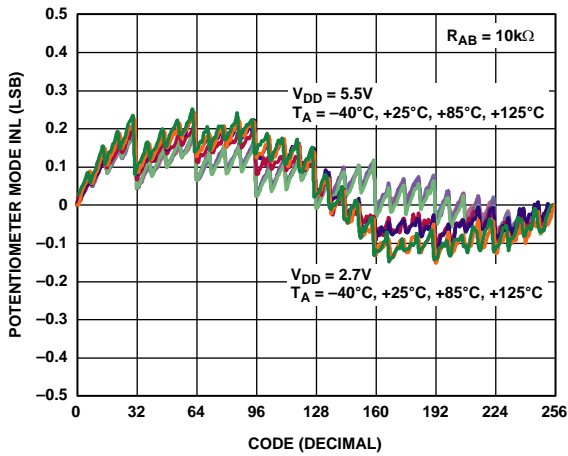

Figure 8. INL vs. Code vs. Temperature

04109-0-032

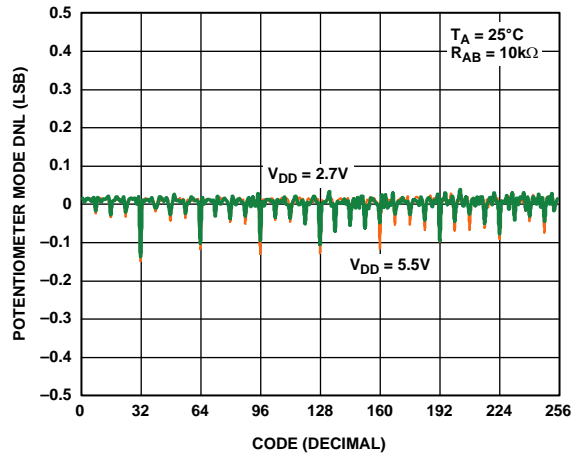

Figure 11. DNL vs. Code vs. Supply Voltages

04109-0-035

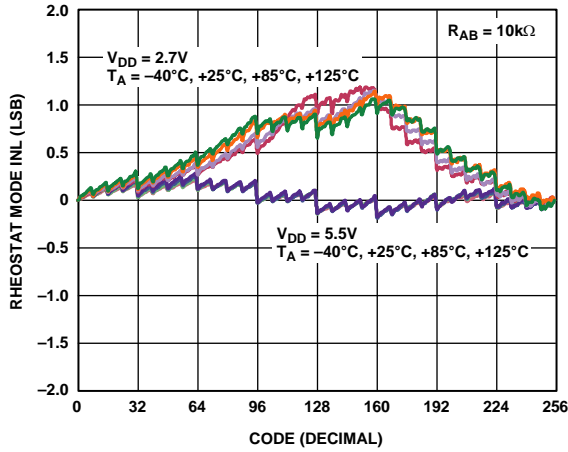

Figure 12. R-INL vs. Code vs. Temperature

04109-0-035

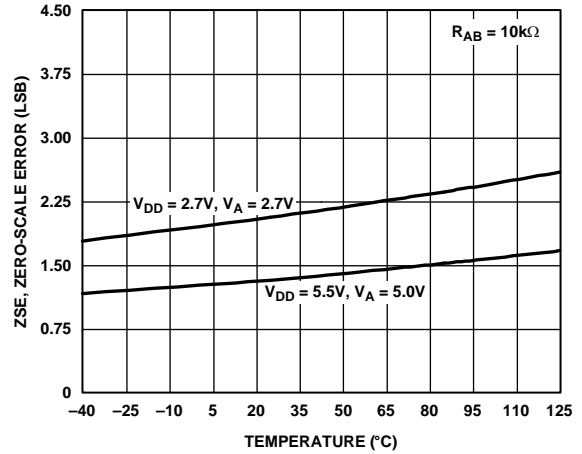

Figure 15. Zero-Scale Error vs. Temperature

04109-0-038

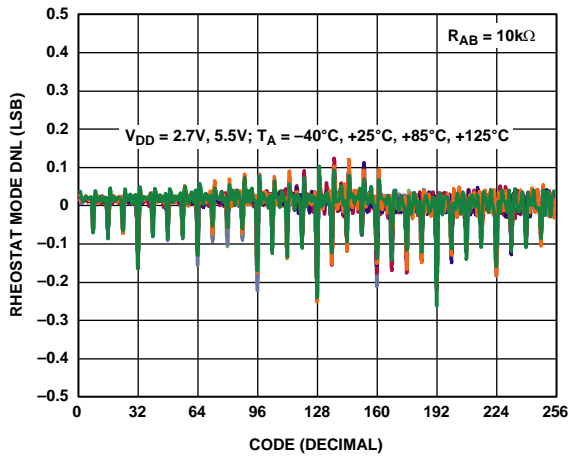

Figure 13. R-DNL vs. Code vs. Temperature

04109-0-037

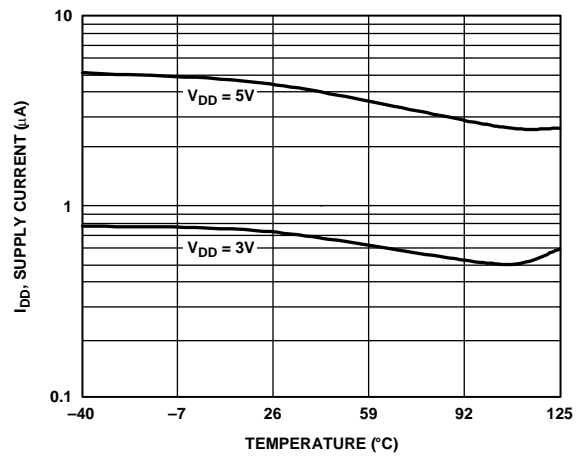

Figure 16. Supply Current vs. Temperature

04109-0-040

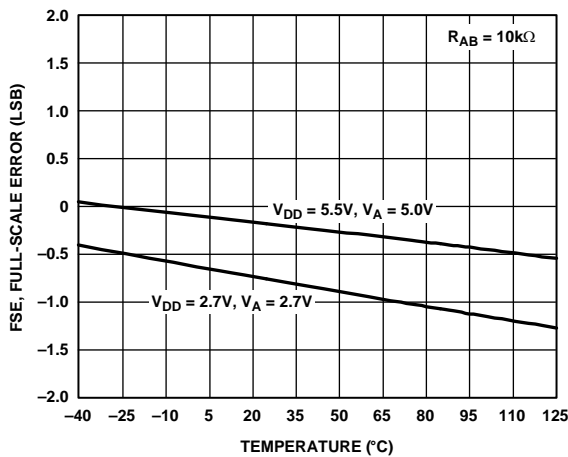

Figure 14. Full-Scale Error vs. Temperature

04109-0-036

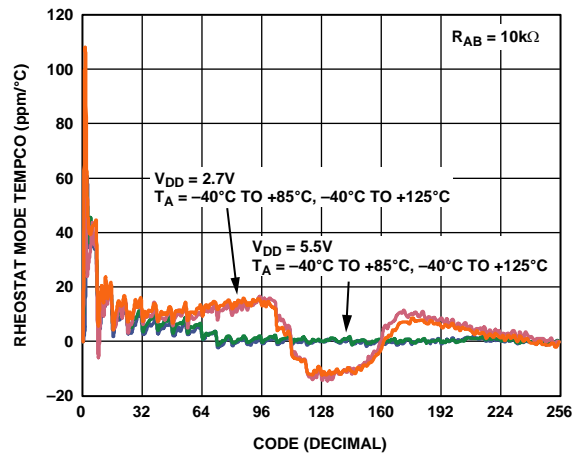

Figure 17. Rheostat Mode Tempco  $\Delta R_{WB}/\Delta T$  vs. Code

04109-0-041

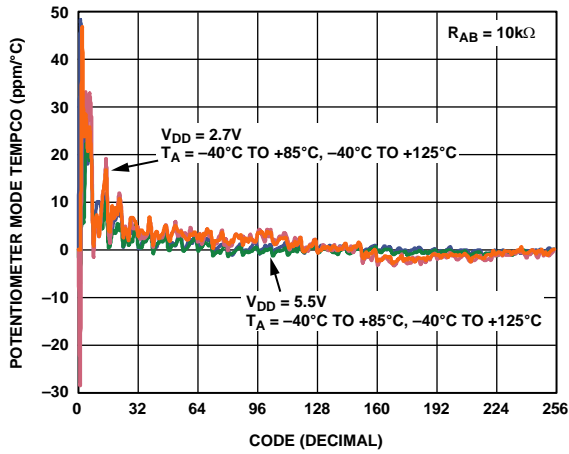

Figure 18. Potentiometer Mode Tempco  $\Delta V_{WB}/\Delta T$  vs. Code

04109-0-042

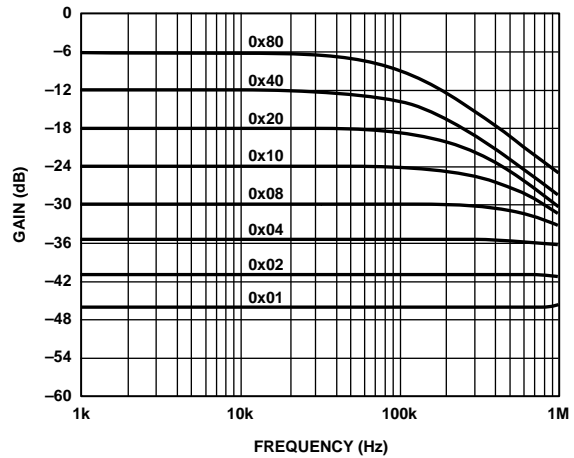

Figure 21. Gain vs. Frequency vs. Code,  $R_{AB} = 50\text{ k}\Omega$

04109-0-045

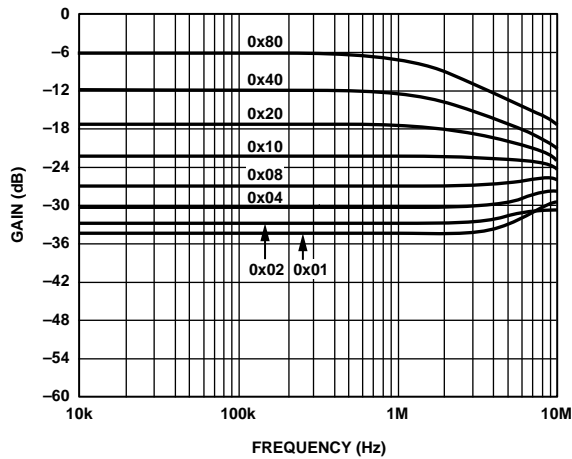

Figure 19. Gain vs. Frequency vs. Code,  $R_{AB} = 2.5\text{ k}\Omega$

04109-0-043

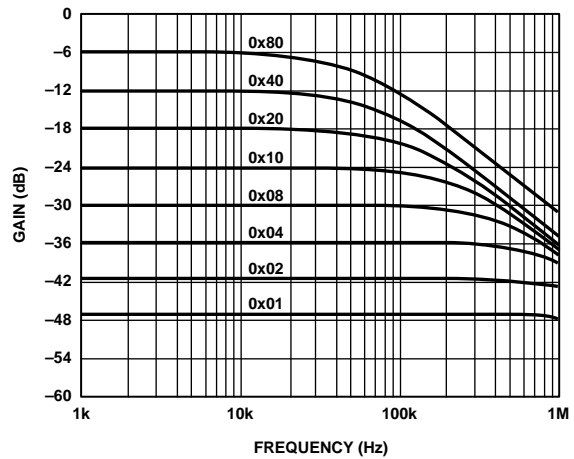

Figure 22. Gain vs. Frequency vs. Code,  $R_{AB} = 100\text{ k}\Omega$

04109-0-046

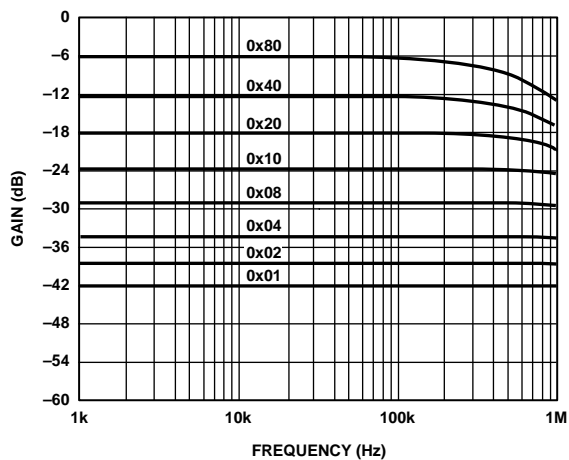

Figure 20. Gain vs. Frequency vs. Code,  $R_{AB} = 10\text{ k}\Omega$

04109-0-044

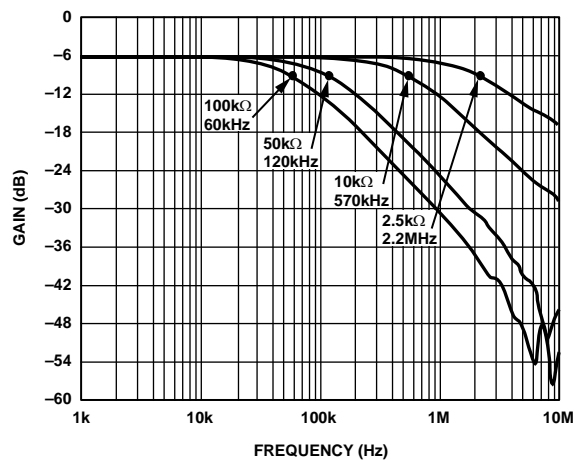

Figure 23.  $-3\text{ dB}$  Bandwidth at Code = 0x80

04109-0-047

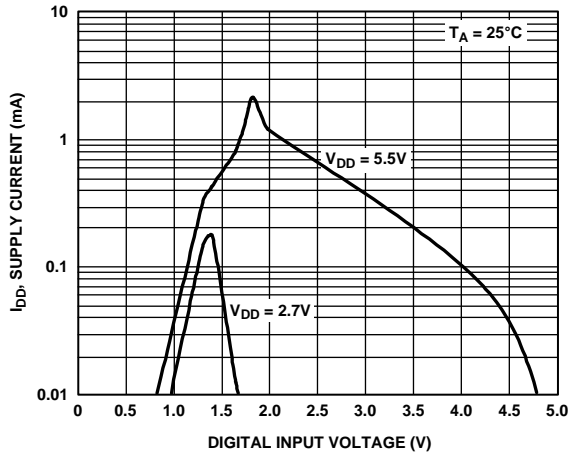

Figure 24. Supply Current vs. Digital Input Voltage

04109-0-062

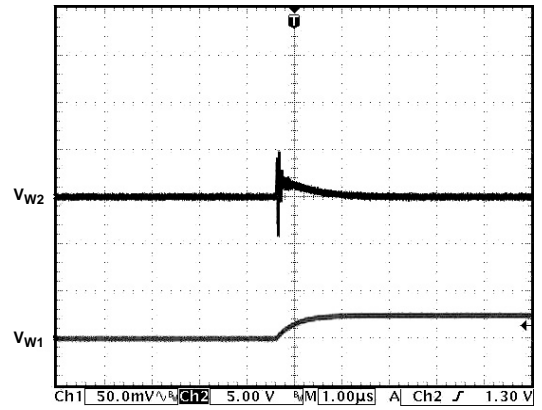

Figure 27. Analog Crosstalk

04109-0-051

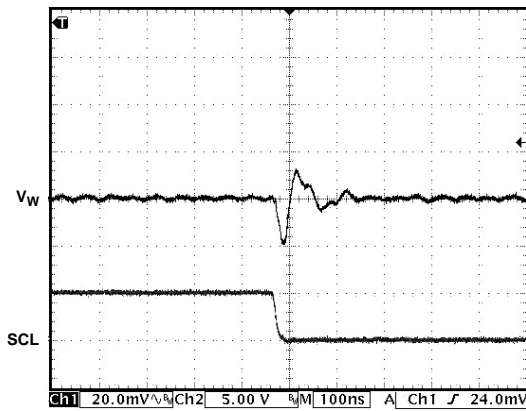

Figure 25. Digital Feedthrough

04109-0-048

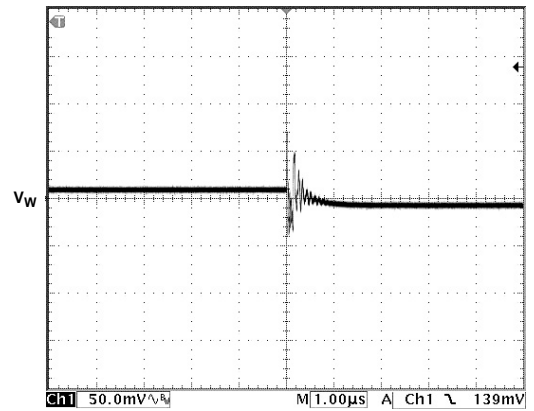

Figure 28. Midscale Glitch, Code 0x80 to Code 0x7F

04109-0-053

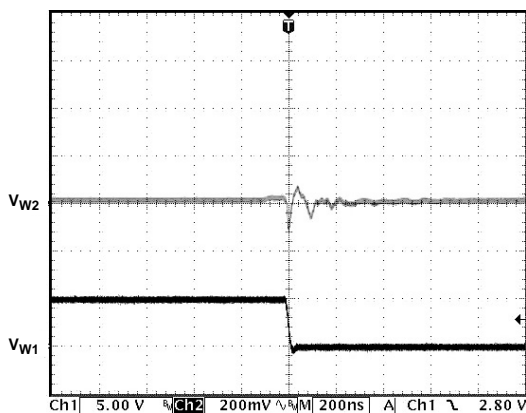

Figure 26. Digital Crosstalk

04109-0-049

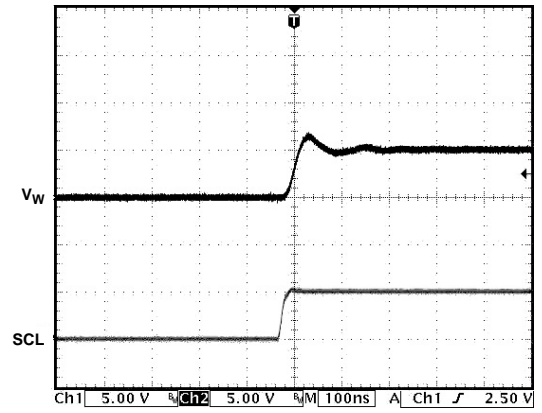

Figure 29. Large-Signal Settling Time

04109-0-050

TEST CIRCUITS

Figure 30 through Figure 36 illustrate the test circuits that define the test conditions used in the product specification tables (see Table 1 and Table 2).

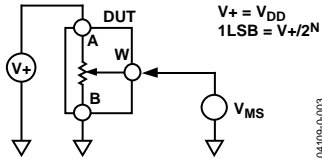

Figure 30. Test Circuit for Potentiometer Divider Nonlinearity Error (INL, DNL)

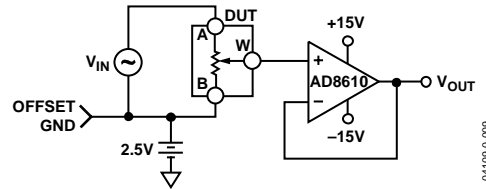

Figure 34. Test Circuit for Gain vs. Frequency

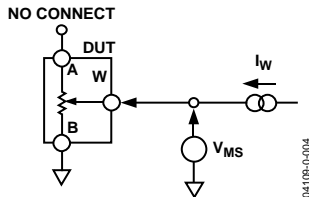

Figure 31. Test Circuit for Resistor Position Nonlinearity Error (Rheostat Operation: R-INL, R-DNL)

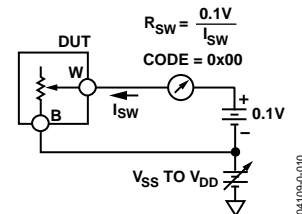

Figure 35. Test Circuit for Incremental On Resistance

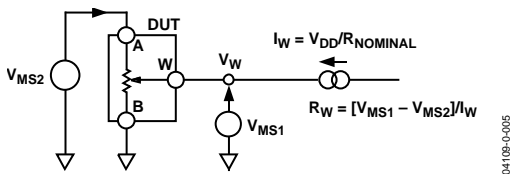

Figure 32. Test Circuit for Wiper Resistance

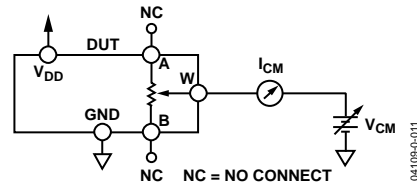

Figure 36. Test Circuit for Common-Mode Leakage Current

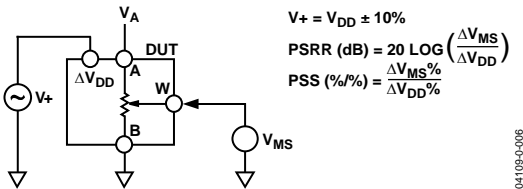

Figure 33. Test Circuit for Power Supply Sensitivity (PSS, PSSR)

## THEORY OF OPERATION

The AD5243/AD5248 are 256-position, digitally controlled variable resistor (VR) devices.

An internal power-on preset places the wiper at midscale during power-on, which simplifies the fault condition recovery at power-up.

### PROGRAMMING THE VARIABLE RESISTOR AND VOLTAGE

#### Rheostat Operation

The nominal resistance of the RDAC between Terminal A and Terminal B is available in 2.5 kΩ, 10 kΩ, 50 kΩ, and 100 kΩ. The nominal resistance ( $R_{AB}$ ) of the VR has 256 contact points accessed by the wiper terminal and the B terminal contact. The 8-bit data in the RDAC latch is decoded to select one of the 256 possible settings.

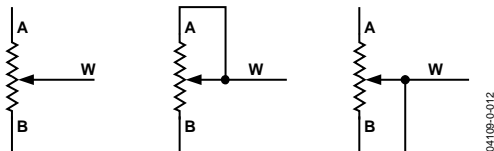

Figure 37. Rheostat Mode Configuration

Assuming that a 10 kΩ part is used, the first connection of the wiper starts at the B terminal for Data 0x00. Because there is a 160 Ω wiper contact resistance, such a connection yields a minimum of 320 Ω ( $2 \times 160 \Omega$ ) resistance between Terminal W and Terminal B. The second connection is the first tap point, which corresponds to 359 Ω ( $R_{WB} = R_{AB}/256 + 2 \times R_W = 39 \Omega + 2 \times 160 \Omega$ ) for Data 0x01. The third connection is the next tap point, representing 398 Ω ( $2 \times 39 \Omega + 2 \times 160 \Omega$ ) for Data 0x02, and so on. Each LSB data value increase moves the wiper up the resistor ladder until the last tap point is reached at 10,281 Ω ( $R_{AB} + 2 \times R_W$ ).

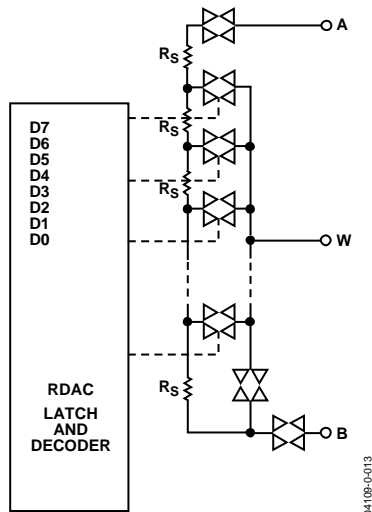

Figure 38. AD5243 Equivalent RDAC Circuit

The general equation determining the digitally programmed output resistance between W and B is

$$R_{WB}(D) = \frac{D}{256} \times R_{AB} + 2 \times R_W \quad (1)$$

where:

$D$  is the decimal equivalent of the binary code loaded in the 8-bit RDAC register.

$R_{AB}$  is the end-to-end resistance.

$R_W$  is the wiper resistance contributed by the on resistance of the internal switch.

In summary, if  $R_{AB}$  is 10 kΩ and the A terminal is open circuited, the following output resistance,  $R_{WB}$ , is set for the indicated RDAC latch codes.

Table 7. Codes and Corresponding  $R_{WB}$  Resistance

| D (Dec) | $R_{WB}$ (Ω) | Output State   |
|---------|--------------|--|
| 255     | 10,281       | Full scale ( $R_{AB} - 1 \text{ LSB} + 2 \times R_W$ ) |
| 128     | 5380         | Midscale   |
| 1       | 359          | 1 LSB + $2 \times R_W$                                 |
| 0       | 320          | Zero scale (wiper contact resistance)                  |

Note that in the zero-scale condition, a finite wiper resistance of 320 Ω is present. Care should be taken to limit the current flow between W and B in this state to a maximum pulse current of no more than 20 mA. Otherwise, degradation or possible destruction of the internal switch contact may occur.

Similar to the mechanical potentiometer, the resistance of the RDAC between Wiper W and Terminal A also produces a digitally controlled complementary resistance,  $R_{WA}$ . When these terminals are used, the B terminal can be opened. Setting the resistance value for  $R_{WA}$  starts at a maximum value of resistance and decreases as the data loaded in the latch increases in value. The general equation for this operation is

$$R_{WA}(D) = \frac{256 - D}{256} \times R_{AB} + 2 \times R_W \quad (2)$$

When  $R_{AB}$  is 10 kΩ and the B terminal is open circuited, the output resistance,  $R_{WA}$ , is set according to the RDAC latch codes, as listed in Table 8.

Table 8. Codes and Corresponding  $R_{WA}$  Resistance

| D (Dec) | $R_{WA}$ (Ω) | Output State           |
|---------|--------------|------------------------|
| 255     | 359          | Full scale             |
| 128     | 5320         | Midscale               |
| 1       | 10,280       | 1 LSB + $2 \times R_W$ |
| 0       | 10,320       | Zero scale             |

Typical device-to-device matching is process-lot dependent and may vary by up to ±30%. Because the resistance element is processed in thin-film technology, the change in  $R_{AB}$  with temperature has a very low temperature coefficient of 35 ppm/°C.

**PROGRAMMING THE POTENTIOMETER DIVIDER**

**Voltage Output Operation**

The digital potentiometer easily generates a voltage divider at wiper to B and wiper to A, proportional to the input voltage at A to B. Unlike the polarity of  $V_{DD}$  to GND, which must be positive, voltage across A to B, W to A, and W to B can be at either polarity.

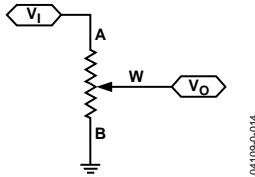

Figure 39. Potentiometer Mode Configuration

If ignoring the effect of the wiper resistance for approximation, connecting the A terminal to 5 V and the B terminal to ground produces an output voltage at the wiper to B, starting at 0 V up to 1 LSB less than 5 V. Each LSB of voltage is equal to the voltage applied across Terminal A and Terminal B divided by the 256 positions of the potentiometer divider. The general equation defining the output voltage at  $V_W$  with respect to ground for any valid input voltage applied to Terminal A and Terminal B is

$$V_W(D) = \frac{D}{256} V_A + \frac{256 - D}{256} V_B \quad (3)$$

Operation of the digital potentiometer in the divider mode results in more accurate operation over temperature. Unlike in the rheostat mode, the output voltage is dependent mainly on the ratio of the internal resistors,  $R_{WA}$  and  $R_{WB}$ , not on the absolute values. Therefore, the temperature drift reduces to 15 ppm/°C.

**ESD PROTECTION**

All digital inputs are protected with a series of input resistors and parallel Zener ESD structures, as shown in Figure 40 and Figure 41. This applies to the SDA, SCL, AD0, and AD1 digital input pins (AD5248 only).

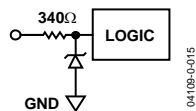

Figure 40. ESD Protection of Digital Pins

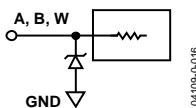

Figure 41. ESD Protection of Resistor Terminals

**TERMINAL VOLTAGE OPERATING RANGE**

The AD5243/AD5248  $V_{DD}$  and GND power supply defines the boundary conditions for proper 3-terminal digital potentiometer operation. Supply signals present on the A, B, and W terminals that exceed  $V_{DD}$  or GND are clamped by the internal forward-biased diodes (see Figure 42).

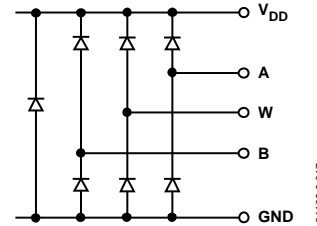

Figure 42. Maximum Terminal Voltages Set by  $V_{DD}$  and GND

**POWER-UP SEQUENCE**

Because the ESD protection diodes limit the voltage compliance at the A, B, and W terminals (see Figure 42), it is important to power  $V_{DD}$ /GND before applying voltage to the A, B, and W terminals; otherwise, the diode is forward-biased such that  $V_{DD}$  is powered unintentionally and may affect the rest of the user's circuit. The ideal power-up sequence is in the following order: GND,  $V_{DD}$ , digital inputs, and then  $V_A$ ,  $V_B$ , and  $V_W$ . The relative order of powering  $V_A$ ,  $V_B$ ,  $V_W$ , and the digital inputs is not important, as long as they are powered after  $V_{DD}$ /GND.

**LAYOUT AND POWER SUPPLY BYPASSING**

It is a good practice to employ compact, minimum lead length layout design. The leads to the inputs should be as direct as possible with a minimum conductor length. Ground paths should have low resistance and low inductance.

Similarly, it is also good practice to bypass the power supplies with quality capacitors for optimum stability. Supply leads to the device should be bypassed with disc or chip ceramic capacitors of 0.01  $\mu F$  to 0.1  $\mu F$ . Low ESR 1  $\mu F$  to 10  $\mu F$  tantalum or electrolytic capacitors should also be applied at the supplies to minimize any transient disturbance and low frequency ripple (see Figure 43). In addition, note that the digital ground should be joined remotely to the analog ground at one point to minimize the ground bounce.

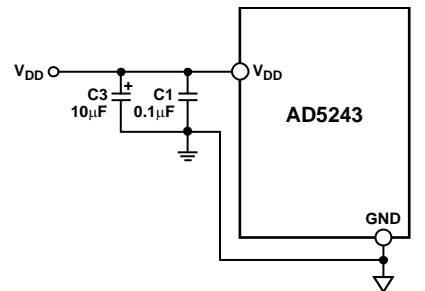

Figure 43. Power Supply Bypassing

### CONSTANT BIAS TO RETAIN RESISTANCE SETTING

For users who desire nonvolatility but cannot justify the additional cost of an EEMEM, the AD5243/AD5248 can be considered low cost alternatives by maintaining a constant bias to retain the wiper setting. The AD5243/AD5248 are designed specifically for low power applications, allowing low power consumption even in battery-operated systems. The graph in Figure 44 demonstrates the power consumption from a 3.4 V, 450 mAh Li-Ion cell phone battery connected to the AD5243/AD5248. The measurement over time shows that the device draws approximately 1.3  $\mu\text{A}$  and consumes negligible power. Over a course of 30 days, the battery is depleted by less than 2%, the majority of which is due to the intrinsic leakage current of the battery itself.

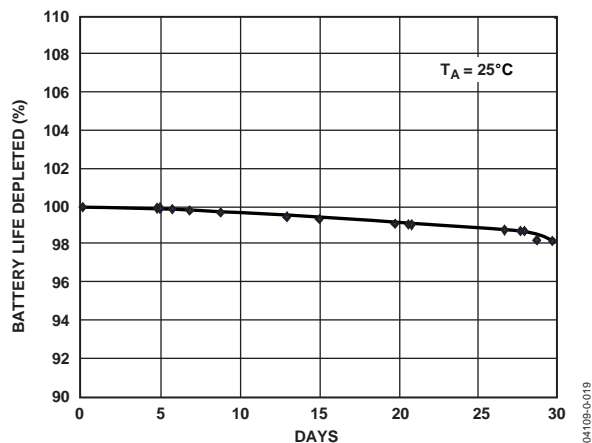

Figure 44. Battery Operating Life Depletion

This demonstrates that constantly biasing the potentiometer can be a practical approach. Most portable devices do not require the removal of batteries for the purpose of charging. Although the resistance setting of the AD5243/AD5248 is lost when the battery needs replacement, such events occur rather infrequently such that this inconvenience is justified by the lower cost and smaller size offered by the AD5243/AD5248. If total power is lost, the user should be provided with a means to adjust the setting accordingly.

## I<sup>2</sup>C INTERFACE

### I<sup>2</sup>C COMPATIBLE, 2-WIRE SERIAL BUS

The 2-wire, I<sup>2</sup>C-compatible serial bus protocol operates as follows:

1. The master initiates data transfer by establishing a start condition, which is when a high-to-low transition on the SDA line occurs while SCL is high (see Figure 45). The following byte is the slave address byte, which consists of the slave address followed by an R/W bit (this bit determines whether data is read from or written to the slave device). The AD5243 has a fixed slave address byte, whereas the AD5248 has two configurable address bits, AD0 and AD1 (see Figure 10).

The slave whose address corresponds to the transmitted address responds by pulling the SDA line low during the ninth clock pulse (this is called the acknowledge bit). At this stage, all other devices on the bus remain idle while the selected device waits for data to be written to or read from its serial register. If the R/W bit is high, the master reads from the slave device. On the other hand, if the R/W bit is low, the master writes to the slave device.

2. In the write mode, the second byte is the instruction byte. The first bit (MSB) of the instruction byte is the RDAC subaddress select bit. A logic low selects Channel 1 and a logic high selects Channel 2.

The second MSB, SD, is a shutdown bit. A logic high causes an open circuit at Terminal A while shorting the wiper to Terminal B. This operation yields almost 0 Ω in rheostat mode or 0 V in potentiometer mode. It is important to note that the shutdown operation does not disturb the contents of the register. When the AD5243 or AD5248 is brought out of shutdown, the previous setting is applied to the RDAC. In addition, during shutdown, new settings can be programmed. When the part is returned from shutdown, the corresponding VR setting is applied to the RDAC.

The remainder of the bits in the instruction byte are don't care bits (see Figure 10).

After acknowledging the instruction byte, the last byte in write mode is the data byte. Data is transmitted over the serial bus in sequences of nine clock pulses (eight data bits followed by an acknowledge bit). The transitions on the

SDA line must occur during the low period of SCL and remain stable during the high period of SCL (see Figure 45 and Figure 46).

3. In the read mode, the data byte follows immediately after the acknowledgment of the slave address byte. Data is transmitted over the serial bus in sequences of nine clock pulses (a slight difference with the write mode, where there are eight data bits followed by an acknowledge bit). Similarly, the transitions on the SDA line must occur during the low period of SCL and remain stable during the high period of SCL (see Figure 47 and Figure 48).

Note that the channel of interest is the one that is previously selected in write mode. If users need to read the RDAC values of both channels, they need to program the first channel in write mode and then change to read mode to read the first channel value. After that, the user must return the device to write mode with the second channel selected and read the second channel value in read mode. It is not necessary for users to issue the Frame 3 data byte in write mode for subsequent readback operation. Users should refer to Figure 47 and Figure 48 for the programming format.

4. After all data bits have been read or written, a stop condition is established by the master. A stop condition is defined as a low-to-high transition on the SDA line while SCL is high. In write mode, the master pulls the SDA line high during the 10<sup>th</sup> clock pulse to establish a stop condition (see Figure 45 and Figure 46). In read mode, the master issues a no acknowledge for the ninth clock pulse (that is, the SDA line remains high). The master then brings the SDA line low before the 10<sup>th</sup> clock pulse, which goes high to establish a stop condition (see Figure 47 and Figure 48).

A repeated write function provides the user with the flexibility of updating the RDAC output multiple times after addressing and instructing the part only once. For example, after the RDAC has acknowledged its slave address and instruction bytes in write mode, the RDAC output updates on each successive byte. If different instructions are needed, however, the write/read mode must restart with a new slave address, instruction, and data byte. Similarly, a repeated read function of the RDAC is also allowed.

**Write Mode**

**Table 9. AD5243 Write Mode**

|                    |   |   |   |   |   |   |   |   |                  |    |    |   |   |   |   |   |   |           |    |    |    |    |    |    |    |    |   |   |
|--------------------|---|---|---|---|---|---|---|---|------------------|----|----|---|---|---|---|---|---|-----------|----|----|----|----|----|----|----|----|---|---|
| S                  | 0 | 1 | 0 | 1 | 1 | 1 | 1 | W | A                | A0 | SD | X | X | X | X | X | X | A         | D7 | D6 | D5 | D4 | D3 | D2 | D1 | D0 | A | P |
| Slave address byte |   |   |   |   |   |   |   |   | Instruction byte |    |    |   |   |   |   |   |   | Data byte |    |    |    |    |    |    |    |    |   |   |

**Table 10. AD5248 Write Mode**

|                    |   |   |   |   |   |     |     |   |                  |    |    |   |   |   |   |   |   |           |    |    |    |    |    |    |    |    |   |   |
|--------------------|---|---|---|---|---|-----|-----|---|------------------|----|----|---|---|---|---|---|---|-----------|----|----|----|----|----|----|----|----|---|---|
| S                  | 0 | 1 | 0 | 1 | 1 | AD1 | AD0 | W | A                | A0 | SD | X | X | X | X | X | X | A         | D7 | D6 | D5 | D4 | D3 | D2 | D1 | D0 | A | P |
| Slave address byte |   |   |   |   |   |     |     |   | Instruction byte |    |    |   |   |   |   |   |   | Data byte |    |    |    |    |    |    |    |    |   |   |

**Read Mode**

**Table 11. AD5243 Read Mode**

|                    |   |   |   |   |   |   |   |   |           |    |    |    |    |    |    |    |    |   |   |
|--------------------|---|---|---|---|---|---|---|---|-----------|----|----|----|----|----|----|----|----|---|---|
| S                  | 0 | 1 | 0 | 1 | 1 | 1 | 1 | R | A         | D7 | D6 | D5 | D4 | D3 | D2 | D1 | D0 | A | P |
| Slave address byte |   |   |   |   |   |   |   |   | Data byte |    |    |    |    |    |    |    |    |   |   |

**Table 12. AD5248 Read Mode**

|                    |   |   |   |   |   |     |     |   |           |    |    |    |    |    |    |    |    |   |   |
|--------------------|---|---|---|---|---|-----|-----|---|-----------|----|----|----|----|----|----|----|----|---|---|
| S                  | 0 | 1 | 0 | 1 | 1 | AD1 | AD0 | R | A         | D7 | D6 | D5 | D4 | D3 | D2 | D1 | D0 | A | P |
| Slave address byte |   |   |   |   |   |     |     |   | Data byte |    |    |    |    |    |    |    |    |   |   |

**Table 13. SDA Bits Descriptions**

| Bit                            | Description  |
|--------------------------------|--|
| S                              | Start condition.   |
| P                              | Stop condition.  |
| A                              | Acknowledge.   |
| AD0, AD1                       | Package pin-programmable address bits.   |
| X                              | Don't care.  |
| $\overline{W}$                 | Write.   |
| R                              | Read.  |
| A0                             | RDAC subaddress select bit.  |
| SD                             | Shutdown connects wiper to B terminal and open circuits the A terminal. It does not change the contents of the wiper register. |
| D7, D6, D5, D4, D3, D2, D1, D0 | Data bits.   |

I<sup>2</sup>C CONTROLLER PROGRAMMING

Write Bit Patterns

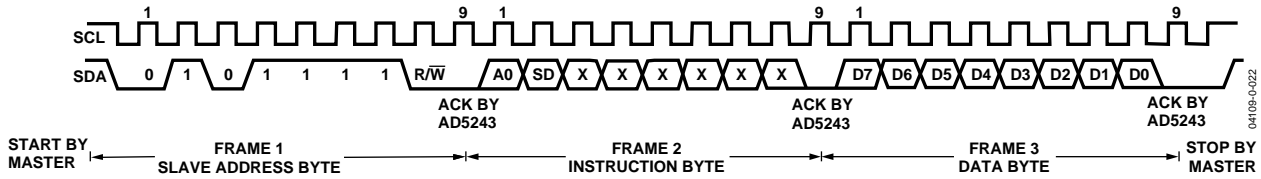

Figure 45. Writing to the RDAC Register—AD5243

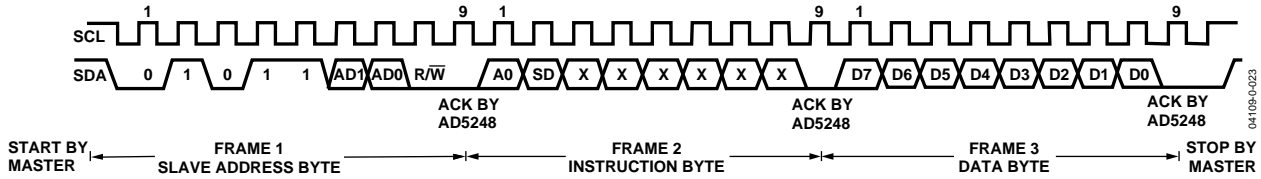

Figure 46. Writing to the RDAC Register—AD5248

Read Bit Patterns

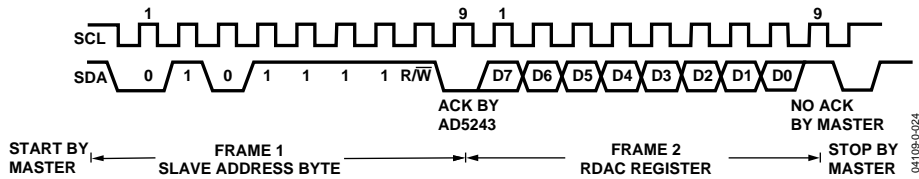

Figure 47. Reading Data from a Previously Selected RDAC Register in Write Mode—AD5243

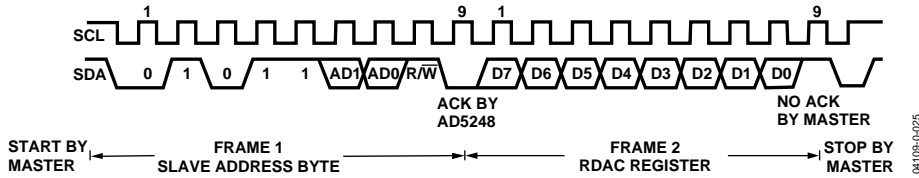

Figure 48. Reading Data from a Previously Selected RDAC Register in Write Mode—AD5248

Multiple Devices on One Bus (Applies Only to AD5248)

Figure 49 shows four AD5248 devices on the same serial bus. Each has a different slave address because the states of their AD0 and AD1 pins are different. This allows each device on the bus to be written to or read from independently. The master device output bus line drivers are open-drain pull-downs in a fully I<sup>2</sup>C-compatible interface.

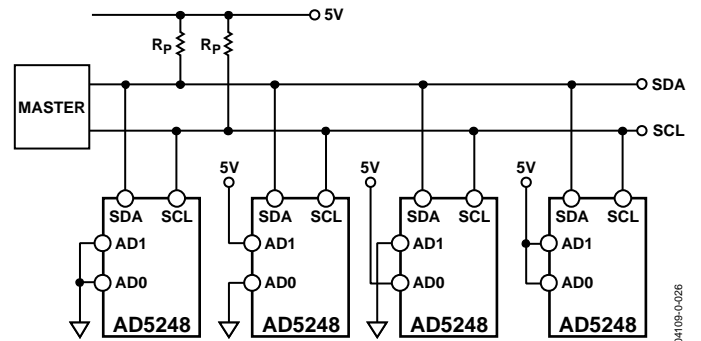
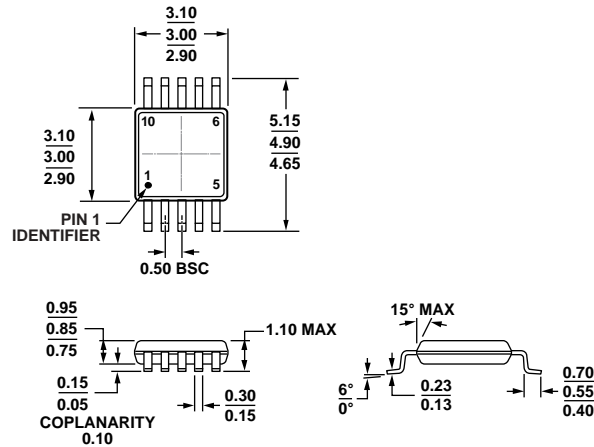

Figure 49. Multiple AD5248 Devices on One I<sup>2</sup>C Bus

### OUTLINE DIMENSIONS



COMPLIANT TO JEDEC STANDARDS MO-187-BA

Figure 50. 10-Lead Mini Small Outline Package [MSOP] (RM-10)

Dimensions shown in millimeters

001709-A

### ORDERING GUIDE

| Model <sup>1,2</sup> | R <sub>AB</sub> | Temperature     | Package Description | Package Option | Branding |
|----------------------|-----------------|-----------------|---------------------|----------------|----------|
| AD5243BRM2.5         | 2.5 kΩ          | -40°C to +125°C | 10-Lead MSOP        | RM-10          | D0L      |
| AD5243BRM10          | 10 kΩ           | -40°C to +125°C | 10-Lead MSOP        | RM-10          | D0M      |
| AD5243BRM100         | 100 kΩ          | -40°C to +125°C | 10-Lead MSOP        | RM-10          | D0P      |
| AD5243BRMZ2.5        | 2.5 kΩ          | -40°C to +125°C | 10-Lead MSOP        | RM-10          | D9X      |
| AD5243BRMZ2.5-RL7    | 2.5 kΩ          | -40°C to +125°C | 10-Lead MSOP        | RM-10          | D9X      |
| AD5243BRMZ10         | 10 kΩ           | -40°C to +125°C | 10-Lead MSOP        | RM-10          | D0M      |
| AD5243BRMZ10-RL7     | 10 kΩ           | -40°C to +125°C | 10-Lead MSOP        | RM-10          | D0M      |
| AD5243BRMZ50         | 50 kΩ           | -40°C to +125°C | 10-Lead MSOP        | RM-10          | D0N      |
| AD5243BRMZ50-RL7     | 50 kΩ           | -40°C to +125°C | 10-Lead MSOP        | RM-10          | D0N      |
| AD5243BRMZ100        | 100 kΩ          | -40°C to +125°C | 10-Lead MSOP        | RM-10          | D0P      |
| AD5243BRMZ100-RL7    | 100 kΩ          | -40°C to +125°C | 10-Lead MSOP        | RM-10          | D0P      |
| EVAL-AD5243SDZ       |                 |                 | Evaluation Board    |                |          |
| AD5248BRM100         | 100 kΩ          | -40°C to +125°C | 10-Lead MSOP        | RM-10          | D1J      |
| AD5248BRMZ2.5        | 2.5 kΩ          | -40°C to +125°C | 10-Lead MSOP        | RM-10          | D1F      |
| AD5248BRMZ2.5-RL7    | 2.5 kΩ          | -40°C to +125°C | 10-Lead MSOP        | RM-10          | D1F      |
| AD5248BRMZ10         | 10 kΩ           | -40°C to +125°C | 10-Lead MSOP        | RM-10          | D8Z      |
| AD5248BRMZ10-RL7     | 10 kΩ           | -40°C to +125°C | 10-Lead MSOP        | RM-10          | D8Z      |
| AD5248BRMZ50         | 50 kΩ           | -40°C to +125°C | 10-Lead MSOP        | RM-10          | D90      |
| AD5248BRMZ50-RL7     | 50 kΩ           | -40°C to +125°C | 10-Lead MSOP        | RM-10          | D90      |
| AD5248BRMZ100        | 100 kΩ          | -40°C to +125°C | 10-Lead MSOP        | RM-10          | D91      |
| AD5248BRMZ100-RL7    | 100 kΩ          | -40°C to +125°C | 10-Lead MSOP        | RM-10          | D91      |

<sup>1</sup> Z = RoHS Compliant Part.

<sup>2</sup> The evaluation board is shipped with the 10 kΩ R<sub>AB</sub> resistor option; however, the board is compatible with all available resistor value options.

**NOTES**

I<sup>2</sup>C refers to a communications protocol originally developed by Philips Semiconductors (now NXP Semiconductors).

## Looking for pricing, stock, or lifecycle information?

Click below to explore more details on WIN SOURCE:

- ⊖ [View AD5248BRMZ10-RL7 on WIN SOURCE](#)
- ⊖ [Analog Devices Inc. Information](#)

## Optimize Your Supply Chain with WIN SOURCE Solutions

- ✓ Global Sourcing Solution
- ✓ Obsolete Management
- ✓ Cost Control Management
- ✓ Shortage Management
- ✓ Alternative Solution
- ✓ Excess Inventory Management