



**THE DATASHEET OF
VS-50WQ06FNHM3**





Schottky Rectifier, 5.5 A



D-PAK (TO-252AA)

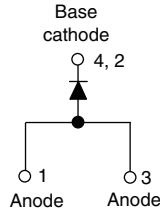

FEATURES

- Low forward voltage drop
- Guard ring for enhanced ruggedness and long term reliability
- Popular D-PAK outline
- Small foot print, surface mountable
- High frequency operation
- AEC-Q101 qualified
- Meets JESD 201 class 2 whisker test
- Meets MSL level 1, per J-STD-020, LF maximum peak of 260 °C
- Material categorization: For definitions of compliance please see www.vishay.com/doc?99912



RoHS
COMPLIANT
HALOGEN
FREE

PRODUCT SUMMARY	
Package	D-PAK (TO-252AA)
$I_{F(AV)}$	5.5 A
V_R	60 V
V_F at I_F	See Electrical table
I_{RM}	35 mA at 125 °C
T_J max.	150 °C
Diode variation	Single die
E_{AS}	7 mJ

DESCRIPTION

The VS-50WQ06FNHM3 surface mount Schottky rectifier has been designed for applications requiring low forward drop and small foot prints on PC board. Typical applications are in disk drives, switching power supplies, converters, freewheeling diodes, battery charging, and reverse battery protection.

MAJOR RATINGS AND CHARACTERISTICS			
SYMBOL	CHARACTERISTICS	VALUES	UNITS
$I_{F(AV)}$	Rectangular waveform	5.5	A
V_{RRM}		60	V
I_{FSM}	$t_p = 5 \mu s$ sine	320	A
V_F	$5 A_{pk}, T_J = 125 \text{ }^\circ C$	0.54	V
T_J	Range	- 40 to 150	°C

VOLTAGE RATINGS			
PARAMETER	SYMBOL	VS-50WQ06FNHM3	UNITS
Maximum DC reverse voltage	V_R	60	V
Maximum working peak reverse voltage	V_{RWM}		

ABSOLUTE MAXIMUM RATINGS					
PARAMETER	SYMBOL	TEST CONDITIONS		VALUES	UNITS
Maximum average forward current See fig. 5	$I_{F(AV)}$	50 % duty cycle at $T_C = 132 \text{ }^\circ C$, rectangular waveform		5.5	A
Maximum peak one cycle non-repetitive surge current See fig. 7	I_{FSM}	5 μs sine or 3 μs rect. pulse	Following any rated load condition and with rated V_{RRM} applied	320	
		10 ms sine or 6 ms rect. pulse		105	
Non-repetitive avalanche energy	E_{AS}	$T_J = 25 \text{ }^\circ C, I_{AS} = 1.2 \text{ A}, L = 10 \text{ mH}$		7	mJ
Repetitive avalanche current	I_{AR}	Current decaying linearly to zero in 1 μs Frequency limited by T_J maximum $V_A = 1.5 \times V_R$ typical		0.8	A



ELECTRICAL SPECIFICATIONS					
PARAMETER	SYMBOL	TEST CONDITIONS		VALUES	UNITS
Maximum forward voltage drop See fig. 1	$V_{FM}^{(1)}$	5 A	$T_J = 25\text{ }^\circ\text{C}$	0.57	V
		10 A		0.74	
		5 A	$T_J = 125\text{ }^\circ\text{C}$	0.54	
		10 A		0.68	
Maximum reverse leakage current See fig. 2	$I_{RM}^{(1)}$	$T_J = 25\text{ }^\circ\text{C}$	$V_R = \text{Rated } V_R$	3	mA
		$T_J = 125\text{ }^\circ\text{C}$		35	
Threshold voltage	$V_{F(TO)}$	$T_J = T_J \text{ maximum}$		0.35	V
Forward slope resistance	r_t			25.5	m Ω
Typical junction capacitance	C_T	$V_R = 5\text{ }V_{DC}$ (test signal range 100 kHz to 1 MHz), 25 $^\circ\text{C}$		360	pF
Typical series inductance	L_S	Measured lead to lead 5 mm from package body		5.0	nH
Maximum voltage rate of change	dV/dt	Rated V_R		10 000	V/ μs

Note(1) Pulse width < 300 μs , duty cycle < 2 %

THERMAL - MECHANICAL SPECIFICATIONS					
PARAMETER	SYMBOL	TEST CONDITIONS		VALUES	UNITS
Maximum junction and storage temperature range	$T_J^{(1)}, T_{Stg}$			- 40 to 150	$^\circ\text{C}$
Maximum thermal resistance, junction to case	R_{thJC}	DC operation See fig. 4		3.0	$^\circ\text{C/W}$
Approximate weight				0.3	g
				0.01	oz.
Marking device		Case style D-PAK		50WQ06FNH	

Note(1) $\frac{dP_{tot}}{dT_J} < \frac{1}{R_{thJA}}$ thermal runaway condition for a diode on its own heatsink

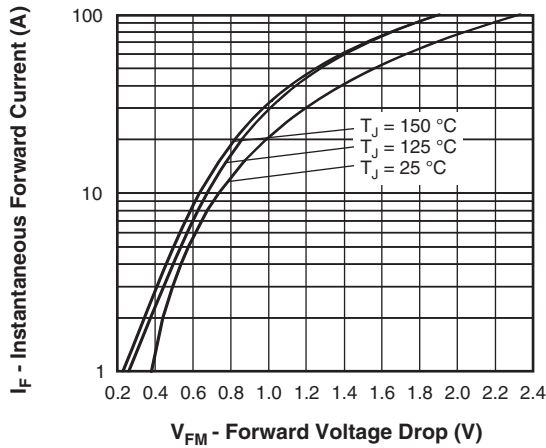

Fig. 1 - Maximum Forward Voltage Drop Characteristics

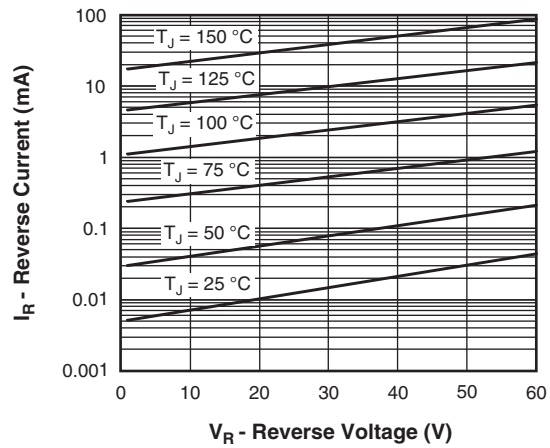

Fig. 2 - Typical Values of Reverse Current vs. Reverse Voltage

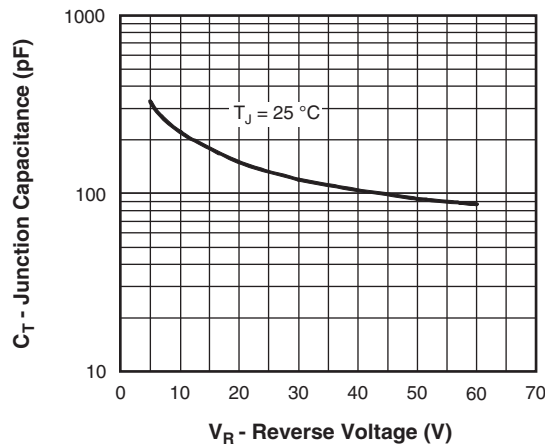

Fig. 3 - Typical Junction Capacitance vs. Reverse Voltage

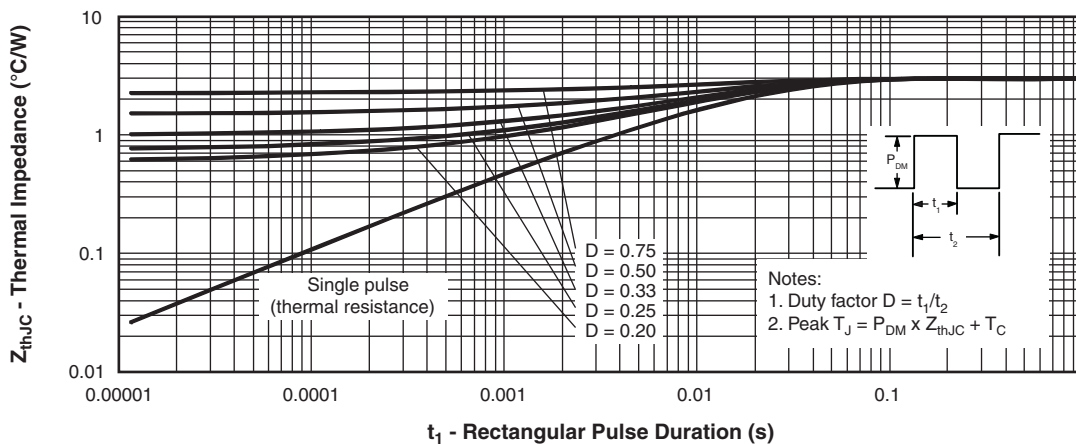

Fig. 4 - Maximum Thermal Impedance Z_{thJC} Characteristics

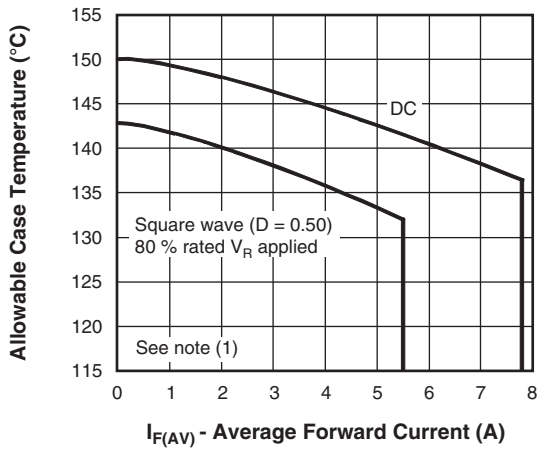

Fig. 5 - Maximum Allowable Case Temperature vs. Average Forward Current

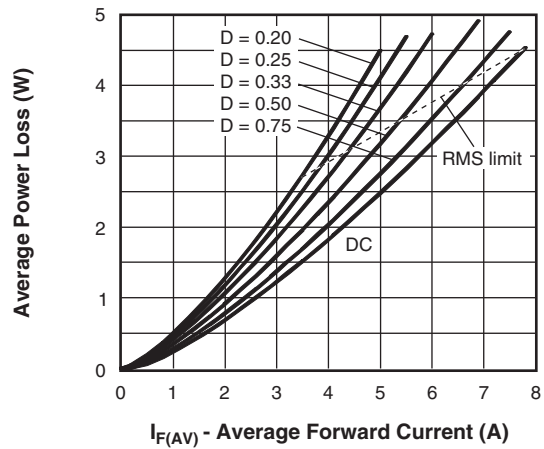

Fig. 6 - Forward Power Loss Characteristics

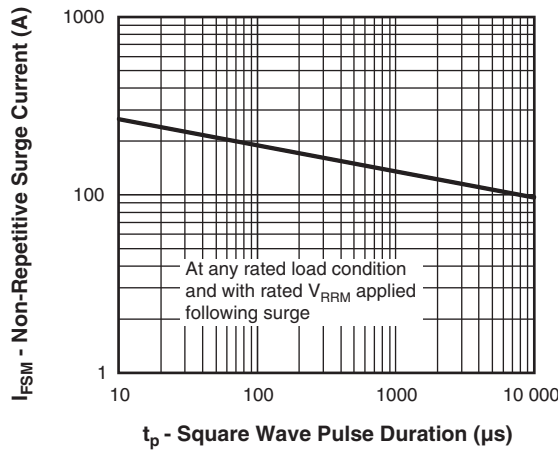

Fig. 7 - Maximum Non-Repetitive Surge Current

Note

- (1) Formula used: $T_C = T_J - (P_d + P_{d_{REV}}) \times R_{thJC}$;
 P_d = Forward power loss = $I_{F(AV)} \times V_{FM}$ at $(I_{F(AV)}/D)$ (see fig. 6);
 $P_{d_{REV}}$ = Inverse power loss = $V_{R1} \times I_R (1 - D)$; I_R at $V_{R1} = 80\%$ rated V_R



ORDERING INFORMATION TABLE

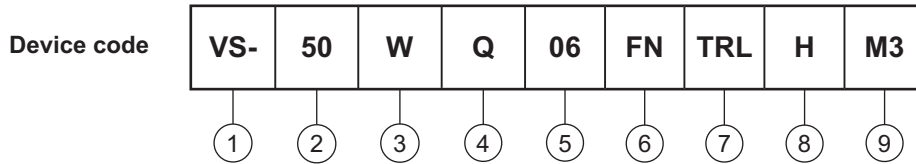

- 1** - Vishay Semiconductors product
- 2** - Current rating (5.5 A)
- 3** - Package identifier:
W = D-PAK
- 4** - Schottky "Q" series
- 5** - Voltage rating (06 = 60 V)
- 6** - FN = TO-252AA (D-PAK)
- 7** -
 - None = Tube
 - TR = Tape and reel
 - TRL = Tape and reel (left oriented)
 - TRR = Tape and reel (right oriented)
- 8** - H = AEC-Q101 qualified
- 9** - Environmental digit:
M3 = Halogen-free, RoHS-compliant, and terminations lead (Pb)-free

ORDERING INFORMATION (Example)			
PREFERRED P/N	QUANTITY PER T/R	MINIMUM ORDER QUANTITY	PACKAGING DESCRIPTION
VS-50WQ06FNHM3	75	3000	Antistatic plastic tube
VS-50WQ06FNTRHM3	2000	2000	13" diameter reel
VS-50WQ06FNTRRH3	3000	3000	13" diameter reel
VS-50WQ06FNTRLHM3	3000	3000	13" diameter reel

LINKS TO RELATED DOCUMENTS	
Dimensions	www.vishay.com/doc?95519
Part marking information	www.vishay.com/doc?95518
Packaging information	www.vishay.com/doc?95033



D-PAK (TO-252AA)

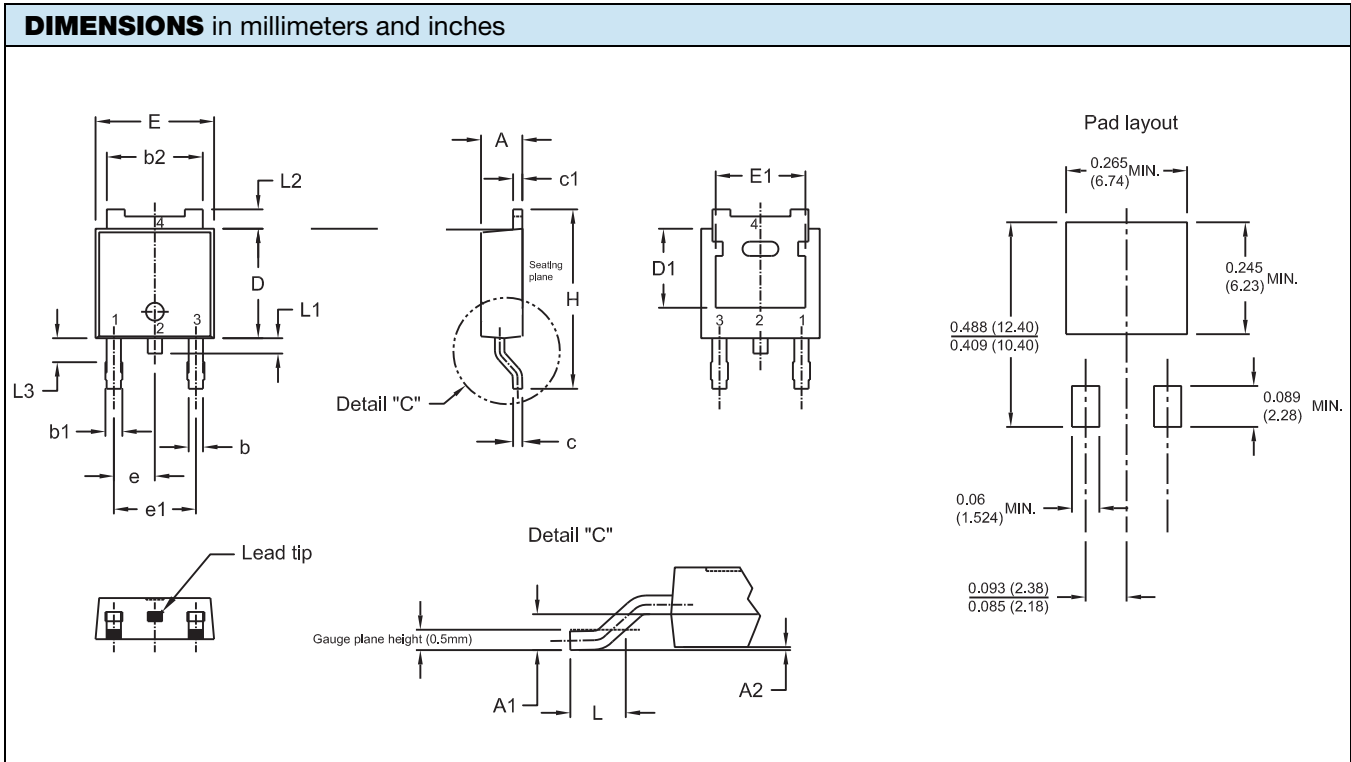

SYMBOL	MILLIMETERS		INCHES		NOTES	SYMBOL	MILLIMETERS		INCHES		NOTES
	MIN.	MAX.	MIN.	MAX.			MIN.	MAX.	MIN.	MAX.	
A	2.21	2.38	0.087	0.094		A1	0.89	1.14	0.035	0.045	
A2	0.76	1.14	0.030	0.045		H	9.65	10.41	0.380	0.410	
b	0.71	0.88	0.028	0.035		L	1.40	1.78	0.055	0.070	
b1	0.76	1.14	0.030	0.045		e	2.28 BSC		0.09 BSC		
b2	5.23	5.44	0.206	0.214		e1	4.57 BSC		0.18 BSC		
C	0.46	0.58	0.018	0.023		L1	0.64	1.02	0.025	0.040	
C1	0.46	0.58	0.018	0.023		L2	0.89	1.27	0.035	0.050	
D	5.97	6.22	0.235	0.2455		L3	1.15	1.52	0.040	0.060	
D1	4.32	4.45	0.170	0.175							
E	6.48	6.73	0.255	0.2655							
E1	4.49	5.50	0.177	0.217							

Notes

- (1) Dimensioning and tolerancing as per ASME Y14.5M-1994
- (2) Lead dimension uncontrolled in L3 only for reference
- (3) Dimension D1, E1, L2 and b2 establish a minimum mounting surface for thermal pad
- (4) Dimensions D and E do not include mold flash.
- (5) Outline conforms to JEDEC outline TO-252AA



Disclaimer

ALL PRODUCT, PRODUCT SPECIFICATIONS AND DATA ARE SUBJECT TO CHANGE WITHOUT NOTICE TO IMPROVE RELIABILITY, FUNCTION OR DESIGN OR OTHERWISE.

Vishay Intertechnology, Inc., its affiliates, agents, and employees, and all persons acting on its or their behalf (collectively, "Vishay"), disclaim any and all liability for any errors, inaccuracies or incompleteness contained in any datasheet or in any other disclosure relating to any product.

Vishay makes no warranty, representation or guarantee regarding the suitability of the products for any particular purpose or the continuing production of any product. To the maximum extent permitted by applicable law, Vishay disclaims (i) any and all liability arising out of the application or use of any product, (ii) any and all liability, including without limitation special, consequential or incidental damages, and (iii) any and all implied warranties, including warranties of fitness for particular purpose, non-infringement and merchantability.

Statements regarding the suitability of products for certain types of applications are based on Vishay's knowledge of typical requirements that are often placed on Vishay products in generic applications. Such statements are not binding statements about the suitability of products for a particular application. It is the customer's responsibility to validate that a particular product with the properties described in the product specification is suitable for use in a particular application. Parameters provided in datasheets and / or specifications may vary in different applications and performance may vary over time. All operating parameters, including typical parameters, must be validated for each customer application by the customer's technical experts. Product specifications do not expand or otherwise modify Vishay's terms and conditions of purchase, including but not limited to the warranty expressed therein.

Except as expressly indicated in writing, Vishay products are not designed for use in medical, life-saving, or life-sustaining applications or for any other application in which the failure of the Vishay product could result in personal injury or death. Customers using or selling Vishay products not expressly indicated for use in such applications do so at their own risk. Please contact authorized Vishay personnel to obtain written terms and conditions regarding products designed for such applications.

No license, express or implied, by estoppel or otherwise, to any intellectual property rights is granted by this document or by any conduct of Vishay. Product names and markings noted herein may be trademarks of their respective owners.

Looking for pricing, stock, or lifecycle information?

Click below to explore more details on WIN SOURCE:

 [View VS-50WQ06FNHM3 on WIN SOURCE](#)

 [Vishay Information](#)

Optimize Your Supply Chain with WIN SOURCE Solutions

-  Global Sourcing Solution
-  Obsolete Management
-  Cost Control Management
-  Shortage Management
-  Alternative Solution
-  Excess Inventory Management