



**THE DATASHEET OF  
MC33078DRE4**



## FEATURES

- Dual-Supply Operation . . .  $\pm 5$  V to  $\pm 18$  V
- Low Noise Voltage . . .  $4.5 \text{ nV}/\sqrt{\text{Hz}}$
- Low Input Offset Voltage . . .  $0.15 \text{ mV}$
- Low Total Harmonic Distortion . . .  $0.002\%$
- High Slew Rate . . .  $7 \text{ V}/\mu\text{s}$
- High-Gain Bandwidth Product . . .  $16 \text{ MHz}$
- High Open-Loop AC Gain . . .  $800$  at  $20 \text{ kHz}$
- Large Output-Voltage Swing . . .  $14.1 \text{ V}$  to  $-14.6 \text{ V}$
- Excellent Gain and Phase Margins

D (SOIC), DGK (MSOP), OR P (PDIP) PACKAGE  
(TOP VIEW)

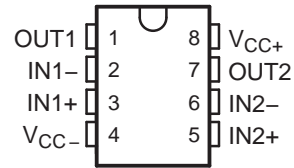

## DESCRIPTION/ORDERING INFORMATION

The MC33078 is a bipolar dual operational amplifier with high-performance specifications for use in quality audio and data-signal applications. This device operates over a wide range of single- and dual-supply voltages and offers low noise, high-gain bandwidth, and high slew rate. Additional features include low total harmonic distortion, excellent phase and gain margins, large output voltage swing with no deadband crossover distortion, and symmetrical sink/source performance.

### ORDERING INFORMATION

| $T_A$         | PACKAGE <sup>(1)</sup> |              | ORDERABLE PART NUMBER | TOP-SIDE MARKING <sup>(2)</sup> |
|---------------|------------------------|--------------|-----------------------|---------------------------------|
| -40°C to 85°C | PDIP – P               | Tube of 50   | MC33078P              | MC33078P                        |
|               | SOIC – D               | Tube of 75   | MC33078D              | M33078                          |
|               |                        | Reel of 2500 | MC33078DR             |                                 |
|               | VSSOP/MSOP – DGK       | Reel of 2500 | MC33078DGKR           | MY_                             |
|               |                        | Reel of 250  | MC33078DGKT           |                                 |

(1) Package drawings, standard packing quantities, thermal data, symbolization, and PCB design guidelines are available at [www.ti.com/sc/package](http://www.ti.com/sc/package).

(2) DGK: The actual top-side marking has one additional character that designates the assembly/test site.

### SYMBOL (EACH AMPLIFIER)

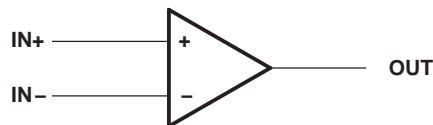

Please be aware that an important notice concerning availability, standard warranty, and use in critical applications of Texas Instruments semiconductor products and disclaimers thereto appears at the end of this data sheet.

### Absolute Maximum Ratings<sup>(1)</sup>

over operating free-air temperature range (unless otherwise noted)

|                                     |   | MIN         | MAX                                  | UNIT |
|-------------------------------------|---|-------------|--------------------------------------|------|
| V <sub>CC+</sub>                    | Supply voltage <sup>(2)</sup>                                     |             | 18                                   | V    |
| V <sub>CC-</sub>                    | Supply voltage <sup>(2)</sup>                                     |             | -18                                  | V    |
| V <sub>CC+</sub> - V <sub>CC-</sub> | Supply voltage  |             | 36                                   | V    |
|                                     | Input voltage, either input <sup>(2)(3)</sup>                     |             | V <sub>CC+</sub> or V <sub>CC-</sub> | V    |
|                                     | Input current <sup>(4)</sup>                                      |             | ±10                                  | mA   |
|                                     | Duration of output short circuit <sup>(5)</sup>                   |             | Unlimited                            |      |
| θ <sub>JA</sub>                     | Package thermal impedance, junction to free air <sup>(6)(7)</sup> | D package   | 97                                   | °C/W |
|                                     |   | DGK package | 172                                  |      |
|                                     |   | P package   | 85                                   |      |
| T <sub>J</sub>                      | Operating virtual junction temperature                            |             | 150                                  | °C   |
| T <sub>stg</sub>                    | Storage temperature range   | -65         | 150                                  | °C   |

- (1) Stresses beyond those listed under *Absolute Maximum Ratings* may cause permanent damage to the device. These are stress ratings only, and functional operation of the device at these or any other conditions beyond those indicated under *Recommended Operating Conditions* is not implied. Exposure to absolute-maximum-rated conditions for extended periods may affect device reliability.
- (2) All voltage values, except differential voltages, are with respect to the midpoint between V<sub>CC+</sub> and V<sub>CC-</sub>.
- (3) The magnitude of the input voltage must never exceed the magnitude of the supply voltage.
- (4) Excessive input current will flow if a differential input voltage in excess of approximately 0.6 V is applied between the inputs, unless some limiting resistance is used.
- (5) The output may be shorted to ground or either power supply. Temperature and/or supply voltages must be limited to ensure the maximum dissipation rating is not exceeded.
- (6) Maximum power dissipation is a function of T<sub>J(max)</sub>, θ<sub>JA</sub>, and T<sub>A</sub>. The maximum allowable power dissipation at any allowable ambient temperature is P<sub>D</sub> = (T<sub>J(max)</sub> - T<sub>A</sub>)/θ<sub>JA</sub>. Operating at the absolute maximum T<sub>J</sub> of 150°C can affect reliability.
- (7) The package thermal impedance is calculated in accordance with JESD 51-7.

### Recommended Operating Conditions

|                  |                                      | MIN | MAX | UNIT |
|------------------|--------------------------------------|-----|-----|------|
| V <sub>CC-</sub> | Supply voltage                       | -5  | -18 | V    |
| V <sub>CC+</sub> |                                      | 5   | 18  |      |
| T <sub>A</sub>   | Operating free-air temperature range | -40 | 85  | °C   |

### Electrical Characteristics

$V_{CC-} = -15\text{ V}$ ,  $V_{CC+} = 15\text{ V}$ ,  $T_A = 25^\circ\text{C}$  (unless otherwise noted)

| PARAMETER       |   | TEST CONDITIONS   |   | MIN       | TYP      | MAX   | UNIT                         |
|-----------------|---|---|---|-----------|----------|-------|------------------------------|
| $V_{IO}$        | Input offset voltage                            | $V_O = 0$ , $R_S = 10\ \Omega$ , $V_{CM} = 0$                                       | $T_A = 25^\circ\text{C}$                        | 0.15      | 2        |       | mV                           |
|                 |   |   | $T_A = -40^\circ\text{C}$ to $85^\circ\text{C}$ |           |          | 3     |                              |
| $\alpha V_{IO}$ | Input offset voltage temperature coefficient    | $V_O = 0$ , $R_S = 10\ \Omega$ , $V_{CM} = 0$                                       | $T_A = -40^\circ\text{C}$ to $85^\circ\text{C}$ |           | 2        |       | $\mu\text{V}/^\circ\text{C}$ |
| $I_{IB}$        | Input bias current                              | $V_O = 0$ , $V_{CM} = 0$  | $T_A = 25^\circ\text{C}$                        |           | 300      | 750   | nA                           |
|                 |   |   | $T_A = -40^\circ\text{C}$ to $85^\circ\text{C}$ |           |          | 800   |                              |
| $I_{IO}$        | Input offset current                            | $V_O = 0$ , $V_{CM} = 0$  | $T_A = 25^\circ\text{C}$                        |           | 25       | 150   | nA                           |
|                 |   |   | $T_A = -40^\circ\text{C}$ to $85^\circ\text{C}$ |           |          | 175   |                              |
| $V_{ICR}$       | Common-mode input voltage range                 | $\Delta V_{IO} = 5\text{ mV}$ , $V_O = 0$   |   | $\pm 13$  | $\pm 14$ |       | V                            |
| $A_{VD}$        | Large-signal differential voltage amplification | $R_L \geq 2\text{ k}\Omega$ , $V_O = \pm 10\text{ V}$                               | $T_A = 25^\circ\text{C}$                        | 90        | 110      |       | dB                           |
|                 |   |   | $T_A = -40^\circ\text{C}$ to $85^\circ\text{C}$ | 85        |          |       |                              |
| $V_{OM}$        | Maximum output voltage swing                    | $V_{ID} = \pm 1\text{ V}$   | $R_L = 600\ \Omega$                             | $V_{OM+}$ |          | 10.7  | V                            |
|                 |   |   |   | $V_{OM-}$ |          | -11.9 |                              |
|                 |   |   | $R_L = 2\text{ k}\Omega$                        | $V_{OM+}$ | 13.2     | 13.8  |                              |
|                 |   |   |   | $V_{OM-}$ | -13.2    | -13.7 |                              |
|                 |   |   | $R_L = 10\text{ k}\Omega$                       | $V_{OM+}$ | 13.5     | 14.1  |                              |
|                 |   |   |   | $V_{OM-}$ | -14      | -14.6 |                              |
| CMMR            | Common-mode rejection ratio                     | $V_{IN} = \pm 13\text{ V}$  |   | 80        | 100      |       | dB                           |
| $k_{SVR}^{(1)}$ | Supply-voltage rejection ratio                  | $V_{CC+} = 5\text{ V}$ to $15\text{ V}$ , $V_{CC-} = -5\text{ V}$ to $-15\text{ V}$ |   | 80        | 105      |       | dB                           |
| $I_{OS}$        | Output short-circuit current                    | $ V_{ID}  = 1\text{ V}$ , Output to GND   | Source current                                  | 15        | 29       |       | mA                           |
|                 |   |   | Sink current                                    | -20       | -37      |       |                              |
| $I_{CC}$        | Supply current (per channel)                    | $V_O = 0$   | $T_A = 25^\circ\text{C}$                        |           | 2.05     | 2.5   | mA                           |
|                 |   |   | $T_A = -40^\circ\text{C}$ to $85^\circ\text{C}$ |           |          | 2.75  |                              |

(1) Measured with  $V_{CC\pm}$  differentially varied at the same time

### Operating Characteristics

$V_{CC-} = -15\text{ V}$ ,  $V_{CC+} = 15\text{ V}$ ,  $T_A = 25^\circ\text{C}$  (unless otherwise noted)

| PARAMETER |                                | TEST CONDITIONS  |                       | MIN | TYP   | MAX | UNIT                   |
|-----------|--------------------------------|--|-----------------------|-----|-------|-----|------------------------|
| SR        | Slew rate at unity gain        | $A_{VD} = 1$ , $V_{IN} = -10\text{ V}$ to $10\text{ V}$ , $R_L = 2\text{ k}\Omega$ , $C_L = 100\text{ pF}$ |                       | 5   | 7     |     | V/ $\mu\text{s}$       |
| GBW       | Gain bandwidth product         | $f = 100\text{ kHz}$   |                       | 10  | 16    |     | MHz                    |
| $B_1$     | Unity gain frequency           | Open loop  |                       |     | 9     |     | MHz                    |
| $G_m$     | Gain margin                    | $R_L = 2\text{ k}\Omega$   | $C_L = 0\text{ pF}$   |     | -11   |     | dB                     |
|           |                                |  | $C_L = 100\text{ pF}$ |     | -6    |     |                        |
| $\Phi_m$  | Phase margin                   | $R_L = 2\text{ k}\Omega$   | $C_L = 0\text{ pF}$   |     | 55    |     | deg                    |
|           |                                |  | $C_L = 100\text{ pF}$ |     | 40    |     |                        |
|           | Amp-to-amp isolation           | $f = 20\text{ Hz}$ to $20\text{ kHz}$  |                       |     | -120  |     | dB                     |
|           | Power bandwidth                | $V_O = 27\text{ V}_{(PP)}$ , $R_L = 2\text{ k}\Omega$ , $\text{THD} \leq 1\%$                              |                       |     | 120   |     | kHz                    |
| THD       | Total harmonic distortion      | $V_O = 3\text{ V}_{rms}$ , $A_{VD} = 1$ , $R_L = 2\text{ k}\Omega$ , $f = 20\text{ Hz}$ to $20\text{ kHz}$ |                       |     | 0.002 |     | %                      |
| $Z_o$     | Open-loop output impedance     | $V_O = 0$ , $f = 9\text{ MHz}$   |                       |     | 37    |     | $\Omega$               |
| $r_{id}$  | Differential input resistance  | $V_{CM} = 0$   |                       |     | 175   |     | k $\Omega$             |
| $C_{id}$  | Differential input capacitance | $V_{CM} = 0$   |                       |     | 12    |     | pF                     |
| $V_n$     | Equivalent input noise voltage | $f = 1\text{ kHz}$ , $R_S = 100\ \Omega$   |                       |     | 4.5   |     | nV/ $\sqrt{\text{Hz}}$ |
| $I_n$     | Equivalent input noise current | $f = 1\text{ kHz}$   |                       |     | 0.5   |     | pA/ $\sqrt{\text{Hz}}$ |

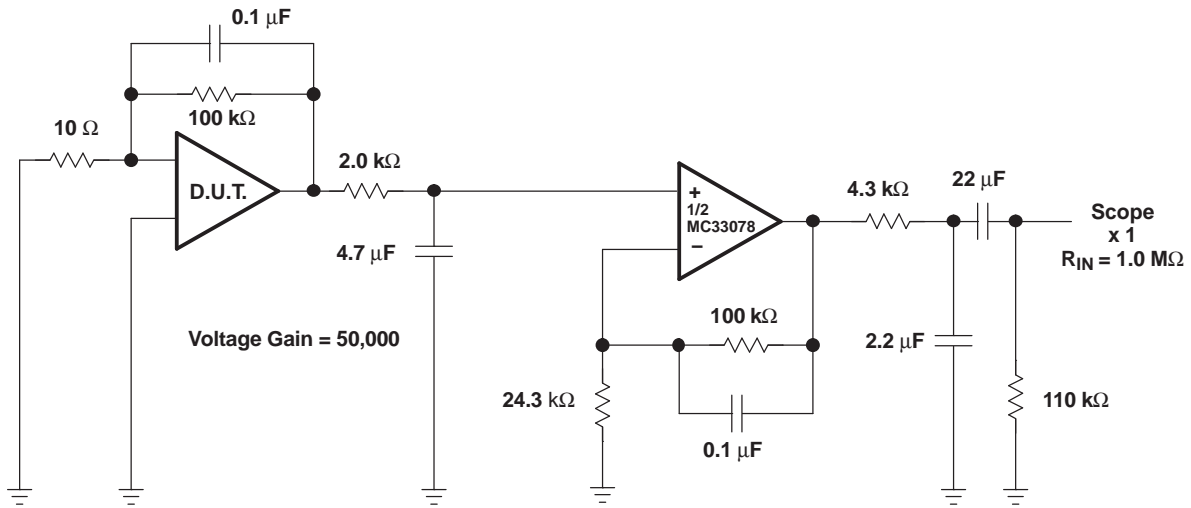

NOTE: All capacitors are non-polarized.

Figure 1. Voltage Noise Test Circuit (0.1 Hz to 10 Hz)

**TYPICAL CHARACTERISTICS**

**INPUT BIAS CURRENT**  
**VS**  
**COMMON-MODE VOLTAGE**

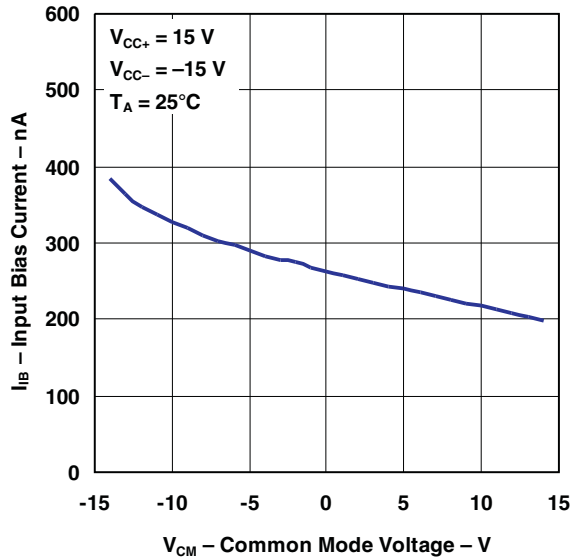

**INPUT BIAS CURRENT**  
**VS**  
**SUPPLY VOLTAGE**

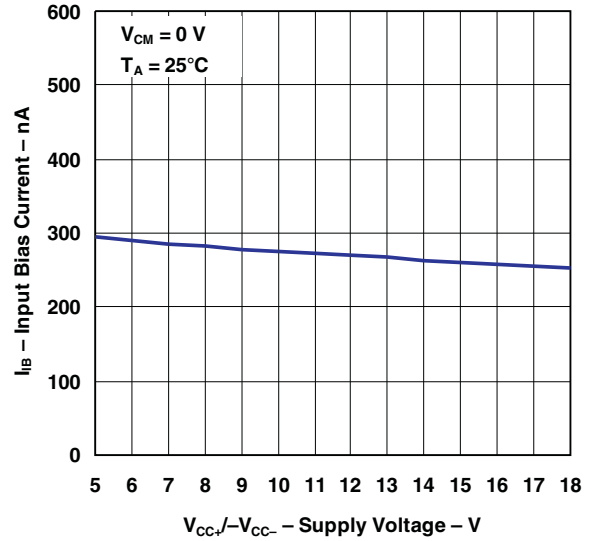

**INPUT BIAS CURRENT**  
**VS**  
**TEMPERATURE**

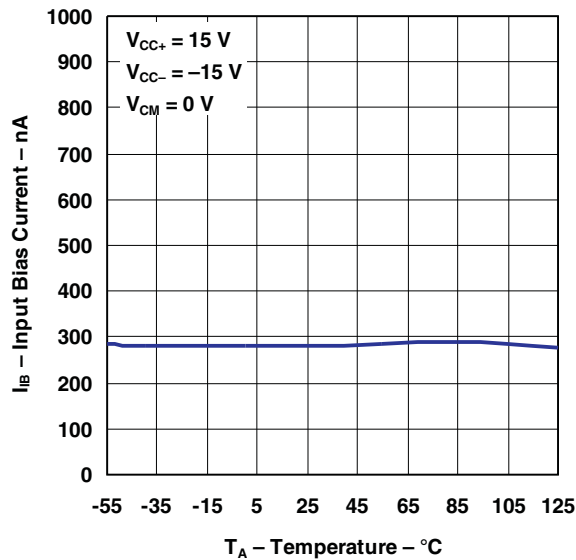

**INPUT OFFSET VOLTAGE**  
**VS**  
**TEMPERATURE**

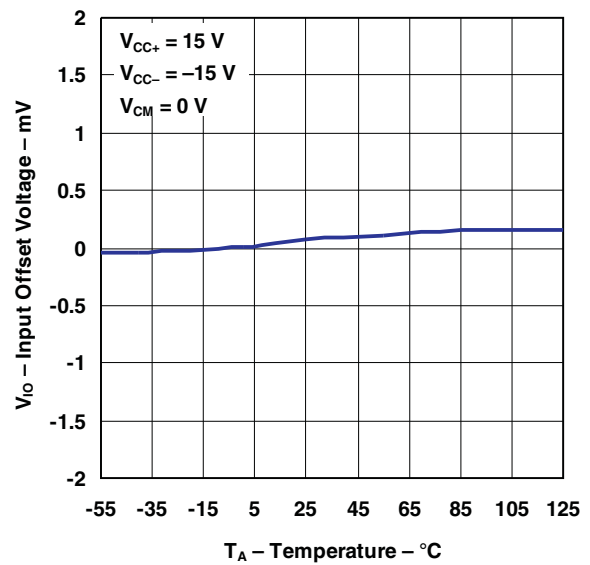

TYPICAL CHARACTERISTICS (continued)

INPUT COMMON-MODE VOLTAGE  
 LOW PROXIMITY TO  $V_{CC-}$   
 VS  
 TEMPERATURE

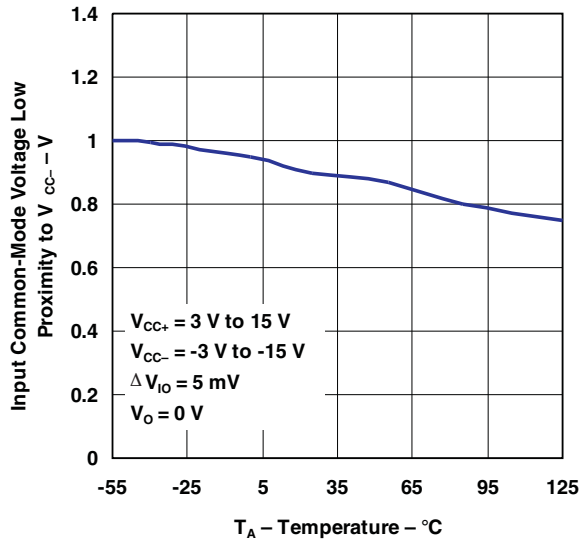

INPUT COMMON-MODE VOLTAGE  
 HIGH PROXIMITY TO  $V_{CC+}$   
 VS  
 TEMPERATURE

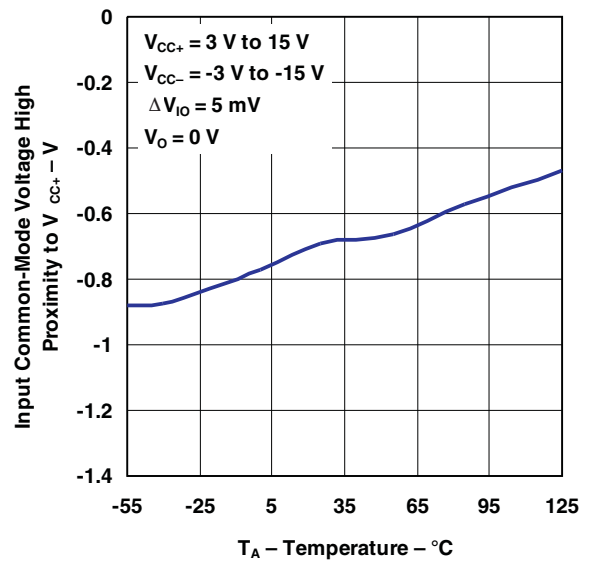

OUTPUT SATURATION VOLTAGE PROXIMITY TO  $V_{CC+}$   
 VS  
 LOAD RESISTANCE

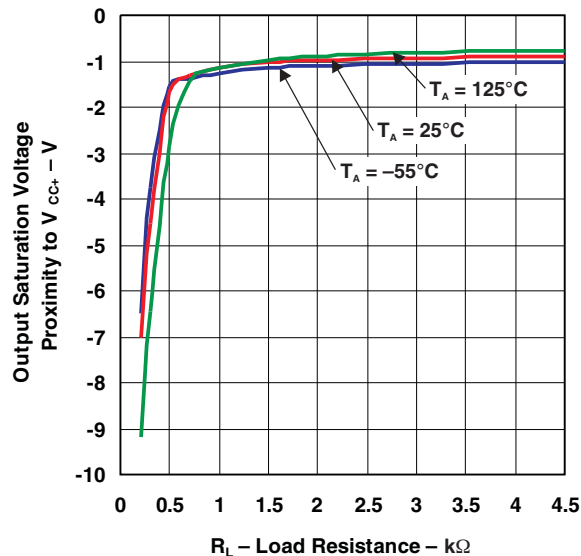

OUTPUT SATURATION VOLTAGE PROXIMITY TO  $V_{CC-}$   
 VS  
 LOAD RESISTANCE

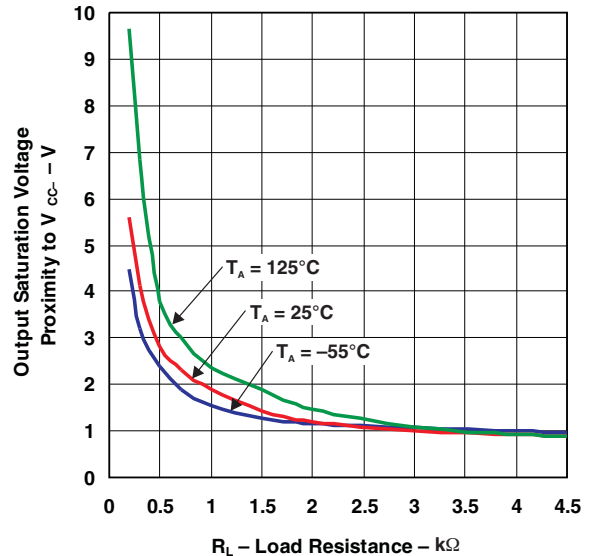

**TYPICAL CHARACTERISTICS (continued)**

**OUTPUT SHORT-CIRCUIT CURRENT  
VS  
TEMPERATURE**

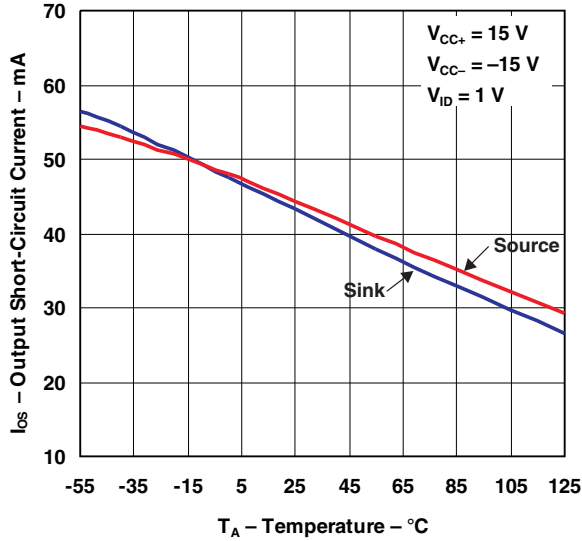

**SUPPLY CURRENT  
VS  
TEMPERATURE**

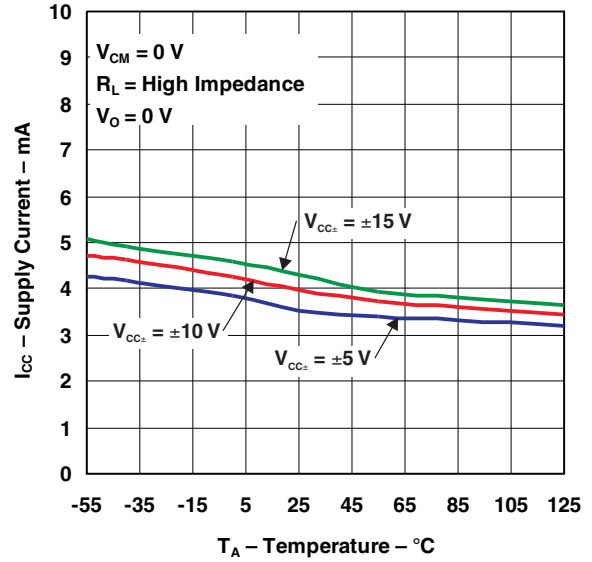

**CMRR  
VS  
FREQUENCY**

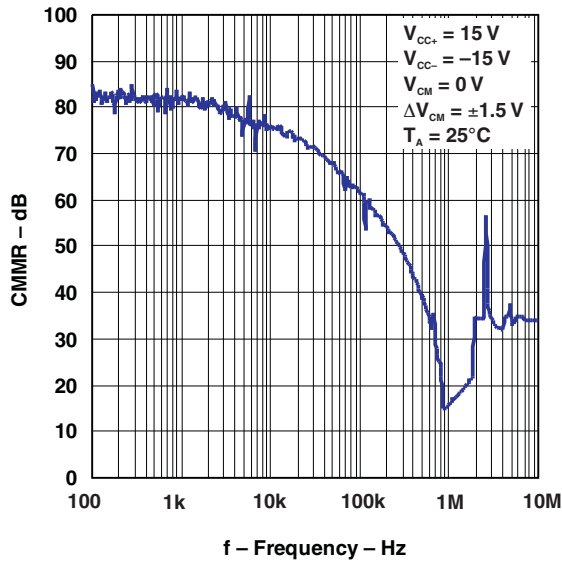

**PSSR  
VS  
FREQUENCY**

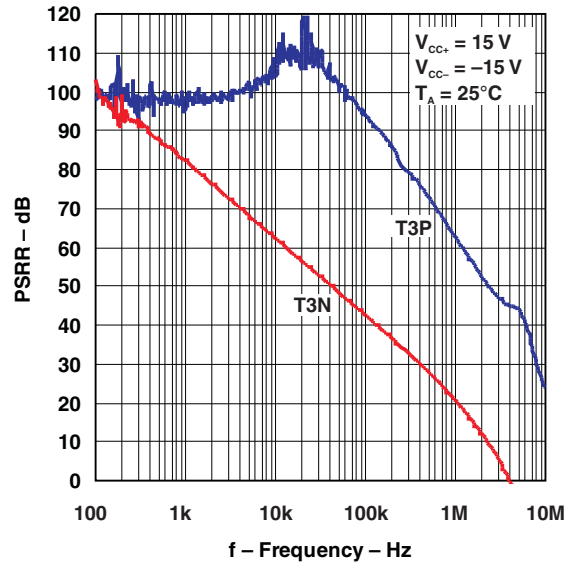

TYPICAL CHARACTERISTICS (continued)

GAIN BANDWIDTH PRODUCT  
 VS  
 SUPPLY VOLTAGE

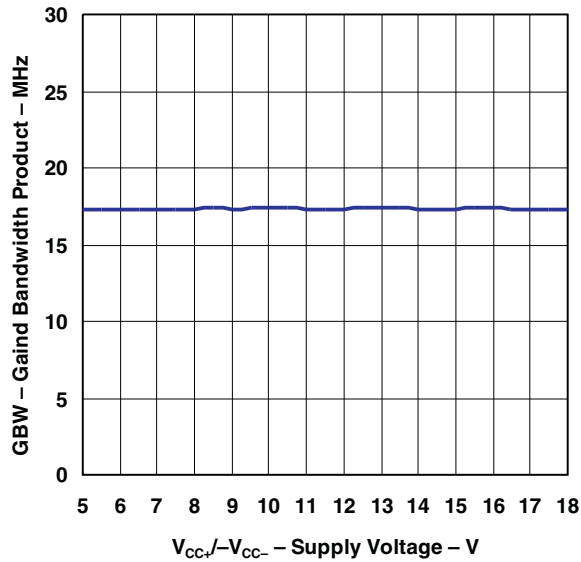

GAIN BANDWIDTH PRODUCT  
 VS  
 TEMPERATURE

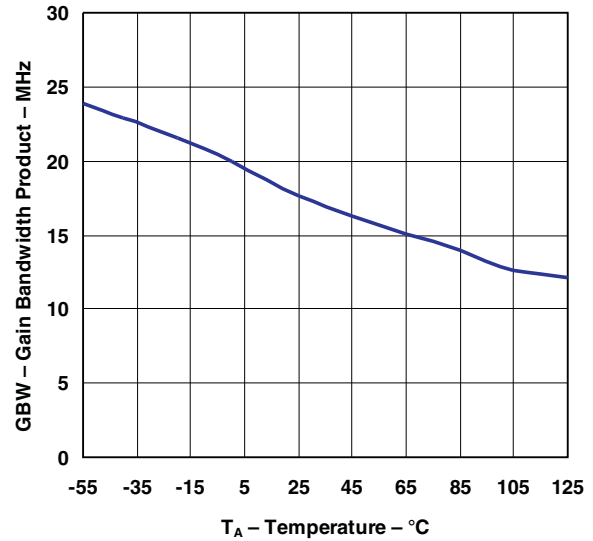

OUTPUT VOLTAGE  
 VS  
 SUPPLY VOLTAGE

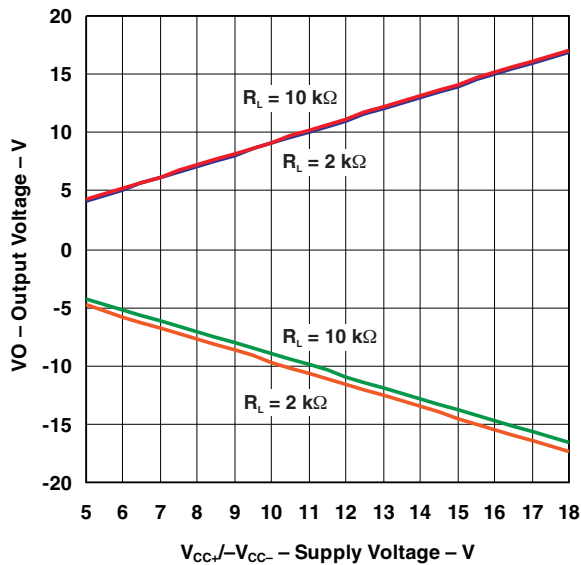

OUTPUT VOLTAGE  
 VS  
 FREQUENCY

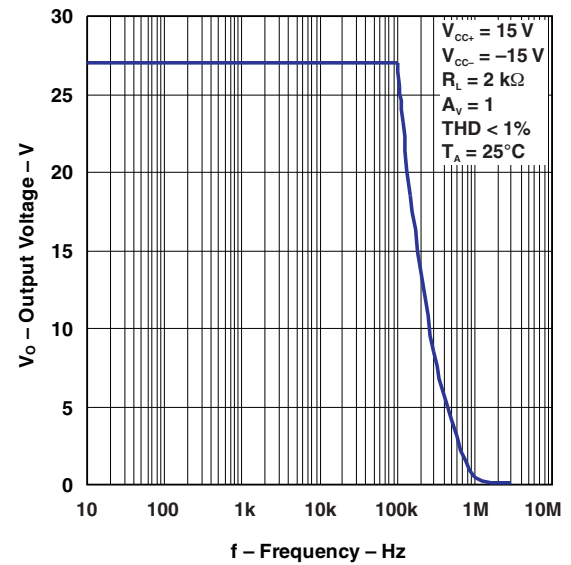

**TYPICAL CHARACTERISTICS (continued)**

**OPEN-LOOP GAIN**  
**VS**  
**SUPPLY VOLTAGE**

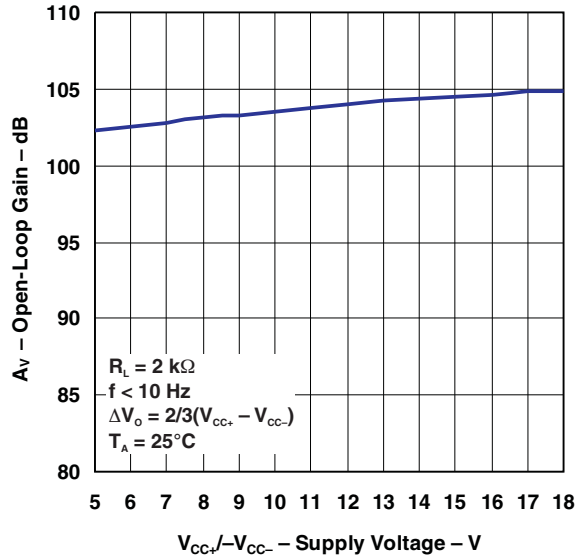

**OPEN-LOOP GAIN**  
**VS**  
**TEMPERATURE**

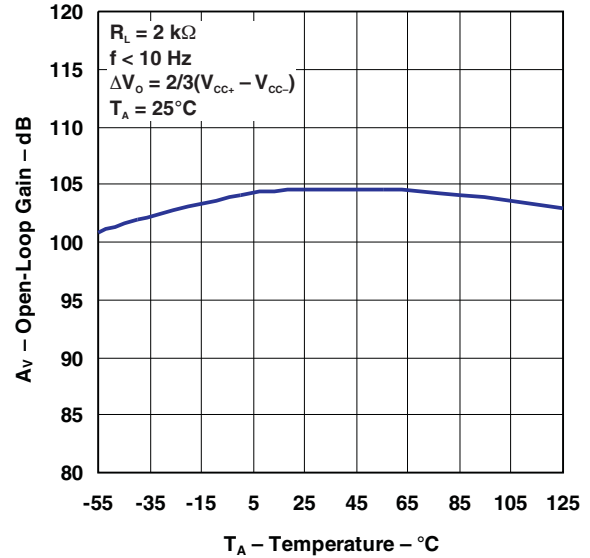

**OUTPUT IMPEDANCE**  
**VS**  
**FREQUENCY**

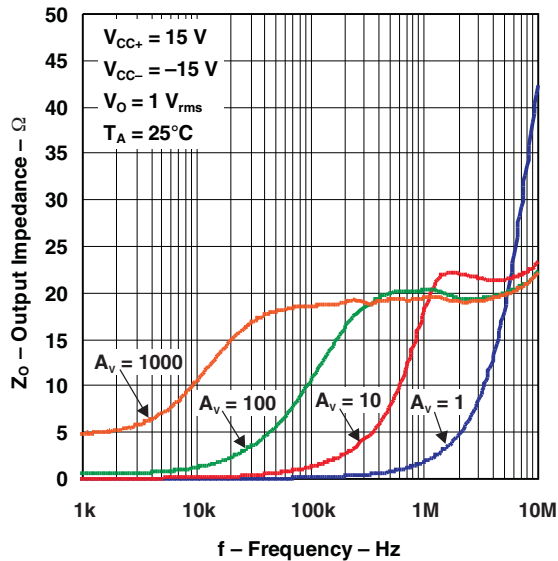

**CROSSTALK REJECTION**  
**VS**  
**FREQUENCY**

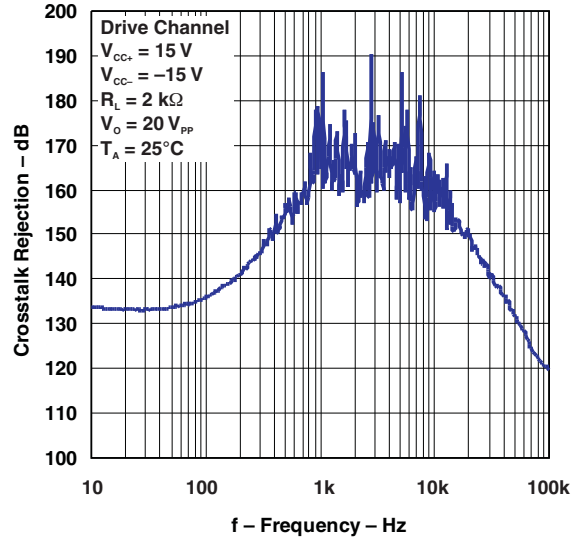

TYPICAL CHARACTERISTICS (continued)

TOTAL HARMONIC DISTORTION  
 VS  
 FREQUENCY

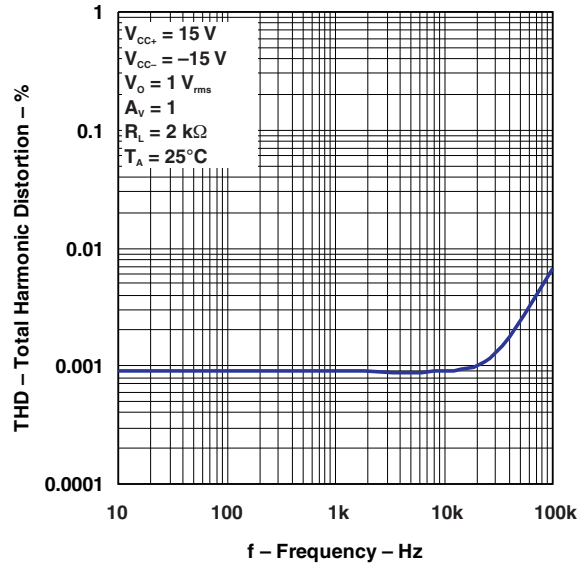

TOTAL HARMONIC DISTORTION  
 VS  
 OUTPUT VOLTAGE

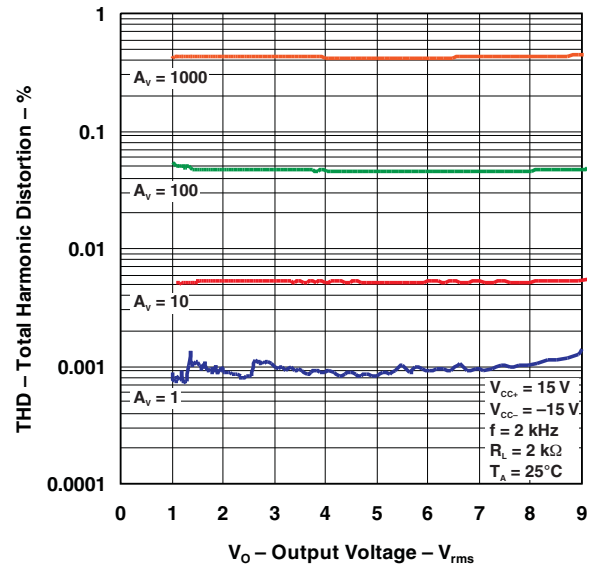

SLEW RATE  
 VS  
 SUPPLY VOLTAGE

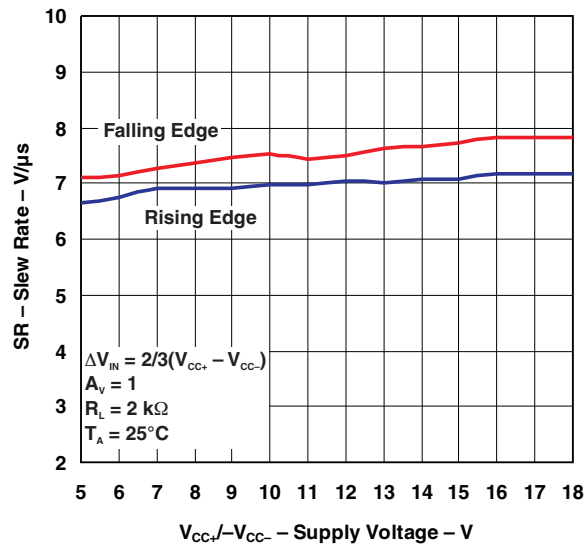

SLEW RATE  
 VS  
 TEMPERATURE

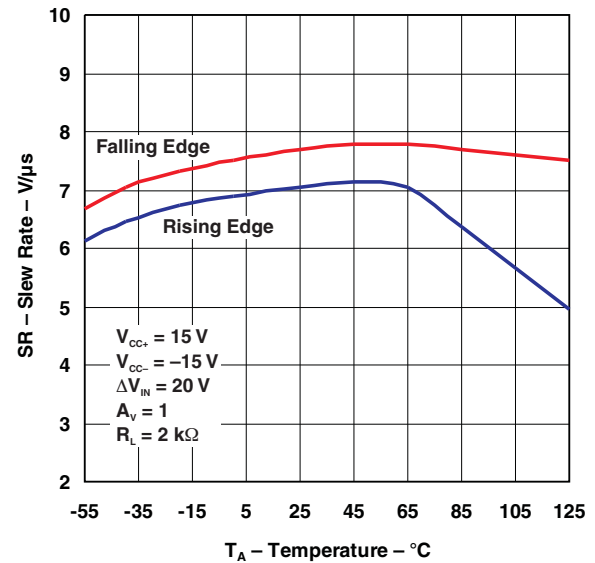

**TYPICAL CHARACTERISTICS (continued)**

**GAIN AND PHASE  
VS  
FREQUENCY**

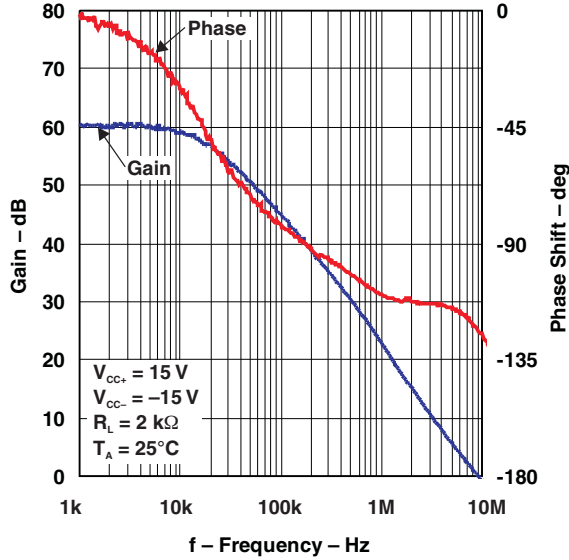

**GAIN AND PHASE MARGIN  
VS  
OUTPUT LOAD CAPACITANCE**

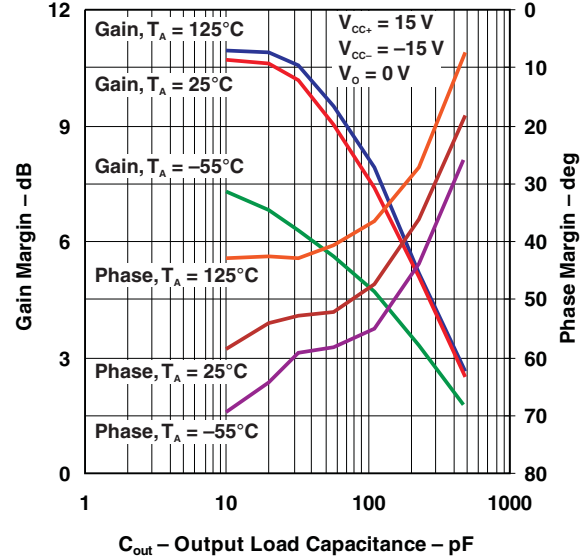

**OVERSHOOT  
VS  
OUTPUT LOAD CAPACITANCE**

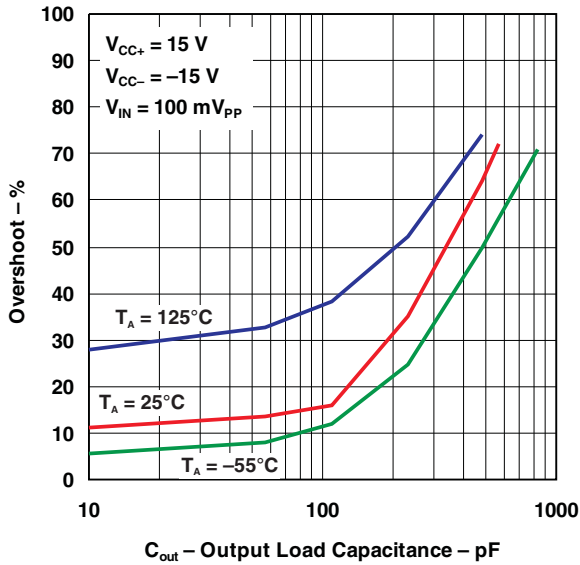

**INPUT VOLTAGE AND CURRENT NOISE  
VS  
FREQUENCY**

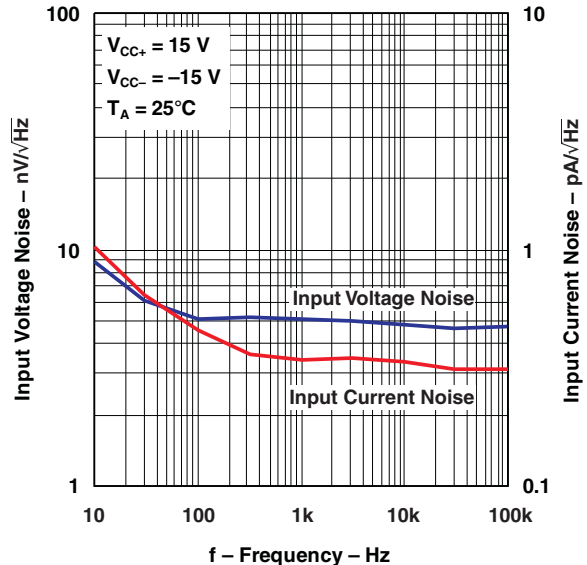

TYPICAL CHARACTERISTICS (continued)

INPUT REFERRED NOISE VOLTAGE  
 VS  
 SOURCE RESISTANCE

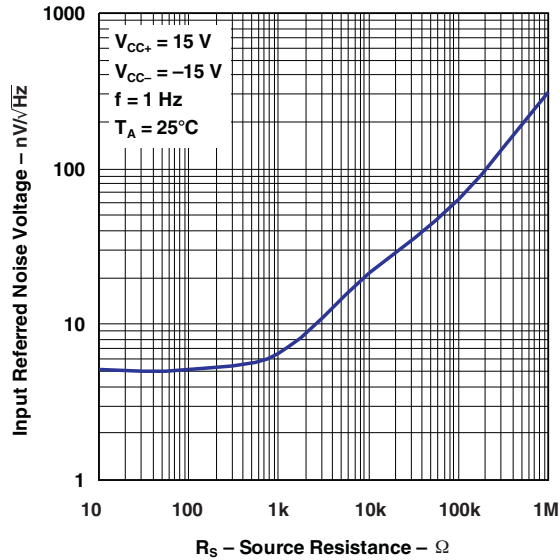

GAIN AND PHASE MARGIN  
 VS  
 DIFFERENTIAL SOURCE RESISTANCE

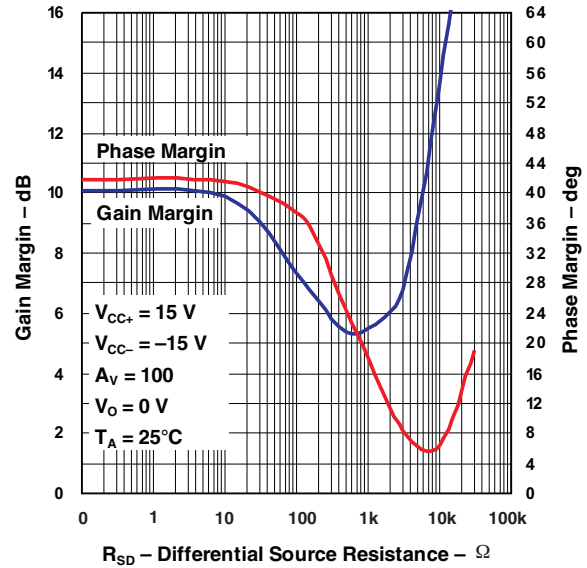

LARGE SIGNAL TRANSIENT RESPONSE  
 (AV = 1)

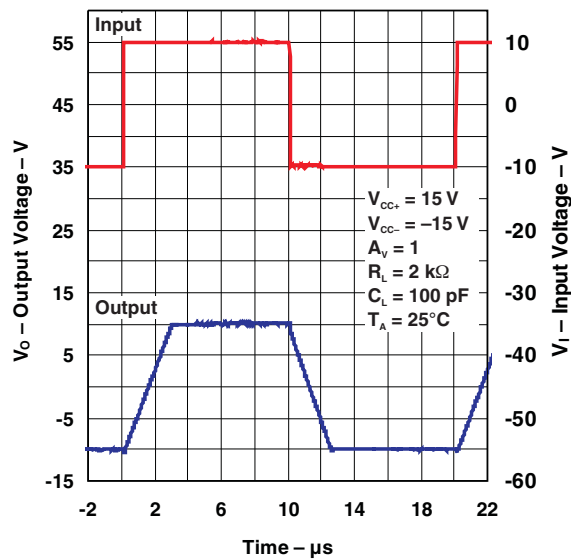

LARGE SIGNAL TRANSIENT RESPONSE  
 (AV = -1)

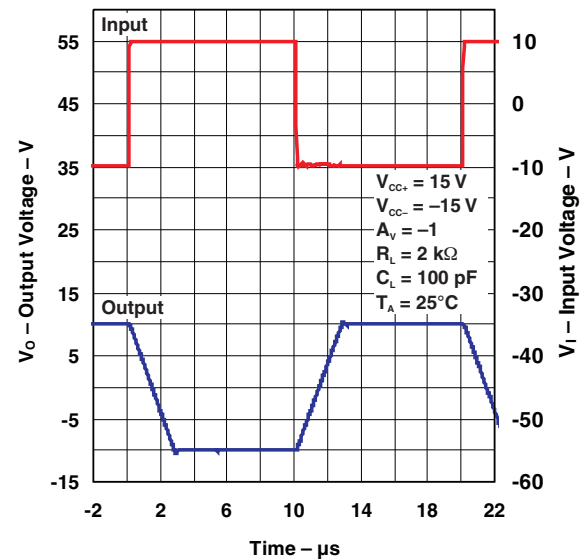

**TYPICAL CHARACTERISTICS (continued)**

**SMALL SIGNAL TRANSIENT RESPONSE**

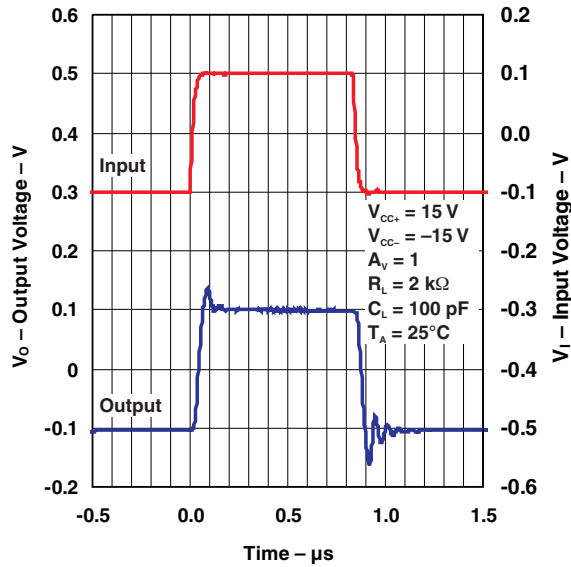

**LOW\_FREQUENCY NOISE**

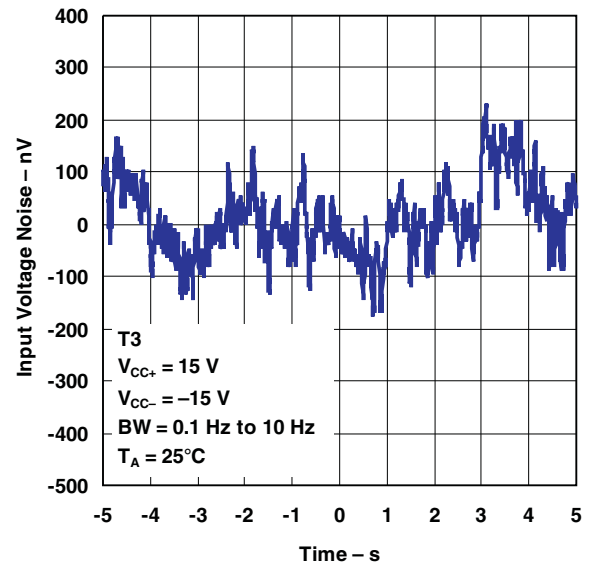

APPLICATION INFORMATION

Output Characteristics

All operating characteristics are specified with 100-pF load capacitance. The MC33078 can drive higher capacitance loads. However, as the load capacitance increases, the resulting response pole occurs at lower frequencies, causing ringing, peaking, or oscillation. The value of the load capacitance at which oscillation occurs varies from lot to lot. If an application appears to be sensitive to oscillation due to load capacitance, adding a small resistance in series with the load should alleviate the problem (see Figure 2).

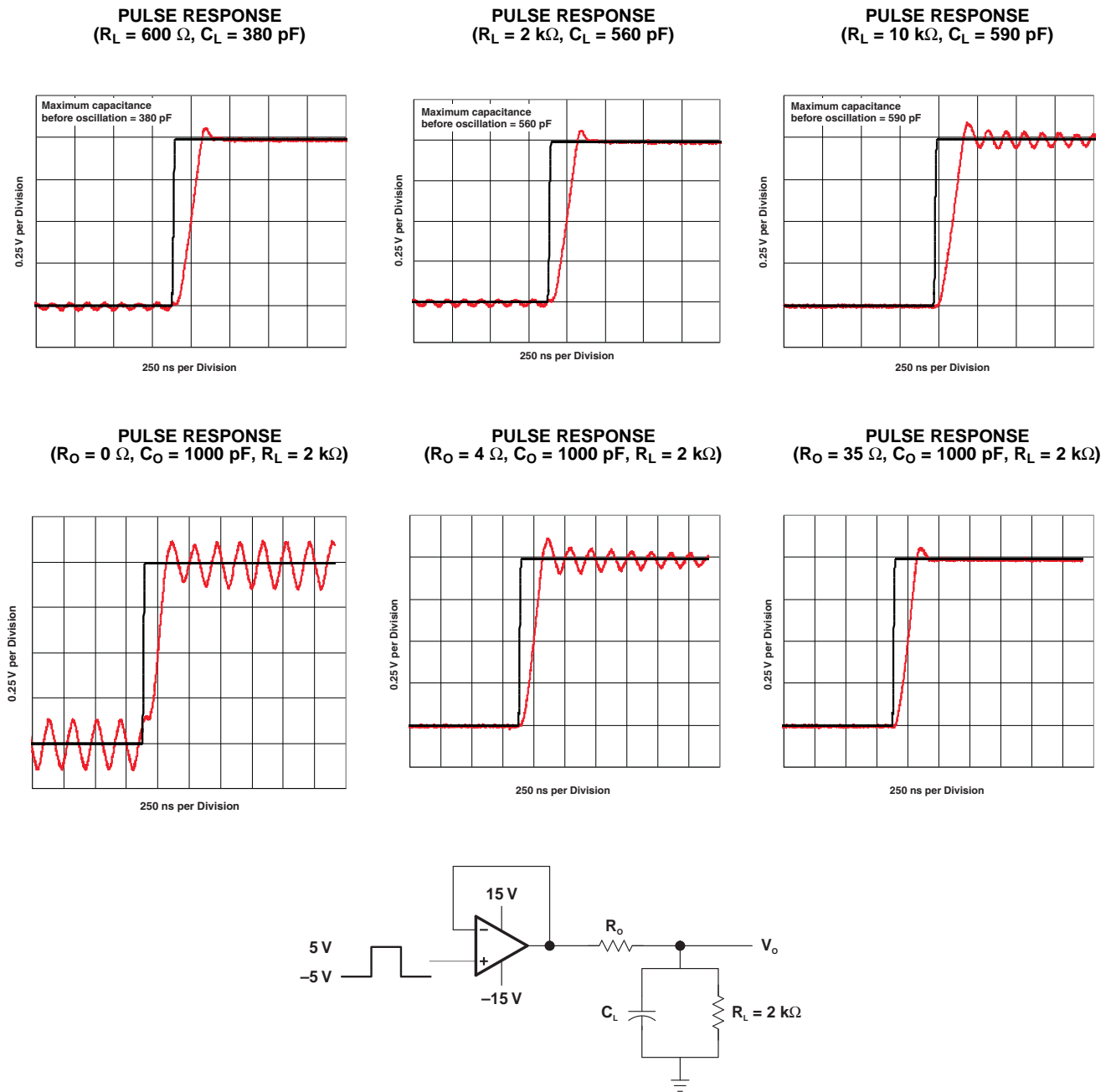

Figure 2. Output Characteristics

**PACKAGING INFORMATION**

| Orderable Device | Status<br>(1) | Package Type | Package Drawing | Pins | Package Qty | Eco Plan<br>(2)         | Lead/Ball Finish<br>(6) | MSL Peak Temp<br>(3) | Op Temp (°C) | Device Marking<br>(4/5) | Samples                 |
|------------------|---------------|--------------|-----------------|------|-------------|-------------------------|-------------------------|----------------------|--------------|-------------------------|-------------------------|
| MC33078D         | ACTIVE        | SOIC         | D               | 8    | 75          | Green (RoHS & no Sb/Br) | CU NIPDAU               | Level-1-260C-UNLIM   | -40 to 85    | M33078                  | <a href="#">Samples</a> |
| MC33078DG4       | ACTIVE        | SOIC         | D               | 8    | 75          | Green (RoHS & no Sb/Br) | CU NIPDAU               | Level-1-260C-UNLIM   | -40 to 85    | M33078                  | <a href="#">Samples</a> |
| MC33078DGKR      | ACTIVE        | VSSOP        | DGK             | 8    | 2500        | Green (RoHS & no Sb/Br) | CU NIPDAU               | Level-1-260C-UNLIM   | -40 to 85    | MYU                     | <a href="#">Samples</a> |
| MC33078DGKRG4    | ACTIVE        | VSSOP        | DGK             | 8    | 2500        | Green (RoHS & no Sb/Br) | CU NIPDAU               | Level-1-260C-UNLIM   | -40 to 85    | MYU                     | <a href="#">Samples</a> |
| MC33078DGKT      | ACTIVE        | VSSOP        | DGK             | 8    | 250         | Green (RoHS & no Sb/Br) | CU NIPDAU               | Level-1-260C-UNLIM   | -40 to 85    | MYU                     | <a href="#">Samples</a> |
| MC33078DR        | ACTIVE        | SOIC         | D               | 8    | 2500        | Green (RoHS & no Sb/Br) | CU NIPDAU               | Level-1-260C-UNLIM   | -40 to 85    | M33078                  | <a href="#">Samples</a> |
| MC33078DRE4      | ACTIVE        | SOIC         | D               | 8    | 2500        | Green (RoHS & no Sb/Br) | CU NIPDAU               | Level-1-260C-UNLIM   | -40 to 85    | M33078                  | <a href="#">Samples</a> |
| MC33078P         | ACTIVE        | PDIP         | P               | 8    | 50          | Green (RoHS & no Sb/Br) | CU NIPDAU               | N / A for Pkg Type   | -40 to 85    | MC33078P                | <a href="#">Samples</a> |

(1) The marketing status values are defined as follows:

**ACTIVE:** Product device recommended for new designs.

**LIFEBUY:** TI has announced that the device will be discontinued, and a lifetime-buy period is in effect.

**NRND:** Not recommended for new designs. Device is in production to support existing customers, but TI does not recommend using this part in a new design.

**PREVIEW:** Device has been announced but is not in production. Samples may or may not be available.

**OBSOLETE:** TI has discontinued the production of the device.

(2) **RoHS:** TI defines "RoHS" to mean semiconductor products that are compliant with the current EU RoHS requirements for all 10 RoHS substances, including the requirement that RoHS substance do not exceed 0.1% by weight in homogeneous materials. Where designed to be soldered at high temperatures, "RoHS" products are suitable for use in specified lead-free processes. TI may reference these types of products as "Pb-Free".

**RoHS Exempt:** TI defines "RoHS Exempt" to mean products that contain lead but are compliant with EU RoHS pursuant to a specific EU RoHS exemption.

**Green:** TI defines "Green" to mean the content of Chlorine (Cl) and Bromine (Br) based flame retardants meet JS709B low halogen requirements of <=1000ppm threshold. Antimony trioxide based flame retardants must also meet the <=1000ppm threshold requirement.

(3) MSL, Peak Temp. - The Moisture Sensitivity Level rating according to the JEDEC industry standard classifications, and peak solder temperature.

(4) There may be additional marking, which relates to the logo, the lot trace code information, or the environmental category on the device.

(5) Multiple Device Markings will be inside parentheses. Only one Device Marking contained in parentheses and separated by a "-" will appear on a device. If a line is indented then it is a continuation of the previous line and the two combined represent the entire Device Marking for that device.

(6) Lead/Ball Finish - Orderable Devices may have multiple material finish options. Finish options are separated by a vertical ruled line. Lead/Ball Finish values may wrap to two lines if the finish value exceeds the maximum column width.

**Important Information and Disclaimer:**The information provided on this page represents TI's knowledge and belief as of the date that it is provided. TI bases its knowledge and belief on information provided by third parties, and makes no representation or warranty as to the accuracy of such information. Efforts are underway to better integrate information from third parties. TI has taken and continues to take reasonable steps to provide representative and accurate information but may not have conducted destructive testing or chemical analysis on incoming materials and chemicals. TI and TI suppliers consider certain information to be proprietary, and thus CAS numbers and other limited information may not be available for release.

In no event shall TI's liability arising out of such information exceed the total purchase price of the TI part(s) at issue in this document sold by TI to Customer on an annual basis.

**OTHER QUALIFIED VERSIONS OF MC33078 :**

- Enhanced Product: [MC33078-EP](#)

NOTE: Qualified Version Definitions:

- Enhanced Product - Supports Defense, Aerospace and Medical Applications

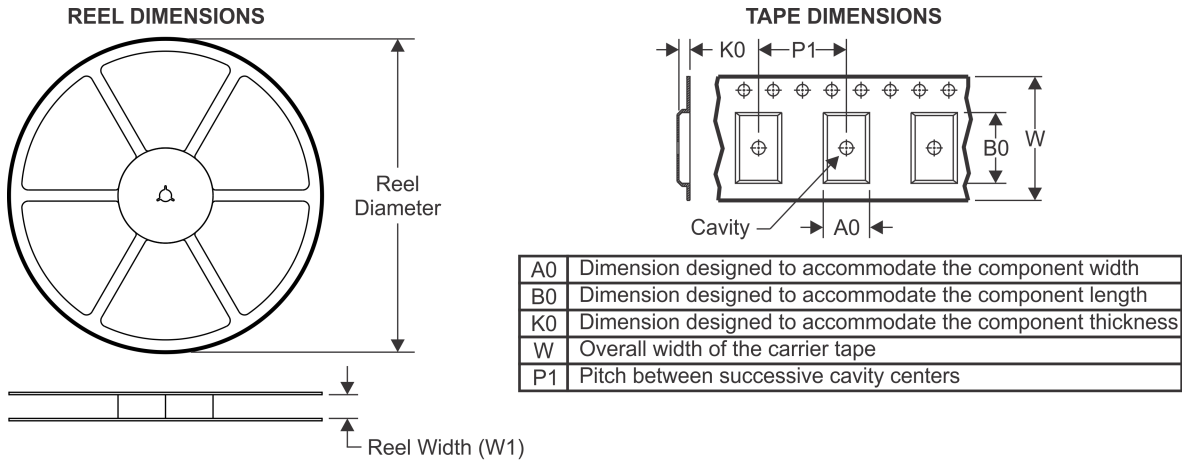
**TAPE AND REEL INFORMATION**

**QUADRANT ASSIGNMENTS FOR PIN 1 ORIENTATION IN TAPE**

\*All dimensions are nominal

| Device      | Package Type | Package Drawing | Pins | SPQ  | Reel Diameter (mm) | Reel Width W1 (mm) | A0 (mm) | B0 (mm) | K0 (mm) | P1 (mm) | W (mm) | Pin1 Quadrant |
|-------------|--------------|-----------------|------|------|--------------------|--------------------|---------|---------|---------|---------|--------|---------------|
| MC33078DGKR | VSSOP        | DGK             | 8    | 2500 | 330.0              | 12.4               | 5.3     | 3.3     | 1.3     | 8.0     | 12.0   | Q1            |
| MC33078DGKT | VSSOP        | DGK             | 8    | 250  | 180.0              | 12.4               | 5.3     | 3.3     | 1.3     | 8.0     | 12.0   | Q1            |
| MC33078DR   | SOIC         | D               | 8    | 2500 | 330.0              | 12.4               | 6.4     | 5.2     | 2.1     | 8.0     | 12.0   | Q1            |
| MC33078DR   | SOIC         | D               | 8    | 2500 | 330.0              | 12.4               | 6.4     | 5.2     | 2.1     | 8.0     | 12.0   | Q1            |

**TAPE AND REEL BOX DIMENSIONS**

\*All dimensions are nominal

| Device      | Package Type | Package Drawing | Pins | SPQ  | Length (mm) | Width (mm) | Height (mm) |
|-------------|--------------|-----------------|------|------|-------------|------------|-------------|
| MC33078DGKR | VSSOP        | DGK             | 8    | 2500 | 346.0       | 346.0      | 35.0        |
| MC33078DGKT | VSSOP        | DGK             | 8    | 250  | 220.0       | 205.0      | 50.0        |
| MC33078DR   | SOIC         | D               | 8    | 2500 | 340.5       | 338.1      | 20.6        |
| MC33078DR   | SOIC         | D               | 8    | 2500 | 367.0       | 367.0      | 35.0        |



# EXAMPLE BOARD LAYOUT

D0008A

SOIC - 1.75 mm max height

SMALL OUTLINE INTEGRATED CIRCUIT



LAND PATTERN EXAMPLE  
 EXPOSED METAL SHOWN  
 SCALE:8X



SOLDER MASK DETAILS

4214825/C 02/2019

NOTES: (continued)

- 6. Publication IPC-7351 may have alternate designs.
- 7. Solder mask tolerances between and around signal pads can vary based on board fabrication site.

# EXAMPLE STENCIL DESIGN

D0008A

SOIC - 1.75 mm max height

SMALL OUTLINE INTEGRATED CIRCUIT



SOLDER PASTE EXAMPLE  
BASED ON .005 INCH [0.125 MM] THICK STENCIL  
SCALE:8X

4214825/C 02/2019

NOTES: (continued)

8. Laser cutting apertures with trapezoidal walls and rounded corners may offer better paste release. IPC-7525 may have alternate design recommendations.
9. Board assembly site may have different recommendations for stencil design.

P (R-PDIP-T8)

PLASTIC DUAL-IN-LINE PACKAGE



- NOTES:
- A. All linear dimensions are in inches (millimeters).
  - B. This drawing is subject to change without notice.
  - C. Falls within JEDEC MS-001 variation BA.

DGK (S-PDSO-G8)

PLASTIC SMALL-OUTLINE PACKAGE

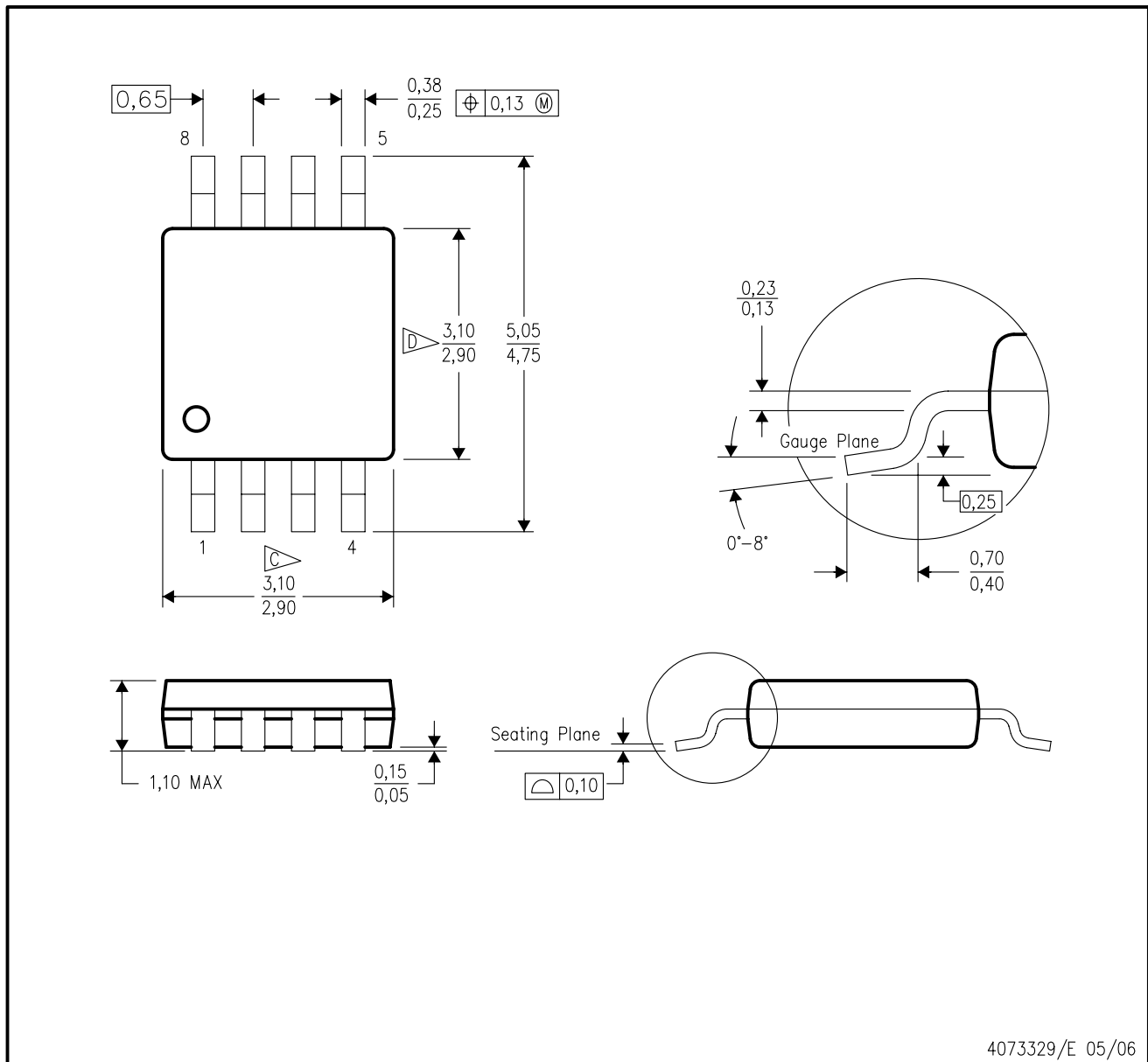

- NOTES:
- A. All linear dimensions are in millimeters.
  - B. This drawing is subject to change without notice.
  - C. Body length does not include mold flash, protrusions, or gate burrs. Mold flash, protrusions, or gate burrs shall not exceed 0.15 per end.
  - D. Body width does not include interlead flash. Interlead flash shall not exceed 0.50 per side.
  - E. Falls within JEDEC MO-187 variation AA, except interlead flash.



- NOTES:
- A. All linear dimensions are in millimeters.
  - B. This drawing is subject to change without notice.
  - C. Publication IPC-7351 is recommended for alternate designs.
  - D. Laser cutting apertures with trapezoidal walls and also rounding corners will offer better paste release. Customers should contact their board assembly site for stencil design recommendations. Refer to IPC-7525 for other stencil recommendations.
  - E. Customers should contact their board fabrication site for solder mask tolerances between and around signal pads.

## IMPORTANT NOTICE AND DISCLAIMER

TI PROVIDES TECHNICAL AND RELIABILITY DATA (INCLUDING DATASHEETS), DESIGN RESOURCES (INCLUDING REFERENCE DESIGNS), APPLICATION OR OTHER DESIGN ADVICE, WEB TOOLS, SAFETY INFORMATION, AND OTHER RESOURCES "AS IS" AND WITH ALL FAULTS, AND DISCLAIMS ALL WARRANTIES, EXPRESS AND IMPLIED, INCLUDING WITHOUT LIMITATION ANY IMPLIED WARRANTIES OF MERCHANTABILITY, FITNESS FOR A PARTICULAR PURPOSE OR NON-INFRINGEMENT OF THIRD PARTY INTELLECTUAL PROPERTY RIGHTS.

These resources are intended for skilled developers designing with TI products. You are solely responsible for (1) selecting the appropriate TI products for your application, (2) designing, validating and testing your application, and (3) ensuring your application meets applicable standards, and any other safety, security, or other requirements. These resources are subject to change without notice. TI grants you permission to use these resources only for development of an application that uses the TI products described in the resource. Other reproduction and display of these resources is prohibited. No license is granted to any other TI intellectual property right or to any third party intellectual property right. TI disclaims responsibility for, and you will fully indemnify TI and its representatives against, any claims, damages, costs, losses, and liabilities arising out of your use of these resources.

TI's products are provided subject to TI's Terms of Sale ([www.ti.com/legal/termsofsale.html](http://www.ti.com/legal/termsofsale.html)) or other applicable terms available either on [ti.com](http://ti.com) or provided in conjunction with such TI products. TI's provision of these resources does not expand or otherwise alter TI's applicable warranties or warranty disclaimers for TI products.

Mailing Address: Texas Instruments, Post Office Box 655303, Dallas, Texas 75265  
Copyright © 2019, Texas Instruments Incorporated

## Looking for pricing, stock, or lifecycle information?

Click below to explore more details on WIN SOURCE:

 [View MC33078DRE4](#) on WIN SOURCE

 [Texas Instruments](#) Information

## Optimize Your Supply Chain with WIN SOURCE Solutions

-  Global Sourcing Solution
-  Obsolete Management
-  Cost Control Management
-  Shortage Management
-  Alternative Solution
-  Excess Inventory Management