

F32

Conductive Polymer
Resin-molded Chip

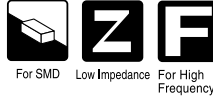

● Adapted to the RoHS directive (2002/95/EC).



■ Type numbering system (Example : 6.3V 100μF)

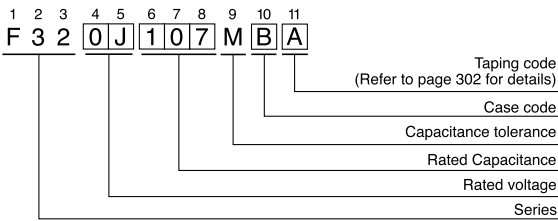

■ Dimensions

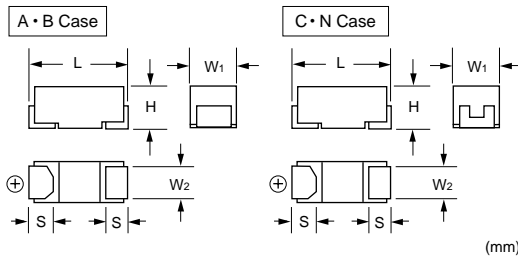

Case code	L	W ₁	W ₂	H	S
A	3.2±0.2	1.6±0.2	1.2±0.1	1.6±0.2	0.8±0.2
B	3.5±0.2	2.8±0.2	2.2±0.1	1.9±0.2	0.8±0.2
C	6.0±0.2	3.2±0.2	2.2±0.1	2.5±0.2	1.3±0.2
N	7.3±0.2	4.3±0.2	2.4±0.1	2.8±0.2	1.3±0.2

■ Marking

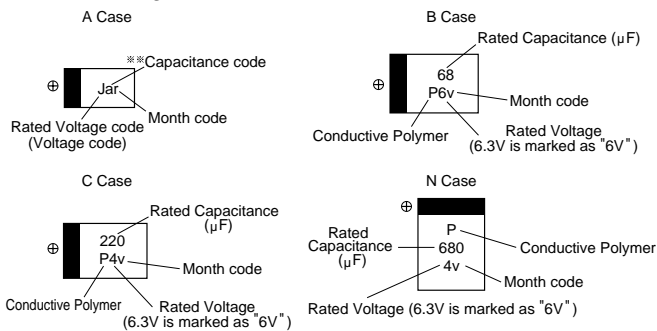

■ Standard ratings

Cap. (μF)	V				Capacitance code
	2.5	4	6.3	10	
10	226			A	a
22	226			A	J
33	336		A	A	n
47	476	A	A	B	s
68	686	A	B		w
100	107	B	B	C	
150	157	B	(B) · C	C	
220	227	B	(B) · C	N	N
330	337	(B) · C	C	N	
680	687		N		
1000	108	N			

■ Specifications

Item	Performance Characteristics
Category Temperature Range	-55 to +105°C (Rated temperature + 85°C)
Capacitance Tolerance	±20% (120Hz)
Dissipation Factor(at 120Hz)	Refer to the list below
ESR (100kHz)	Refer to the list below
Leakage Current	· After 5 minutes' application of rated voltage, leakage current at 20°C is not more than 0.1CV
Ripple Current	Refer to the list below
Damp Heat (Steady State)	At 60°C, 90 to 95% R.H. 500hours (No voltage applied) Capacitance Change-Within ±20% of initial value Dissipation Factor-.....1.5 times Initial specified value or less Leakage Current-.....Initial specified value or less
Temperature Cycles	-55°C / +105°C 30 minutes each 5 cycle Capacitance Change-Within ±20% of initial value Dissipation Factor-.....Initial specified value or less Leakage Current-.....Initial specified value or less
Resistance to Soldering Heat	Test Condition:10 second reflow at 240°C Capacitance Change-Within ±20% of initial value Dissipation Factor-.....1.3 times Initial specified value or less Leakage Current-.....Initial specified value or less
Surge	After application of surge voltage in series with a 1kΩ resistor at the rate of 30 seconds ON, 30 seconds OFF, for 1000 successive test cycles at 85°C, capacitors meet the characteristics requirements listed below. Capacitance Change-Within ±20% of initial value Dissipation Factor-.....Initial specified value or less Leakage Current-.....Initial specified value or less
Endurance 1	After 1000 hours' application of rated voltage in series with a 3Ω resistor at 85°C. Capacitance Change-Within ±20% of initial value Dissipation Factor-.....1.5 times Initial specified value or less Leakage Current-.....Initial specified value or less
Endurance 2	After 1000 hours' application of rated voltage in series with a 3Ω resistor at 105°C, capacitors meet the characteristic requirements listed below Capacitance Change-Within ±20% of initial value Dissipation Factor-.....3 times Initial specified value or less Leakage Current-.....Initial specified value or less
Shear Test	After applying the pressure load of 5N for 10±1 seconds horizontally to the center of capacitor side body which has no electrode and has been soldered beforehand on an aluminum substrate, there shall be found neither exfoliation nor its sign at the terminal electrode.
Terminal Strength	Keeping a capacitor surface-mounted on a substrate upside down and supporting the substrate at both of the opposite bottom points 45mm apart from the center of the capacitor, the pressure strength is applied with a specified jig at the center of the substrate so that the substrate may bend by 1mm as illustrated. Then, there shall be found no remarkable abnormality on the capacitor terminals.

* As for the surge voltage refer to page 301 for details.

■ Standard ratings

Rated Volt (V)	Rated Capacitance (μF)	Case code	Part Number	Leakage Current (μA)	Dissipation Factor (%@120Hz)	ESR (mΩ@100kHz)	Rated Ripple (mArms@100kHz)
2.5	220	B	F320E227MBA	55.0	8	45 (35)*	1374
	330	N	F320E337MCC	82.5	10	55 (45)*	1414
	1000	N	F320E108MNC	250	10	25	2449
4	47	A	F320G476MAA	18.8	6	180	645
	68	A	F320G686MAA	27.2	6	180	645
	100	B	F320G107MBA	40.0	8	70 (45,35)*	1102
	150	B	F320G157MBA	60.0	8	45 (35)*	1374
	220	C	F320G227MCC	88.0	8	55 (45)*	1414
	330	C	F320G337MCC	132	10	55	1414
	680	N	F320G687MNC	272	10	25	2449
6.3	33	A	F320J336MAA	21	6	180	645
	47	A	F320J476MAA	29.6	6	180	645
	68	B	F320J686MBA	42.9	8	70	1102
	100	B	F320J107MBA	63.0	8	70 (45,35)*	1102
	150	C	F320J157MCC	94.5	9	100 (55,45)*	1049
	220	N	F320J227MNC	139	10	55 (40)*	1651
10	330	N	F320J337MNC	208	10	40 (25)*	1936
	10	A	F321A106MAA	10	6	180	645
	22	A	F321A226MAA	22.0	6	180	645
	33	A	F321A336MAA	33.0	6	200	612
	47	B	F321A476MBA	47.0	8	70	1102
	100	C	F321A107MCC	100	9	55	1414
150	150	C	F321A157MCC	150	9	55	1414
	220	N	F321A227MNC	220	10	55 (40,25)*	1651

* () ESR specification types are also available upon request.

Please contact to your local Nichicon sales office when these series are being designed in your application.



Looking for pricing, stock, or lifecycle information?

Click below to explore more details on WIN SOURCE:

 [View F320J476MAA](#) on WIN SOURCE

 [Nichicon](#) Information

Optimize Your Supply Chain with WIN SOURCE Solutions

-  Global Sourcing Solution
-  Obsolete Management
-  Cost Control Management
-  Shortage Management
-  Alternative Solution
-  Excess Inventory Management