



THE DATASHEET OF SCS106AGC





Innovations Embedded

Silicon Carbide
Schottky Barrier Diodes

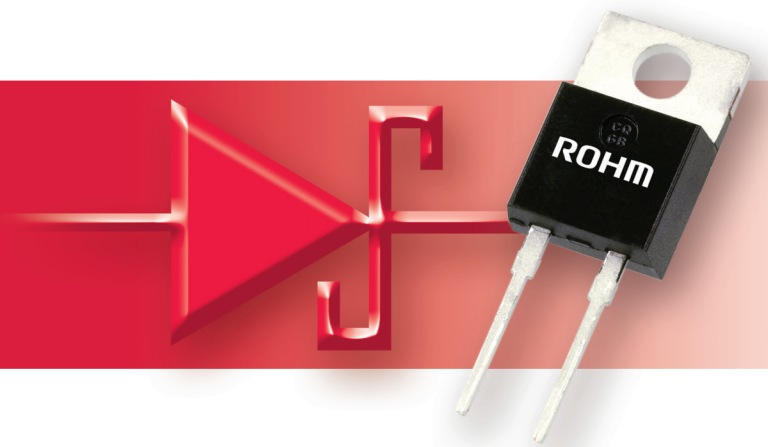

Silicon Carbide Schottky Barrier Diodes

Taking Efficiency to the Next Level for PFC and Other Applications

Introduction

The semiconductor industry has a well-established history of “smaller, faster, and cheaper.” Improving performance and reducing device cost while shrinking packaging size is fundamental to virtually every semiconductor product type. For power products, improved performance is measured by increased efficiency and power density, higher power handling capability, and wider operating temperature range. Such improvements depend largely on the desirable characteristics of power components used, such as low switching and conduction losses, high switching frequency, stable electrical characteristics over a wide temperature range, high operating temperature, and high blocking voltage. As silicon power components approach their theoretical limits, compound semiconductor materials, such as silicon carbide (SiC) and gallium nitride (GaN), provide the capability to dramatically improve these parameters.

Today, the need for higher efficiency in end products is more critical than ever. Although silicon power products continue to see incremental improvements, devices based on compound semiconductor materials deliver significantly better performance — in a large number of cases not possible with their silicon counterparts. This is certainly true for the most basic components in power electronics: diodes and transistors. Silicon carbide (SiC)

Schottky barrier diodes (SBDs) have been available for more than a decade but were not commercially viable until recently. As a pioneer in SiC technology, ROHM Semiconductor expects that volume production will lead to SiC’s acceptance in more and more applications.

The Advantages of Silicon Carbide

The highest performance silicon power diodes are Schottky barrier diodes. Not only do SBDs have the lowest reverse recovery time (t_{rr}) compared to the various types of fast recovery (fast recovery epitaxial), ultrafast recovery and super-fast recovery diodes, they also have the lowest forward voltage drop (V_F). Both of these parameters are essential to high efficiency. Table 1 shows a comparison of breakdown voltage, V_F , and t_{rr} for commonly available diodes. While Schottky barrier diodes have the advantage of low forward losses and negligible switching losses compared to other diode technologies, the narrow bandgap of silicon limits their use to a maximum voltage of around 200 V. Si diodes that operate above 200 V have higher V_F and t_{rr} .

Silicon carbide is a compound semiconductor with superior power characteristics to silicon, including a bandgap approximately three times greater, a dielectric breakdown field 10 times higher and a thermal coefficient three times larger. These characteristics make it

Type	VBR (VRRM)	V_F (1)	t_{rr} (1)
Si Schottky Barrier Diode	15 V-200 V	0.3V-0.8 V	<10 ns
Si Super Fast Diode	50 V-600 V	0.8V-1.2 V	25 ns-35 ns
Si Ultra Fast Diode	50 V-1,000 V	1.35V-1.75 V	50 ns-75 ns
Si Fast Recovery (Epitaxial) Diode	50 V-1,000 V	1.2 V	100 ns-500 ns
Si Standard Recovery Diode	50 V-1,000 V	1.0 V	1 μ s-2 μ s
Silicon Carbide Schottky Barrier Diode	600 V	1.5 V	<15 ns

(1) @25°C. Si-based diodes have a wide increase at higher temperatures and are typically limited to 150°C operation.

Table 1. Comparison of key parameters for silicon and SiC diodes.

ideal for power electronics applications. Silicon carbide devices have higher breakdown voltage, operating temperature and thermal conductivity, as well as shorter recovery time and lower reverse current than silicon diodes with comparable breakdown voltage. These device characteristics equate to low-loss, high-efficiency power conversion, smaller heat sinks, reduced cooling costs and lower EMI signatures. Continuing progress in raising high (250° C+) operating temperature and high blocking voltage promise exciting new applications such as motor drive in HEV/EV and solid-state transformers.

SiC is certainly not the only compound semiconductor material being considered for next-generation power components. Gallium arsenide (GaAs) Schottky rectifiers have been available since the 1990s but have only found limited acceptance for the most demanding applications due to their higher cost than silicon. GaAs bandgap, breakdown field and thermal conductivity are lower than silicon carbide. More recently, researchers are pursuing gallium nitride (GaN) for power transistors. GaN has similar bandgap and dielectric constant (hence comparable breakdown voltage) to SiC. It has higher electron mobility but only ¼ the thermal conductivity. This technology is early in its development/commercialization phase relative to SiC. Currently there are many more SiC devices and suppliers.

Figure 1 shows the reduction in switching losses compared to fast recovery diodes based on SiC SBD's minimal reverse recovery charge (Q_{rr}) during turn-off.

With silicon fast recovery diodes, the t_{rr} increases significantly with temperature as shown in Figure 2. In contrast, SiC SBDs maintain a constant t_{rr} regardless of temperature. This enables SiC SBD operation at higher temperature without increased switching losses. The numerous SiC SBD performance advantages can result in more compact, lighter power devices with higher efficiency.

SiC has demonstrated temperature stability over a wide operating range, as shown in Figure 3. This simplifies the parallel connection of multiple devices and prevents thermal runaway.

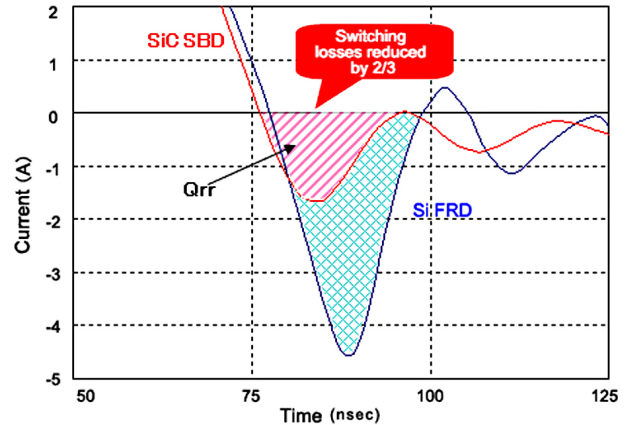

Figure 1. With an SiC Schottky barrier diode (SBD), switching losses are reduced by 2/3 compared to a silicon fast recovery diode (FRD). The Si FRD is used for comparison since it has a comparable voltage rating to the SiC SBD.

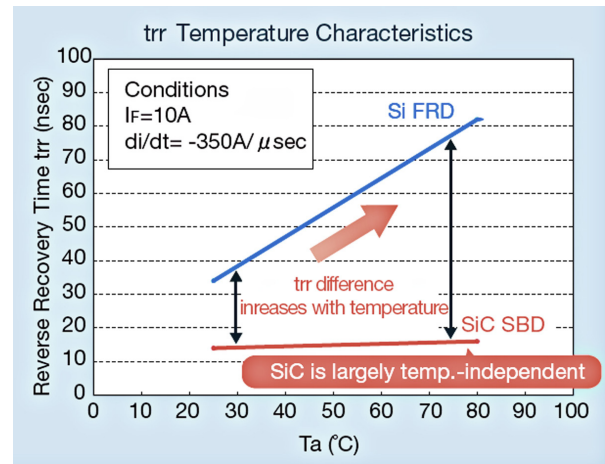

Figure 2. The reverse recovery time of a silicon FRD can easily double with a junction temperature rise of only 40°C. In contrast, silicon carbide SBDs are essentially flat over this same temperature range.

With all of these benefits, why hasn't SiC had more of an impact in new products? One reason is the continuous improvements of silicon devices, which benefits from having an infrastructure – process, circuit design, production equipment – that has been fine tuned for over fifty years. By contrast, SiC technology is still in its infancy. The higher cost of SiC devices has been a barrier to most commercial applications. This is due in large part to the fact that SiC is a much more difficult material to process than silicon. For example, costly ion implantation is used for doping because of SiC's low diffusion rate. Reactive ion etching (RIE) with a fluorine-based plasma is performed, followed by annealing at

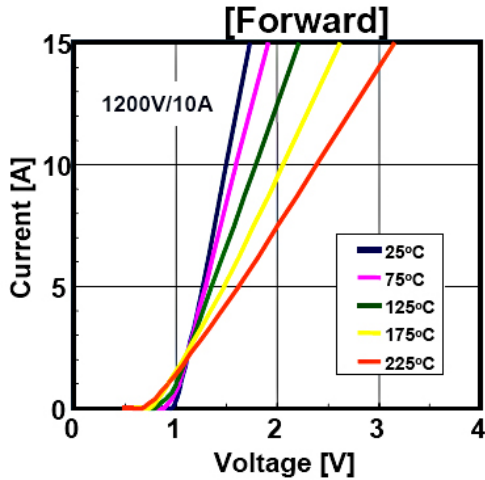

Figure 3. The forward voltage of a high voltage (1200V) silicon carbide SBD increases less than 2X when the temperature increases from 25°C to 225°C.

high temperature. These processing difficulties increase cost and limit the types of device structures that can be built. As a result, the cost is high and availability limited. However, this is about to change.

The Timing is Right for Silicon Carbide Technology

Though the first commercial SiC SBDs were available in 2001, adoption has been limited until recently. The increase in interest and adoption in many applications are predominantly due to:

- lower production costs;
- availability of SiC transistors;
- wider pool of suppliers;
- the rise of green energy in general, and power conversion efficiency in particular, driven by legislation and market demands; and
- new applications such electric vehicles (EVs) and charging stations.

Cost

In its report “SiC 2010,” Yole Developpement identified the transition to 4-inch (100-mm) SiC wafers as a significant milestone towards reduced cost. The report states, “The total SiC substrate merchant market has reached approximately \$48M in 2008. It is expected to exceed \$300M in a decade.” The coming transition to 6-inch (150-mm) wafers is expected to play a significant role in further cost reduction and market growth. According to the report, “150-mm wafers will definitely accelerate the cost reduction of SiC device manufacturing.” Figure 4 shows the growth that can be expected for SiC substrates in photovoltaic (PV) inverters, a key application requiring high efficiency.

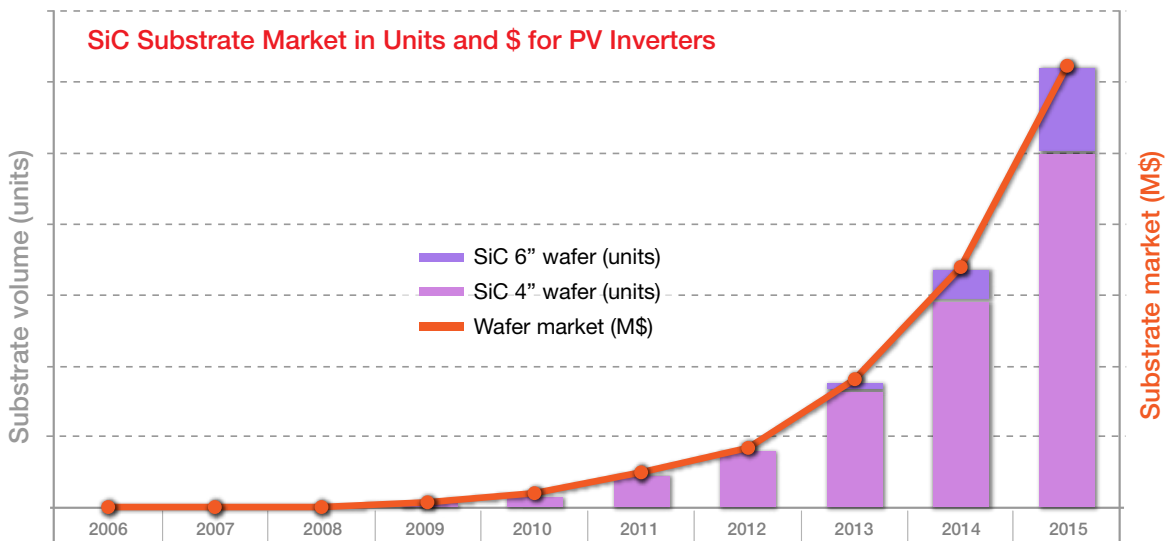

Figure 4. Increased wafer sizes of 4 and 6-inch will accelerate market acceptance of SiC. Source: Yole Developpement.

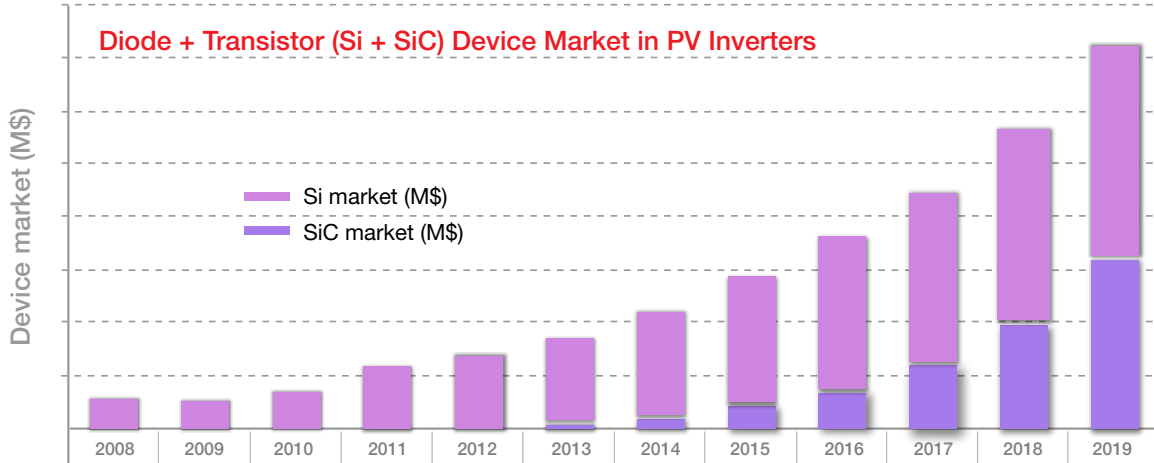

Figure 5. SiC diodes and transistors will start to grow in photovoltaic inverter applications starting in 2013. Source: Yole Developpement.

SiC Transistor

One of the main obstacles to the increased use of SiC has been the lack of an SiC transistor to provide a complete SiC solution. With the ongoing global R&D efforts in this area, Yole expects to see volume production within the next few years. Figure 5 shows the impact this will have in one market – photovoltaic converters. The growth is based on a greater number of suppliers and increased production capacity for both SiC diodes and transistors.

Legislation and Market Push for Green Energy

Governments around the globe are pursuing renewable energy sources to reduce the dependence on fossil fuels and reduce CO₂ emissions. For example, in the U.S., President Obama has set a goal of generating 80% of America’s electricity from clean sources by 2035.

California’s Renewables Portfolio Standard (RPS), established in 2002 under Senate Bill 1078, is one of the most ambitious renewable energy standards in the country. It requires that 20% of a utility’s portfolio should come from renewable energy by 2017. These and other efforts will drive the need for SiC PV inverters.

Other applications that are attracting early adopters of SiC technology and seeing early implementation include those where the need for high efficiency is either a major end-product differentiator and/or where legislation and regulations dictate a minimum energy efficiency level.

Some key regulatory milestones are:

- January 2001, IEC-61000-4-3 requirements stimulate active power factor correction (PFC) to minimize energy loss and distortion in AC/DC switch mode power supply (SMPS) designs (see Figure 6). Many power products are required to meet

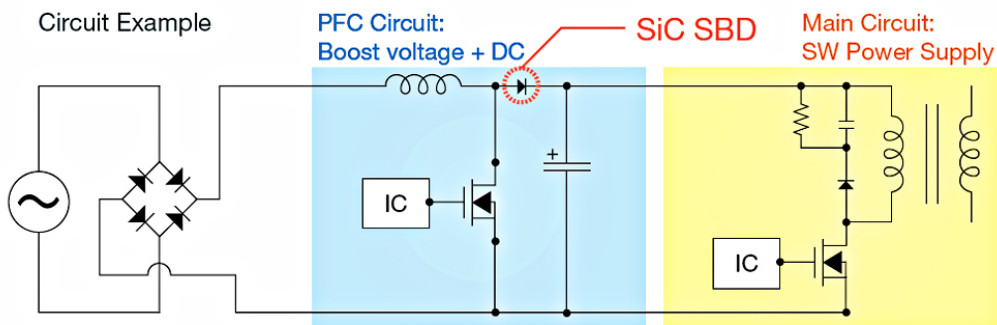

Figure 6. A simplified active PFC boost converter typically requires a power MOSFET, a blocking diode, an inductor and a capacitor. Not shown is a snubber circuit to mitigate EMI emission.

80 PLUS Test Type	115V Internal Non-Redundant			230V Internal Redundant			
	Percent of Rated Load	20%	50%	100%	20%	50%	100%
80 PLUS Basic		80%	80%	80%	Not defined		
Bronze 82%		85%	82%	81%	85%	81%	
Silver 85%		88%	85%	85%	89%	85%	
Gold 87%		90%	87%	88%	92%	88%	
Platinum 90%		92%	89%	90%	94%	91%	

Table 2. 80 PLUS Efficiency Levels. Per ENERGY STAR 5.0, desktop computer, laptop computer or server power supplies must comply with the Bronze level. Source: Wikipedia.

both minimum power factor and efficiency levels.

- In 2004, the 80 Plus program was launched that requires 80% or higher energy efficiency at various loads (see Table 2). SiC SBDs allow power supply designers to meet high efficiency certification levels such as 80 Plus Bronze, Silver, or Gold.
- In July 2009, the U.S. Department of Energy (DOE) ENERGY STAR v5.0 specification for computers that includes 80 Plus power supply efficiency was adopted by the European Commission and the U.S. government.

SiC advantages in real-world applications

SMPs with output power ratings above 300 W typically use active PFC boost converters designed to operate in continuous conduction mode (CCM). The single biggest advantage of using SiC diode in place of Si diode is the former's much lower reverse recovery current (See Figure 1), which translates into approximately 60% lower switching loss and elimination (or great simplification) of the snubber circuit to control EMI. Also, the switching transistor no longer has to be derated to accommodate the large reverse current from the silicon blocking diode — a lower amperage, less expensive transistor can be used. With lower loss, the heat sink/cooling system can be made smaller. Lower switching loss allows the circuit to operate at higher frequency giving designers options to further increase efficiency and/or to reduce the choke's size, saving cost and board space.

As a practical example, consider the PFC circuit in a 1 KW AC-DC power supply with the following characteristics:

- Input: 100 Vac, 60 Hz
- Output: 400 Vdc, 2.5 A
- Switching frequency: 50 KHz
- Operating temperature: 100° C

Table 3 summarizes the performance comparison between a circuit using a 600V Si FRD and an SiC SBD.

	Si-FRD	ROHM SiC SBD
Peak reverse current	56 A	14 A
Power conversion efficiency	93.13%	95.57%
Harmonic distortion	2.42%	2.36%

Table 3. Performance comparison between circuits using 600 V / 20 A Si-FRD and ROHM 600 V / 10A SBD (SCS110AG).

Improvements similar to those in power supplies and PFC circuits can be obtained in other applications. For example, inverters with SiC SBDs have dramatically reduced recovery losses, resulting in improved efficiency. When used with IGBTs and lower operating frequencies, the lower thermal losses allow for smaller heat sinks.

Using ROHM's SiC SBDs, customers report improvements of system-level efficiency from 0.3% to 1.0%. This translates into an annual savings of over \$50 for a 20 kW inverter operating at a cost of \$0.10/kW-hr. For products with a long lifetime such as solar inverters, this provides a savings of \$750 in 15 years or \$1500 in 30 years.

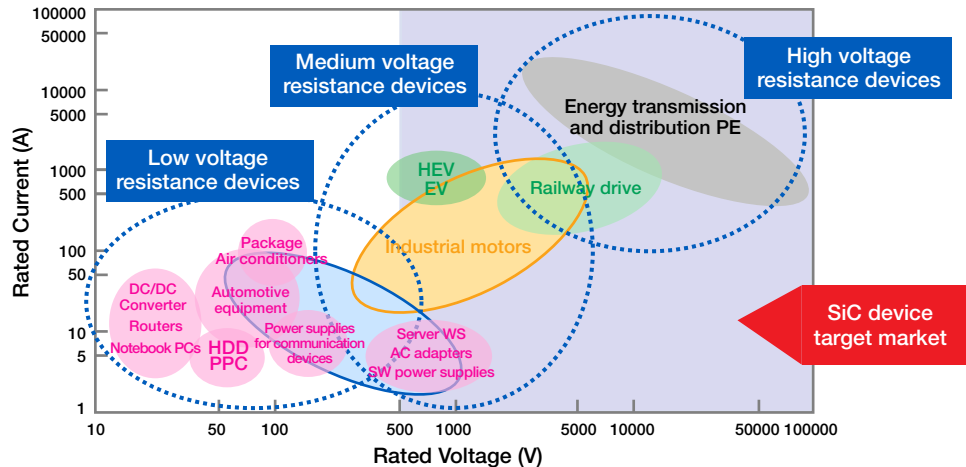

Figure 7. Target applications for silicon carbide's higher efficiency vary depending on voltage and current rating.

In addition to photovoltaic inverters and PFC, other applications for 600 V and lower SiC devices include switching circuits, uninterruptible power supplies (UPS), motor drive circuits, and others where high efficiency is a product differentiator. Figure 7 shows how various application areas are distributed according to blocking voltage and current handling requirements. Though today's SiC devices still trail IGBT in power rating and the types of devices are still limited, in general the higher these requirements are, the more compelling the adoption of SiC technology.

Challenges to SiC adoption

The main obstacles to widespread adoption of SiC are cost, availability (of different device types as well as a larger supplier pool) and familiarity of the engineering community with this technology.

For SiC components to be widely adopted in power electronics, the premium over Si must come down. SiC diodes are approximately 5x more expensive than Si FRDs. As with silicon, lower costs will be realized by improving yield as the technology matures, the use of larger wafers, and an increase in the number of suppliers. In the past few years, more vendors — both small and large, startups and established - have joined the "race." As a result, a variety of SiC devices are or will soon be available, including various flavors of diodes and

transistors (MOSFETs, JFETs, BJTs), SiC diodes packaged with Si transistors, SiC module, etc.

A rapidly emerging field that can dramatically accelerate the need for SiC are vehicles with some form of electric propulsion such as hybrid, plug-in hybrid, electric, and fuel cell vehicles. Efficiency, size, and cost are extremely important factors, making SiC devices particularly suitable. These vehicles require the efficiency that SiC can provide and, equally important, they have an operating environment that demands SiC's temperature stability and higher temperature operating capabilities. Cars with SiC SBDs and SiC transistors can potentially eliminate a liquid cooling system to help justify the increased costs of SiC technology. Acceptance in these vehicles will create a high volume demand and push the technology into the mainstream.

While EV usage will occur in the future when SiC transistors are more affordable and widely available, having them as a driving force should encourage engineers with other applications to take a closer look at SiC technology.

As described earlier in the PFC application example, SiC can in many cases serve as a drop-in replacement for its Si counterpart. This example also makes it clear that, to fully realize the performance benefits and potential cost savings, (e.g., no or simplified snubber, using switching

transistor with lower current rating), designers must be fully aware of the characteristics of SiC devices. Those who take advantage of SiC's capabilities early, when only diodes are widely available, will be in a much better position to judge, adopt, and fully realize the benefits of future SiC components (transistors, modules, etc.) in power applications.

ROHM Semiconductor's Silicon Carbide Solutions

As a leading designer and manufacturer of semiconductor products, from VLSI integrated circuits to discretes and passives to optical electronics, ROHM recognized the potential of and made significant investment in silicon carbide technology many years ago. Some of the major milestones in its history of silicon carbide research and development have been announced and are worth noting.

ROHM's pioneering efforts resulted in the successful development of a silicon carbide double-diffusion metal-oxide-semiconductor field-effect transistor (DMOSFET) prototype in 2004. Schottky barrier diodes and power modules that incorporated SiC transistors and SBDs were developed soon afterward. Improvements and enhancements were made to the SiC SBDs based on customer feedback in 2005. This led to the development of a uniform production system for SiC devices.

Mass production of SiC transistors has proven particularly challenging to manufacturers worldwide. Therefore, in parallel, ROHM partnered with university and industrial partners to develop production processes and equipment. ROHM overcame several significant obstacles and successfully established the industry's first mass production system for SiC transistors. To do this, ROHM developed a proprietary field-weakening architecture and unique screening methods to ensure reliability and technology that limits the degradation in characteristics caused by the high-temperature (up to 1,700° C) processes required in SiC fabrication.

ROHM has also solved the problems associated with mass production of SiC SBD devices, such as uniformity of the Schottky contact barrier and formation of a high-resistance guard ring layer that does not require high temperature processing, making uniform, in-house production possible.

In 2008, ROHM together with Nissan Motor Co., Ltd. announced the development of a heterojunction diode (HJD). The HJD delivers avalanche energy and fracture resistance that exceed the performance of previous designs by a factor of 10. ROHM had been shipping HJD engineering samples along with proprietary high-power SBDs and MOSFETs for two years prior to the announcement. During that time, engineers worked aggressively to improve the underlying technologies for commercialization.

In 2010, ROHM acquired SiCrystal AG, a leading producer and supplier of high-quality, single-crystalline silicon carbide wafers. SiCrystal's capabilities include complete materials processing from crystal growth to wafering. With the acquisition of SiCrystal AG, ROHM possesses total manufacturing capability for SiC semiconductors from ingot formation to power device fabrication. This allows the rapid development of advanced products and complete control of raw materials for industry-leading reliability and quality.

ROHM's R&D activities also include the development of the industry's first SiC Trench MOSFET as well as high power modules using SiC Trench MOSFETs and SBDs compatible with operating temperatures greater than 200° C.

ROHM's SiC offerings include Schottky barrier diodes, MOSFETs, and modules. 600 V SBDs are in mass production and are available as bare die or packaged parts. 1200 V SBDs and MOSFETs are currently sampled to customers in North America. In the pipeline are paired SiC SBD plus Si transistor in a single package as well as all-SiC modules.

Part No.	Absolute Maximum Ratings (Ta = 25°C)				Electrical Characteristics (Ta = 25°C)				Package
	V _{RM} (V)	V _R (V)	I _O (A)	IFSM(A)	V _F (V)		I _R (μA)		
				60Hz.1	Typ.	I _F (A)	Max.	V _R (V)	
SCS106AGC	600	600	6	24	1.5	6	120	600	TO-220AC [2 pin]
SCS108AGC	600	600	8	32	1.5	8	160	600	TO-220AC [2 pin]
SCS110AGC	600	600	10	40	1.5	10	200	600	TO-220AC [2 pin]
SCS112AGC	600	600	12	48	1.5	12	240	600	TO-220AC [2 pin]
SCS120AGC	600	600	20	80	1.5	20	400	600	TO-220AC [2 pin]

Table 4. Available Schottky barrier diodes range from 6A to 20A-rated 600V products.

ROHM Semiconductor Silicon Carbide Schottky Barrier Diodes

Though SiC components still command a sizeable (est. 5x currently) premium in price over Si, the technology has advanced to the point where the benefits are compelling for an increasing number of applications. This is especially the case for Schottky barrier diodes. Currently the largest markets for SiC SBDs are PFC / power supplies and solar inverters.

ROHM Semiconductor's SCS1xxAGC series of SiC Schottky barrier diodes has a rated blocking voltage of 600V, is available in 6, 8, 10, 12 and 20 A, and offers industry-leading low forward voltage and fast recovery time. Compared to Si FRD diodes, all SiC diodes incur much lower switching loss. Compared to other SiC diodes, ROHM SiC SBDs feature lower V_F and thus comparatively lower conduction loss. Table 3 shows the characteristics at room temperature, but the low V_F advantage remains true at high (150°C) as well.

It's worth noting that the 20 A-rated part is achieved with a single die, not by paralleling two die (although the 2-die version is available for sampling for interested customers).

Table 4 presents a more detailed description of ROHM 600 V SBDs. All products have a typical t_{rr} of 15 nsec.

At higher temperatures, ROHM Semiconductor SBDs demonstrate a smaller increase in V_F than other available products. For example at 150° C, the 10 A/600 V SCS110AGC features a V_F of 1.6 V (1.5 V @25° C) compared to 1.6 V (1.4 V@25°C), 1.85 V and 2.2 V for comparably rated SBDs from other suppliers.

Initial SBDs are rated at a maximum operating temperature of 150°C. Even though SiC has the capability to perform at much higher temperatures than silicon devices, most engineers will initially design to the 150°C maximum rating they have traditionally used and use the higher operating capability as a safety factor.

Initial products are offered in the popular TO-220, 2-pin package with exposed fin. ROHM Semiconductor also utilizes surface mount D2PAK and TO-220 fully isolated packaging technology. These packages may be offered in the future depending on customer interest.

These Schottky barrier diodes are but the first in ROHM's SiC product lineup. And through extensive R&D activities, more products in the pipeline. In fact, 1200 V SiC SBDs and MOSFETs are already sampling at strategic partners to address higher power applications such as UPS and to develop all-SiC power devices. SiC and Si combination and all-SiC modules are also expected to be part of future offerings.

Silicon Carbide for Today's Designs

ROHM Semiconductor process and device technologies incorporate advancements that address performance and cost aspects of SiC SBDs. The 600 V Schottky barrier diodes in production today provide both low V_F for reduced conduction loss with ultra-short reverse recovery time to enable efficient high-speed switching.

With its long history and investment in SiC development, including the recent the acquisition of SiCrystal, ROHM Semiconductor is well-positioned to provide leading-edge SiC products in production quantities. Unlike many startups that are taking compound semiconductor research into pilot manufacturing lines, ROHM Semiconductor already possesses high volume

manufacturing capability. Furthermore, it has complete control over the entire SiC manufacturing and designing process. ROHM is currently the only supplier capable of offering a complete range of SiC products, from bare die to package parts to modules.

ROHM considers products that enable increased energy efficiency – SiC products in particular – as a key growth driver. ROHM is committed to continue driving SiC technology development and offering a full range of competitive SiC products.

Expect more device types, higher-performance and cost-competitive SiC products from ROHM Semiconductor in the near future.



ROHM Semiconductor
6815 Flanders Drive, Suite 150
San Diego, CA 92121

www.rohm.com/us | 1.888.775.ROHM



NOTE: For the most current product information, contact a ROHM sales representative in your area.

ROHM assumes no responsibility for the use of any circuits described herein, conveys no license under any patent or other right, and makes no representations that the circuits are free from patent infringement. Specifications subject to change without notice for the purpose of improvement.

The products listed in this catalog are designed to be used with ordinary electronic equipment or devices (such as audio visual equipment, office-automation equipment, communications devices, electrical appliances and electronic toys). Should you intend to use these products with equipment or devices which require an extremely high level of reliability and the malfunction of which would directly endanger human life (such as medical instruments, transportation equipment, aerospace machinery, nuclear-reactor controllers, fuel controllers and other safety devices), please be sure to consult with our sales representative in advance.

© 2011 ROHM Semiconductor USA, LLC. Although every effort has been made to ensure accuracy, ROHM accepts no responsibility for errors or omissions. Specifications and product availability may be revised without notice. No part of this document represents an offer or contract. Industry part numbers, where specified, are given as an approximate comparative guide to circuit function only. Consult ROHM prior to use of components in safety, health or life-critical systems. All trademarks acknowledged.

Looking for pricing, stock, or lifecycle information?

Click below to explore more details on WIN SOURCE:

- ⊖ [View SCS106AGC on WIN SOURCE](#)
- ⊖ [Rohm Semiconductor Information](#)

Optimize Your Supply Chain with WIN SOURCE Solutions

- ✓ Global Sourcing Solution
- ✓ Obsolete Management
- ✓ Cost Control Management
- ✓ Shortage Management
- ✓ Alternative Solution
- ✓ Excess Inventory Management