



**THE DATASHEET OF
BAW78DE6327HTSA1**



Silicon Switching Diodes

- Switching applications
- High breakdown voltage
- Pb-free (RoHS compliant) package ¹⁾
- Qualified according AEC Q101

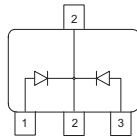
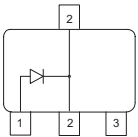
BAW78D
BAW79D

Type	Package	Configuration	Marking
BAW78D	SOT89	single	GD
BAW79D	SOT89	common cathode	GH

Maximum Ratings at $T_A = 25^\circ\text{C}$, unless otherwise specified

Parameter	Symbol	Value	Unit
Diode reverse voltage	V_R	400	V
Peak reverse voltage	V_{RM}	400	
Forward current	I_F	1	A
Peak forward current	I_{FM}	1	
Peak forward current	I_{FM}	1	
Surge forward current, $t = 1 \mu\text{s}$	I_{FS}	10	
Non-repetitive peak surge forward current	I_{FSM}	-	
Total power dissipation	P_{tot}		W
BAW78D, $T_S \leq 125^\circ\text{C}$		1	
BAW79D, $T_S \leq 115^\circ\text{C}$		1	
Junction temperature	T_j	150	$^\circ\text{C}$
Storage temperature	T_{stg}	-65 ... 150	

¹⁾Pb-containing package may be available upon special request

Thermal Resistance

Parameter	Symbol	Value	Unit
Junction - soldering point ¹⁾	R_{thJS}		K/W
BAW78D		≤ 25	
BAW79D		≤ 35	

Electrical Characteristics at $T_A = 25^\circ\text{C}$, unless otherwise specified

Parameter	Symbol	Values			Unit
		min.	typ.	max.	

DC Characteristics

Breakdown voltage $I_{(BR)} = 100 \mu\text{A}$	$V_{(BR)}$	400	-	-	V
Reverse current $V_R = 400 \text{ V}$ $V_R = 400 \text{ V}, T_A = 150 \text{ }^\circ\text{C}$	I_R	-	-	1 50	μA
Forward voltage $I_F = 1 \text{ A}$ $I_F = 2 \text{ A}$	V_F	-	-	1.6 2	V

AC Characteristics

Diode capacitance $V_R = 0 \text{ V}, f = 1 \text{ MHz}$	C_T	-	10	-	pF
Reverse recovery time $I_F = 200\text{mA}, I_R = 200\text{mA}$, measured at $I_R = 20\text{mA}$ $R_L = 100\Omega$	t_{rr}	-	1	-	μs

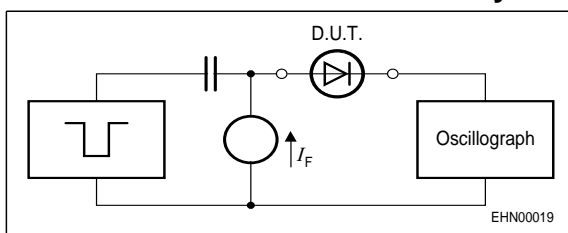
Test circuit for reverse recovery time

Puls generator: $t_p = 10\mu\text{s}$, $D = 0.05$,
 $t_r = 0.6\text{ns}$, $R_i = 50\Omega$

Oscilloscop: $R = 50\Omega$, $t_r = 0.35\text{ns}$
 $C \leq 1\text{pF}$

¹⁾For calculation of R_{thJA} please refer to Application Note Thermal Resistance

Reverse current $I_R = f(T_A)$

$V_R = 400V$

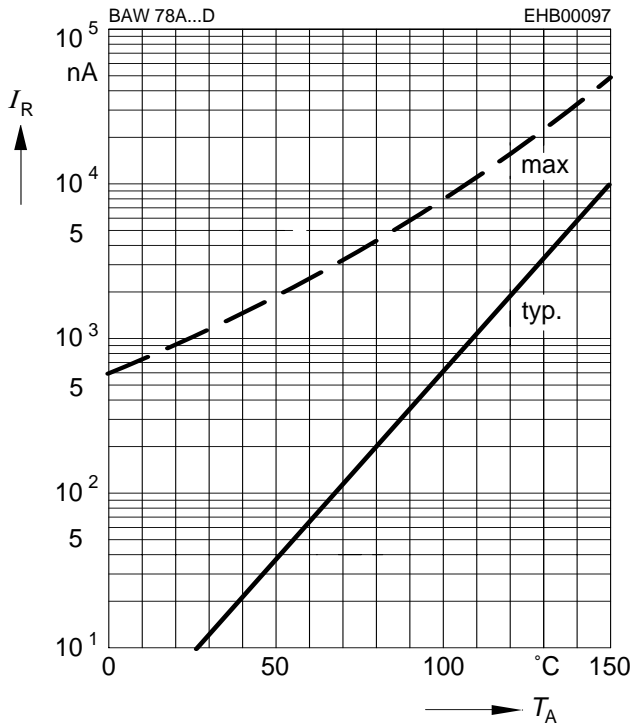

Forward current $I_F = f(V_F)$

$T_A = 25^\circ C$

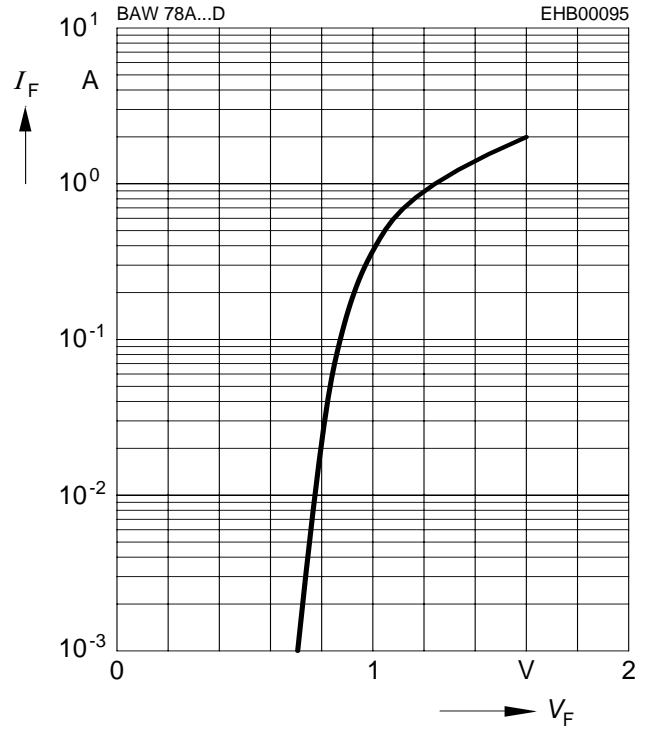

Peak forward current $I_{FM} = f(t_p)$

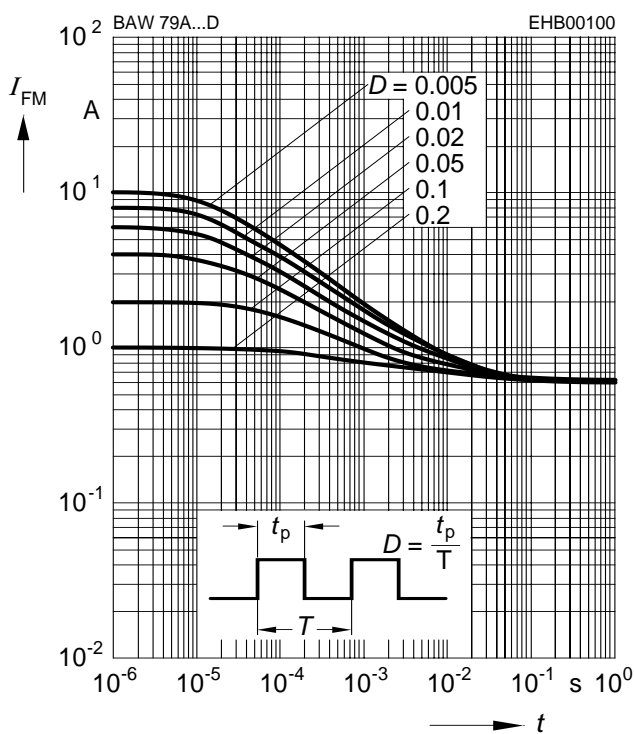

Forward current $I_F = f(T_S)$

BAW78D

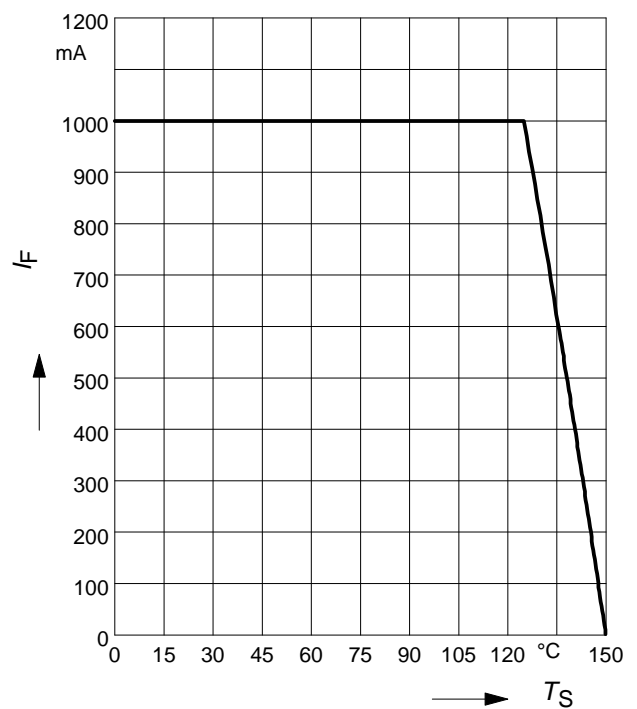

Forward current $I_F = f(T_S)$

BAW79D

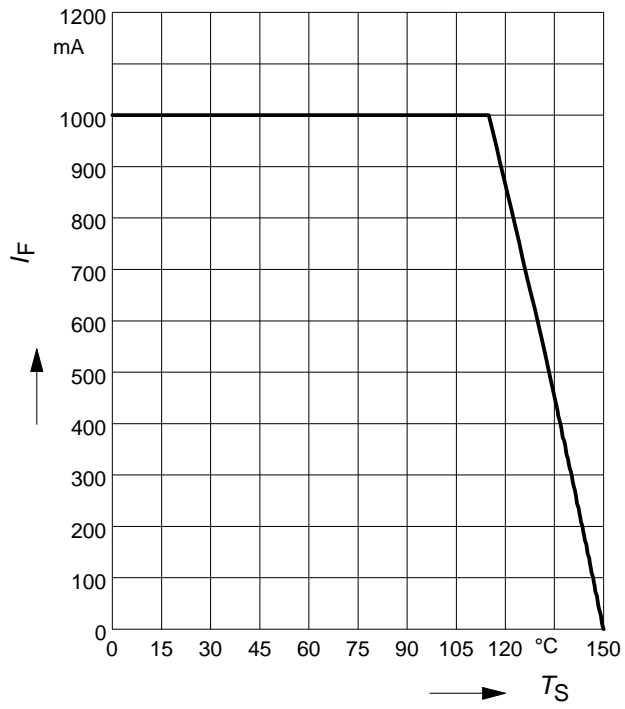

Package Outline

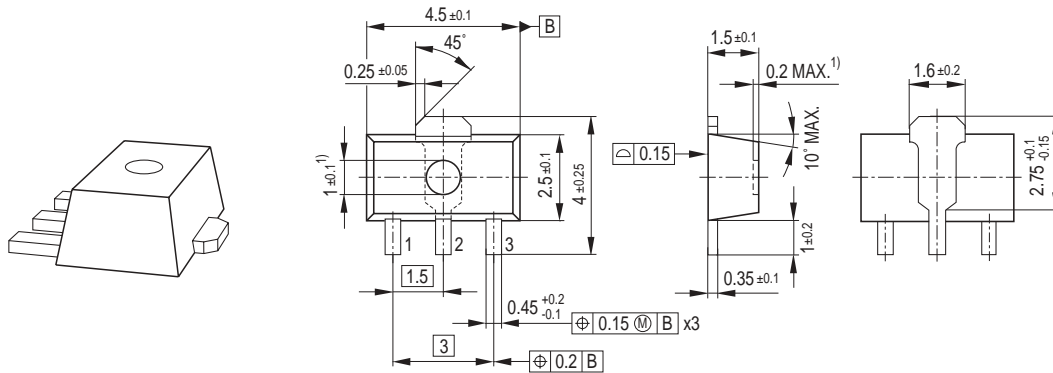

1) Ejector pin markings possible

Foot Print

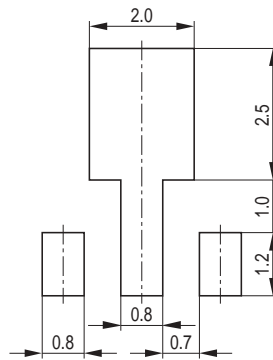

Marking Layout (Example)

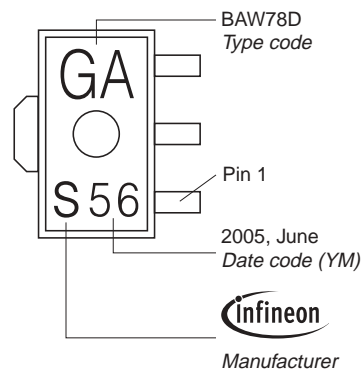

Standard Packing

Reel $\varnothing 180 \text{ mm} = 1.000 \text{ Pieces/Reel}$
 Reel $\varnothing 330 \text{ mm} = 4.000 \text{ Pieces/Reel}$

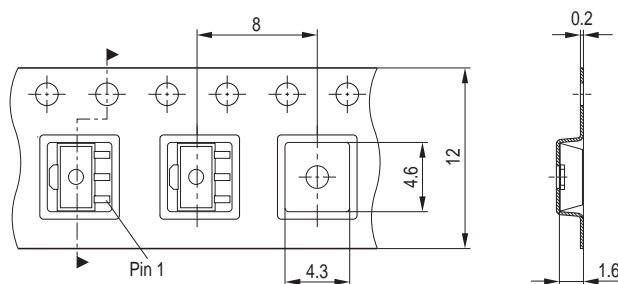

Edition 2006-02-01

Published by

Infineon Technologies AG

81726 München, Germany

© Infineon Technologies AG 2007.

All Rights Reserved.

Attention please!

The information given in this dokument shall in no event be regarded as a guarantee of conditions or characteristics ("Beschaffenheitsgarantie"). With respect to any examples or hints given herein, any typical values stated herein and/or any information regarding the application of the device, Infineon Technologies hereby disclaims any and all warranties and liabilities of any kind, including without limitation warranties of non-infringement of intellectual property rights of any third party.

Information

For further information on technology, delivery terms and conditions and prices please contact your nearest Infineon Technologies Office (www.infineon.com).

Warnings



Due to technical requirements components may contain dangerous substances. For information on the types in question please contact your nearest Infineon Technologies Office.

Infineon Technologies Components may only be used in life-support devices or systems with the express written approval of Infineon Technologies, if a failure of such components can reasonably be expected to cause the failure of that life-support device or system, or to affect the safety or effectiveness of that device or system.

Life support devices or systems are intended to be implanted in the human body, or to support and/or maintain and sustain and/or protect human life. If they fail, it is reasonable to assume that the health of the user or other persons may be endangered.

Looking for pricing, stock, or lifecycle information?

Click below to explore more details on WIN SOURCE:

-  [View BAW78DE6327HTSA1 on WIN SOURCE](#)
-  [Infineon Technologies Information](#)

Optimize Your Supply Chain with WIN SOURCE Solutions

-  Global Sourcing Solution
-  Obsolete Management
-  Cost Control Management
-  Shortage Management
-  Alternative Solution
-  Excess Inventory Management