

ALSO
AVAILABLE IN
SURFACE
MOUNT

DESCRIPTION

The 3EZ3.9D5 thru 3EZ200D5 series of axial-leaded 3.0 watt Zeners provides voltage regulation selections with 5% tolerances from 3.9 to 200 volts in a DO-41 plastic package size. Other Zener voltage tolerances are also available by changing the suffix number to the tolerance desired such as 1, 2 3, or 4 for tighter tolerances or 10 for wider tolerance. These plastic encapsulated Zeners are also available in various military equivalent screening levels by adding a prefix identifier as also described in the Features section. They may be operated at high maximum dc currents or full power rating with adequate heat. Microsemi also offers numerous other Zener products to meet higher and lower power applications.

APPEARANCE

**DO-41 or
DO-204AL
(Plastic)**

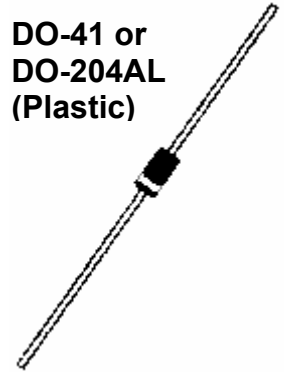

IMPORTANT: For the most current data, consult MICROSEMI's website: <http://www.microsemi.com>

FEATURES

- Zener voltage available 3.9 V to 200 V
- Standard voltage tolerances are plus/minus 5% with a 5 suffix and 10 % with 10 suffix identification
- Tight tolerances available in plus or minus 4%, 3%, 2% or 1% with 4, 3, 2, or 1 suffix respectively
- Options for screening in accordance with MIL-PRF-19500 for JAN, JANTX, JANTXV, and JANS are available by adding MQ, MX, MV, or MSP prefixes respectively to part numbers.
- Surface mount equivalents available as SMBJ3EZ3.9D5 to SMBJ3EZ200D5 in the DO-214AA package, or SMBG3EZ3.9D5 to SMBG3EZ200D5 in the DO-215AA package
- RoHS compliant devices available by adding "e3" suffix

APPLICATIONS / BENEFITS

- Regulates voltage over a broad operating current and temperature range
- 3 W capability in relatively small DO-41 package size when adequately heat sunk (see Figure 1)
- Wide selection from 3.9 to 200 V
- Flexible axial-lead mounting terminals
- Nonsensitive to ESD per MIL-STD-750 Method 1020
- Withstands surge stresses
- High specified maximum current (I_{ZM}) when adequately heat sunk

MAXIMUM RATINGS

- Power dissipation at 25°C: 3.0 watts (also see derating in Figure 1).
- Operating and Storage temperature: -65°C to +150°C
- Thermal Resistance: 40 °C/W junction to lead at 3/8 (10 mm) lead length from body, or 100°C/W junction to ambient when mounted on FR4 PC board (1oz Cu) with 4 mm² copper pads and track width 1 mm, length 25 mm
- Steady-State Power: 3 watts at $T_L \leq 30^\circ\text{C}$ 3/8 inch (10 mm) from body, or 1.25 watts at $T_A = 25^\circ\text{C}$ when mounted on FR4 PC described for thermal resistance (also see Figure 1)
- Forward voltage @200 mA: 1.2 volts (maximum)
- Solder Temperatures: 260 °C for 10 s (max)

MECHANICAL AND PACKAGING

- CASE: Void-free transfer molded thermosetting epoxy body meeting UL94V-0
- TERMINALS: Leads, tin-lead or RoHS compliant annealed matte-Tin plating solderable per MIL-STD-750, method 2026
- POLARITY: Cathode indicated by band where diode is to be operated with the banded end positive with respect to the opposite end for Zener regulation
- MARKING: Part number
- TAPE & REEL option: Standard per EIA-296 (add "TR" suffix to part number)
- WEIGHT: 0.4 grams
- See package dimensions on last page

ELECTRICAL CHARACTERISTICS @ 25°C

MICRO TYPE NUMBER (Note 1)	NOMINAL ZENER VOLTAGE (Note 2)		MAXIMUM ZENER IMPEDANCE (Note 3)			MAXIMUM REVERSE CURRENT		MAXIMUM ZENER CURRENT	MAXIMUM SURGE CURRENT (Note 4)
	$V_z @ I_{zT}$		$Z_{zT} @ I_{zT}$	$Z_{zK} @ I_{zK}$		$I_R @ V_R$			
	VOLTS	mA	OHMS	OHMS	mA	μA	VOLTS	mA	A
3EZ3.9D5	3.9	192	4.5	400	1.0	80	1.0	630	4.4
3EZ4.3D5	4.3	174	4.5	400	1.0	30	1.0	590	4.1
3EZ4.7D5	4.7	160	4.0	500	1.0	20	1.0	550	3.8
3EZ5.1D5	5.1	147	3.5	550	1.0	5.0	1.0	520	3.5
3EZ5.6D5	5.6	134	2.5	600	1.0	5.0	2.0	480	3.3
3EZ6.2D5	6.2	121	1.5	700	1.0	5.0	3.0	435	3.1
3EZ6.8D5	6.8	110	2.0	700	1.0	5.0	4.0	393	2.9
3EZ7.5D5	7.5	100	2.0	700	0.5	5.0	5.0	360	2.66
3EZ8.2D5	8.2	91	2.3	700	0.5	5.0	6.0	330	2.44
3EZ9.1D5	9.1	82	2.5	700	0.5	3.0	7.0	297	2.2
3EZ10D5	10	75	3.5	700	0.25	3.0	7.6	270	2.0
3EZ11D5	11	68	4.0	700	0.25	1.0	8.4	225	1.82
3EZ12D5	12	63	4.5	700	0.25	1.0	9.1	246	1.66
3EZ13D5	13	58	4.5	700	0.25	0.5	9.9	208	1.54
3EZ14D5	14	53	5.0	700	0.25	0.5	10.6	193	1.43
3EZ15D5	15	50	5.5	700	0.25	0.5	11.4	180	1.33
3EZ16D5	16	47	5.5	700	0.25	0.5	12.2	169	1.25
3EZ17D5	17	44	6.0	750	0.25	0.5	13	150	1.18
3EZ18D5	18	42	6.0	750	0.25	0.5	13.7	159	1.11
3EZ19D5	19	40	7.0	750	0.25	0.5	14.4	142	1.05
3EZ20D5	20	37	7.0	750	0.25	0.5	15.2	135	1.0
3EZ22D5	22	34	8.0	750	0.25	0.5	16.7	123	0.91
3EZ24D5	24	31	9.0	750	0.25	0.5	18.2	112	0.83
3EZ27D5	27	28	10	750	0.25	0.5	20.6	100	0.74
3EZ28D5	28	27	12	750	0.25	0.5	21	96	0.71
3EZ30D5	30	25	16	1000	0.25	0.5	22.5	90	0.67
3EZ33D5	33	23	20	1000	0.25	0.5	25.1	82	0.61
3EZ36D5	36	21	22	1000	0.25	0.5	27.4	75	0.56
3EZ39D5	39	19	28	1000	0.25	0.5	29.7	69	0.51
3EZ43D5	43	17	33	1500	0.25	0.5	32.7	63	0.45
3EZ47D5	47	16	38	1500	0.25	0.5	35.6	57	0.42
3EZ51D5	51	15	45	1500	0.25	0.5	38.8	53	0.39
3EZ56D5	56	13	50	2000	0.25	0.5	42.6	48	0.36
3EZ62D5	62	12	55	2000	0.25	0.5	47.1	44	0.32
3EZ68D5	68	11	70	2000	0.25	0.5	51.7	40	0.29
3EZ75D5	75	10	85	2000	0.25	0.5	56	36	0.27
3EZ82D5	82	9.1	95	3000	0.25	0.5	62.2	33	0.24
3EZ91D5	91	8.2	115	3000	0.25	0.5	69.2	30	0.22
3EZ100D5	100	7.5	160	3000	0.25	0.5	76	27	0.20
3EZ110D5	110	6.8	225	4000	0.25	0.5	83.6	25	0.18
3EZ120D5	120	6.3	300	4500	0.25	0.5	91.2	22	0.16
3EZ130D5	130	5.8	375	5000	0.25	0.5	98.8	21	0.15
3EZ140D5	140	5.3	475	5000	0.25	0.5	106.4	19	0.14
3EZ150D5	150	5.0	550	6000	0.25	0.5	114	18	0.13
3EZ160D5	160	4.7	625	6500	0.25	0.5	121.6	17	0.12
3EZ170D5	170	4.4	650	7000	0.25	0.5	130.4	16	0.12
3EZ180D5	180	4.2	700	7000	0.25	0.5	136.8	15	0.11
3EZ190D5	190	4.0	800	8000	0.25	0.5	144.8	14	0.10
3EZ200D5	200	3.7	875	8000	0.25	0.5	152	13	0.10

- NOTES:**
- Suffix 1 indicates +/-1% tolerance, suffix 2 indicates +/-2% tolerance, suffix 3 indicates +/-3% tolerance, suffix 4 indicates +/-4% tolerance, suffix 5 indicates +/-5% tolerance. Suffix 10 indicates +/-10%, no suffix indicates +/-20%.
 - The V_z is measured by applying I_z 40 ms +/-10 ms prior to reading. Mounting contacts are located 3/8" to 1/2" from inside edge of mounting clips. Ambient temperature, $T_A = 25^\circ C (+8^\circ C/-2^\circ C)$.
 - The zener impedance is derived from the 60 cycle ac voltage resulting from an ac current having an rms value equal to 10% of the dc zener current (I_{zT} or I_{zK}) is superimposed on I_{zT} or I_{zK} .
 - Maximum Surge Current is a non-recurrent maximum peak reverse surge with a pulse width of 8.3 ms.

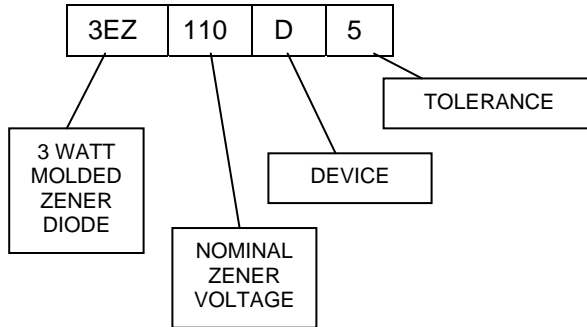

GRAPHS



FIGURE 1
POWER DERATING CURVE

PACKAGE DIMENSIONS

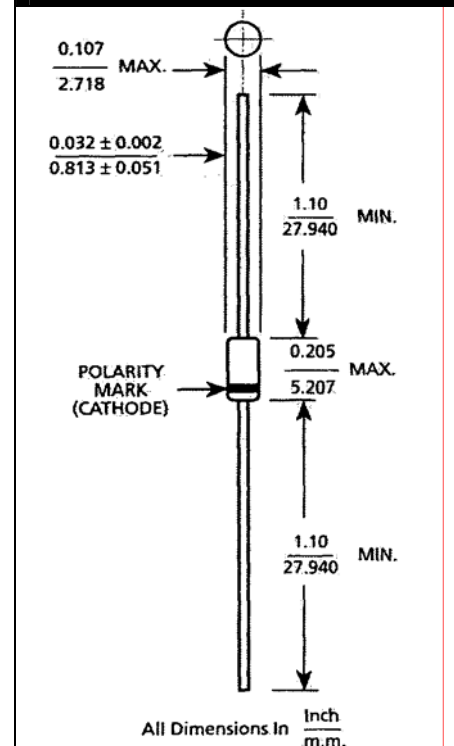

Looking for pricing, stock, or lifecycle information?

Click below to explore more details on WIN SOURCE:

 [View 3EZ150D5/TR12 on WIN SOURCE](#)

 [Microsemi Corporation](#) Information

Optimize Your Supply Chain with WIN SOURCE Solutions

-  Global Sourcing Solution
-  Obsolete Management
-  Cost Control Management
-  Shortage Management
-  Alternative Solution
-  Excess Inventory Management