

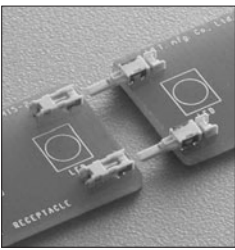

**THE DATASHEET OF
01R-LELSS-GA-TF(HF)**





LEL CONNECTOR

For LED Lamp/Board-to-board connectors

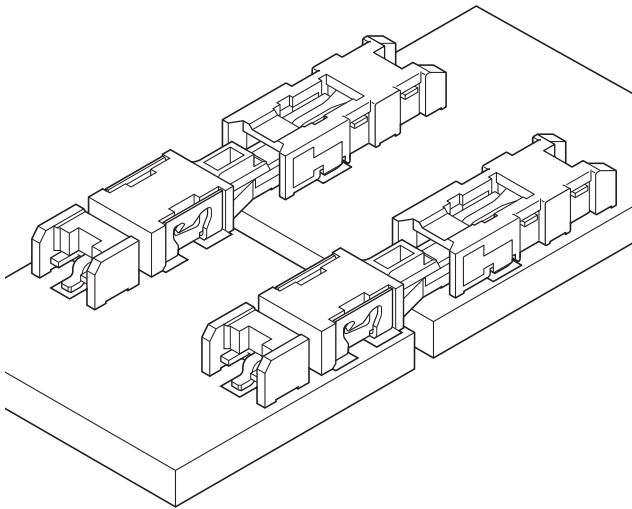

Considering about luminescence property of LED package, this LEL connector is designed as low profile type connector for LED lighting, and achieves the space saving. The horizontal connection between PCBs enables and the mechanism of absorbing the PCB misalignment has been installed considering the parallel use for the connector. Bellows type contact has a high contact pressure and a high durability performance (receptacle side) and enough mating stroke provides the stable contact performance even if the PCB expands and contracts due to heat.

- Absorption misalignment mechanism (X, Y, Z and θ directions)
- Low profile and space saving design
- Halogen-free and RoHS compliant
- The gold plating is conducted due to the long-life of LED lighting equipment.

Specifications

- Current rating: 1.6A AC, DC
- Voltage rating: 100V AC, DC
- Temperature range: -55°C to $+105^{\circ}\text{C}$
(including temperature rise in applying electrical current)
- Contact resistance: Initial value/40m Ω max.
After environmental testing/60m Ω max.
- * Compliant with RoHS.
- * Refer to "General Instruction and Notice when using Terminals and Connectors" at the end of this catalog.
- * Contact JST for details.

Plug

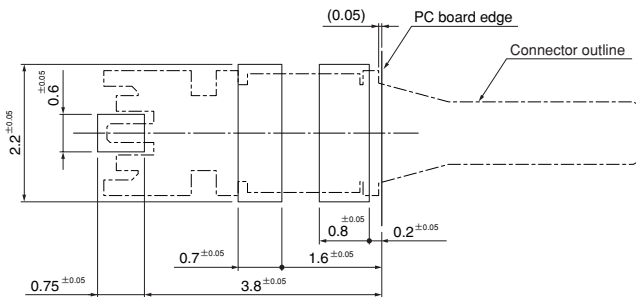

Receptacle

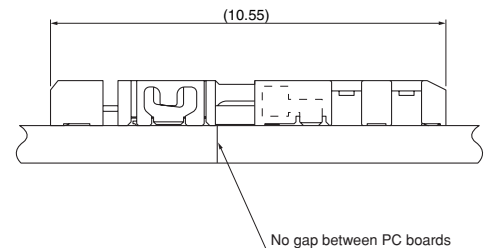
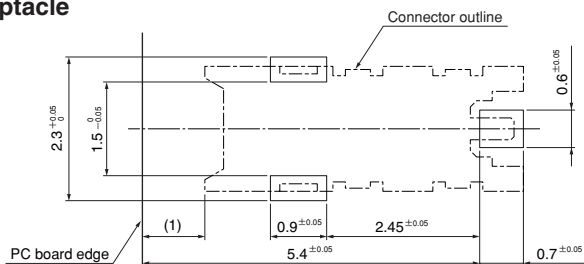

Note: 1. The above figure is the figure viewed from the connector mounting side.
2. Tolerances are non-cumulative: $\pm 0.05\text{mm}$ for all centers. The dimensions above should serve as a guideline. Contact JST for details.

LEL CONNECTOR

Plug

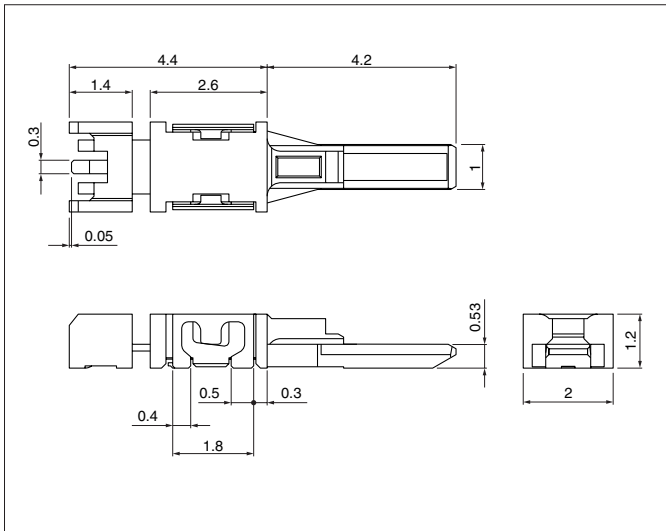

Circuits	Model No.	Q'ty / reel
1	01P-LELSS-GA-TF(HF)	15,000

Material and Finish

Contact: Copper alloy, nickel-undercoated, selective gold-plated
Housing: LCP, UL94V-0, natural
Solder tab: Copper alloy, copper-undercoated, tin-plated (reflow treatment)

RoHS compliance

Note: The products listed above are supplied on embossed-tape.

Receptacle

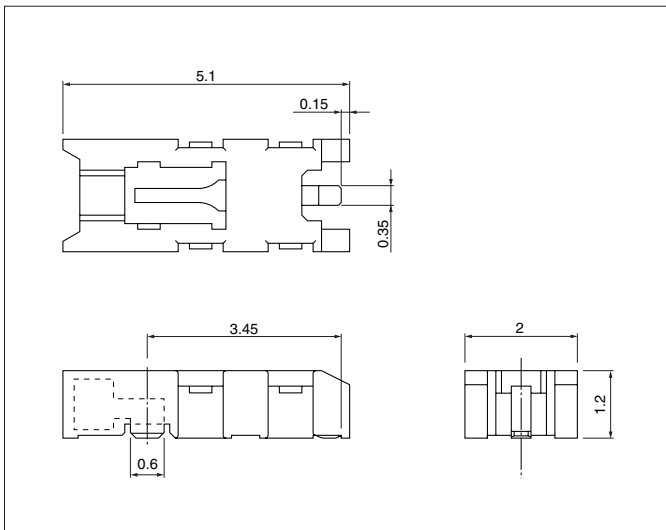

Circuits	Model No.	Q'ty / reel
1	01R-LELSS-GA-TF(HF)	15,000

Material and Finish

Contact: Copper alloy, nickel-undercoated, selective gold-plated
Housing: LCP, UL94V-0, natural
Solder tab: Copper alloy, nickel-undercoated, selective gold-plated

RoHS compliance

Note: The products listed above are supplied on embossed-tape.

Looking for pricing, stock, or lifecycle information?

Click below to explore more details on WIN SOURCE:

- [View 01R-LELSS-GA-TF\(HF\) on WIN SOURCE](#)
- [JST Sales America Inc. Information](#)

Optimize Your Supply Chain with WIN SOURCE Solutions

- ✓ Global Sourcing Solution
- ✓ Obsolete Management
- ✓ Cost Control Management
- ✓ Shortage Management
- ✓ Alternative Solution
- ✓ Excess Inventory Management