



THE DATASHEET OF HSMG-L640



Surface Mount Lensed Chip LEDs

Technical Data

HSMA-L640
HSMC-L640
HSMH-L640
HSMG-L640

Features

- **High Brightness AlInGaP Material (HSMA & HSMC)**
- **Various Colors Available**
- **Compatible with IR Solder Process**
- **Narrow Viewing Angle**
- **Small 3.0 x 1.5 mm Package**
- **Available in 8 mm Tape on 7" (180 mm) Diameter Reels**

Applications

- **Keypad Backlighting**
- **Light Piping**
- **LCD Backlighting**
- **Front Panel Indicator**

Description

The HSMx-L640 is a Chip LED with an integrated lens. The lens concentrates the emitted light into a narrow viewing angle, which has the effect of doubling the on-axis intensity. These LEDs are optimum for light piping, backlighting buttons and switches, and applications, where as much flux as possible is required on axis.

The available colors are AlInGaP Amber, AlInGaP Red, AlGaAs Red and GaP Green.

The 3.0 x 1.5 mm package closely matches industry standard sizes for chip capacitors which makes it

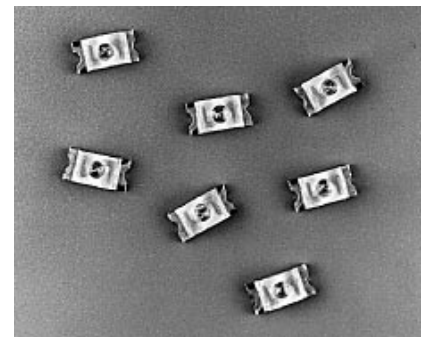

compatible with automated pick and place equipment.

This package is compatible with IR and convective reflow soldering processes.

Device Selection Guide

AS AlInGaP

Product Part Number	Color	Package Description
HSMA-L640	Amber 590 nm	Untinted, Non-diffused
HSMC-L640	Red 626 nm	Untinted, Non-diffused

GaP

Product Part Number	Color	Package Description
HSMG-L640	Green 571 nm	Untinted, Non-diffused

AlGaAs

Product Part Number	Color	Package Description
HSMH-L640	Red 639 nm	Untinted, Non-diffused

Package Dimensions

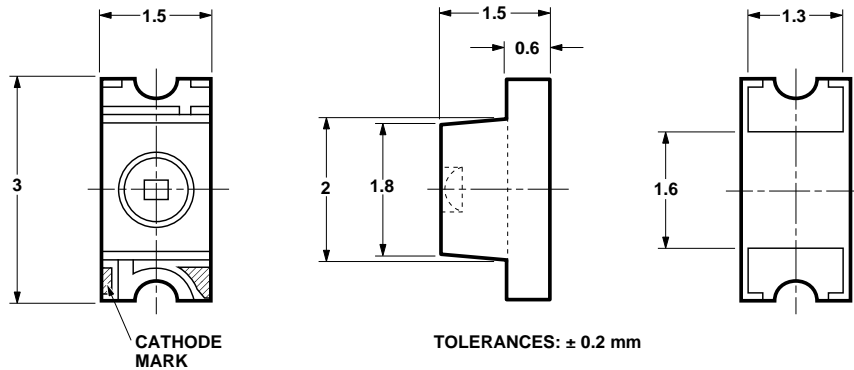

Notes:

1. Dimensions are in millimeters.
2. Tolerance, ± 0.2 mm

Absolute Maximum Ratings at $T_A = 25^\circ\text{C}$

Parameter	HSMA/C-L640	HSG/H-L640	Units
DC Forward Current ^{[3][4][5]}	30	25	mA
Power Dissipation	81	65	mW
Reverse Current $V_R = 5$ V	100	100	μA
Operating Temperature Range	-30 to +85	-30 to +85	$^\circ\text{C}$
Storage Temperature Range ^[6]	-40 to +100	-40 to +100	$^\circ\text{C}$

Notes:

3. Derate linearly as shown in Figure 4.
4. Drive currents between 1 mA and the specified maximum DC forward current are recommended for best long term performance.
5. Operating at currents below 1 mA is not recommended. Please contact your Agilent representative for further information.
6. Maximum temperature for tape and reel packaging is 60°C .

Optical Characteristics at $T_A = 25^\circ\text{C}$

Part Number	Color	Luminous Intensity I_V (mcd) @ I_F 20 mA ^[7]		Peak Wavelength λ_{peak} (nm) Typ.	Color, Dominant Wavelength λ_d ^[8] (nm) Typ.	Viewing Angle $2\theta_{1/2}$ Degrees ^[9] Typ.
		Min.	Typ.			
HSMA-L640	AS AlInGaP Amber	63	130	592	590	70
HSMC-L640	AS AlInGaP Red	63	100	635	626	70
HSMG-L640	GaP Green	10	18	570	572	70
HSMH-L640	AlGaAs Red	10	32	650	639	70

Notes:

7. The luminous intensity, I_V , is measured at the peak of the spatial radiation pattern.
8. The dominant wavelength, λ_d , is derived from the CIE Chromaticity diagram, and represents the perceived color of the device.
9. $\theta_{1/2}$ is the off-axis angle where the luminous intensity is $1/2$ the peak intensity.

Electrical Characteristics at $T_A = 25^\circ\text{C}$

Part Number	Color	Forward Voltage V_F (Volts) @ $I_F = 20\text{ mA}$		Reverse Breakdown V_R (Volts) @ $I_R = 100\ \mu\text{A}$ Min.	Capacitance C (pF) $V_F = 0$ $f = 1\text{ MHz}$ Typ.	Thermal Resistance $R\theta_{J-PIN}$ ($^\circ\text{C/W}$) Typ.
		Typ.	Max.			
HSMA-L640	AS AlInGaP Amber	2.02	2.40	5	40.0	500
HSMC-L640	AS AlInGaP Red	1.90	2.40	5	40.0	500
HSMG-L640	GaP Green	2.20	2.60	5	8.0	475
HSMH-L640	AlGaAs Red	1.80	2.20	5	4.5	475

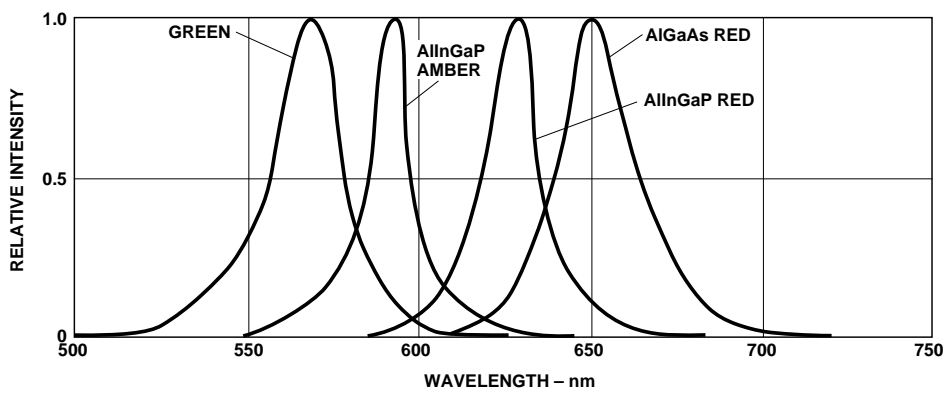

Figure 1. Relative Intensity vs. Wavelength.

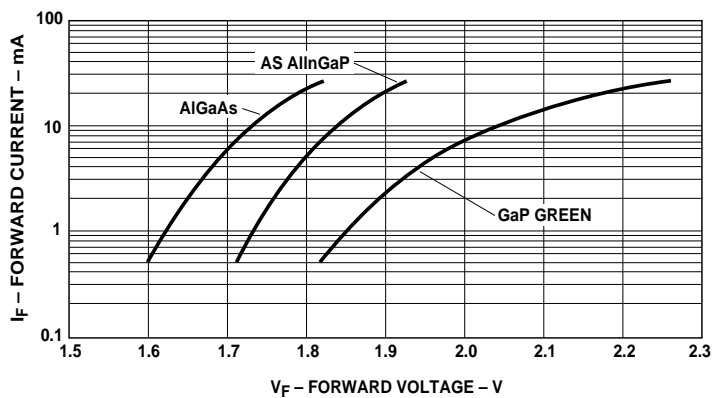

Figure 2. Forward Current vs. Forward Voltage.

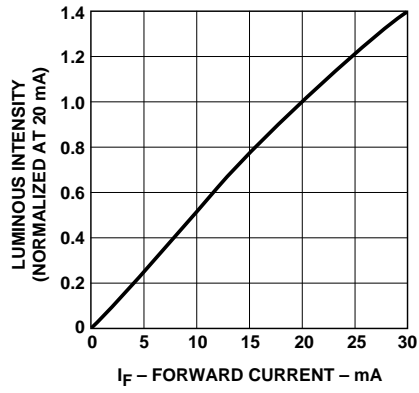

Figure 3a. Relative Luminous Intensity vs. DC Forward Current for AlInGaP.

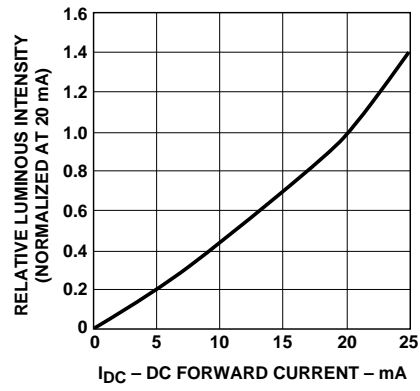

Figure 3b. Relative Luminous Intensity vs. DC Forward Current for GaP and AlGaAs.

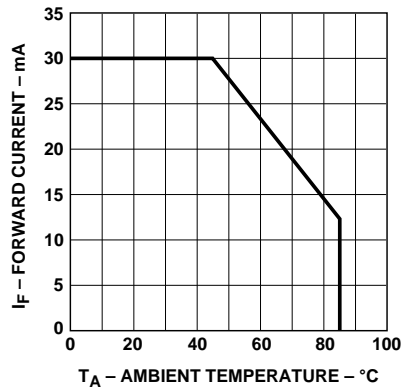

Figure 4a. Maximum DC Current vs. Ambient Temperature for AlInGaP.

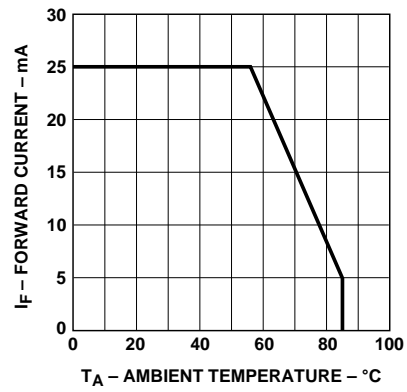

Figure 4b. Maximum DC Current vs. Ambient Temperature for AlGaAs and GaP.

Light Intensity (Iv) Bin Limits^[1]

Bin ID	Intensity (mcd)		Bin ID	Intensity (mcd)	
	Min.	Max.		Min.	Max.
A	0.11	0.18	N	28.50	45.00
B	0.18	0.29	P	45.00	71.50
C	0.29	0.45	Q	71.50	112.50
D	0.45	0.72	R	112.50	180.00
E	0.72	1.10	S	180.00	285.00
F	1.10	1.80	T	285.00	450.00
G	1.80	2.80	U	450.00	715.00
H	2.80	4.50	V	715.00	1125.00
J	4.50	7.20	W	1125.00	1800.00
K	7.20	11.20	X	1800.00	2850.00
L	11.20	18.00	Y	2850.00	4500.00
M	18.00	28.50			

Tolerance: $\pm 15\%$

Note:

- Bin categories are established for classification of products. Products may not be available in all categories. Please contact your Agilent representative for information on currently available bins.

Color Bin Limits^[1]

Amber Color Bins^[1]

Bin ID	Dom. Wavelength (nm)	
	Min.	Max.
A	582.0	584.5
B	584.5	587.0
C	587.0	589.5
D	589.5	592.0
E	592.0	594.5
F	594.5	597.0

Tolerance: ± 0.5 nm

Green Color Bins^[1]

Bin ID	Dom. Wavelength (nm)	
	Min.	Max.
A	561.5	564.5
B	564.5	567.5
C	567.5	570.5
D	570.5	573.5
E	573.5	576.5

Tolerance: ± 0.5 nm

Note:

- Bin categories are established for classification of products. Products may not be available in all bin categories. Please contact your Agilent representative for information of currently available bins.

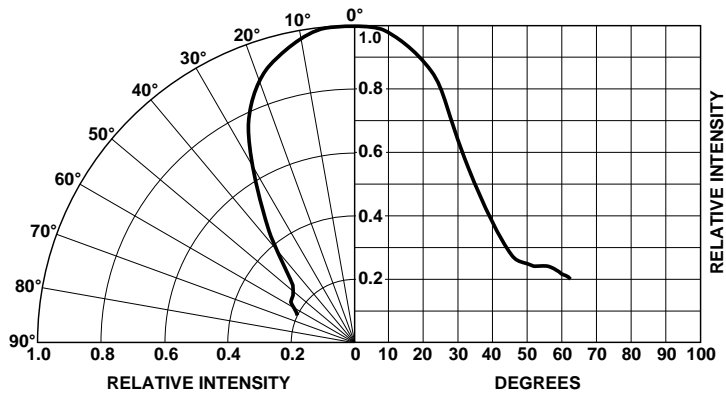

Figure 5. Intensity vs. Angle.

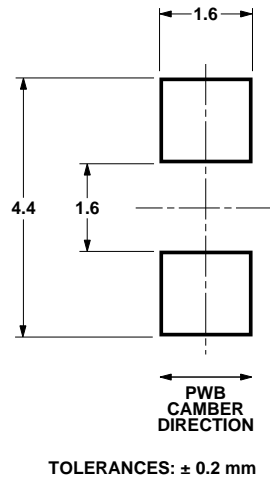
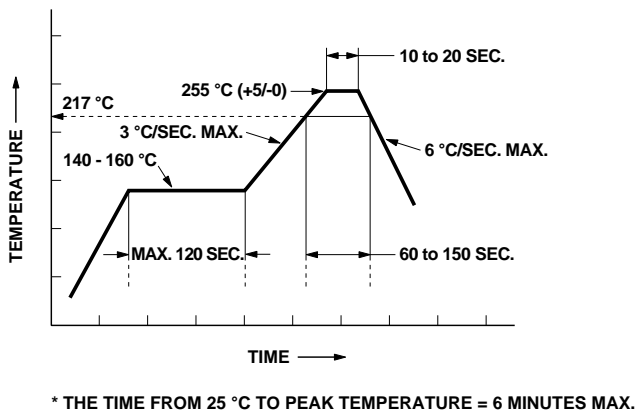

Figure 6. Recommended Pb-Free Reflow Soldering Profile.

Figure 7. Recommended Solder Patterns.

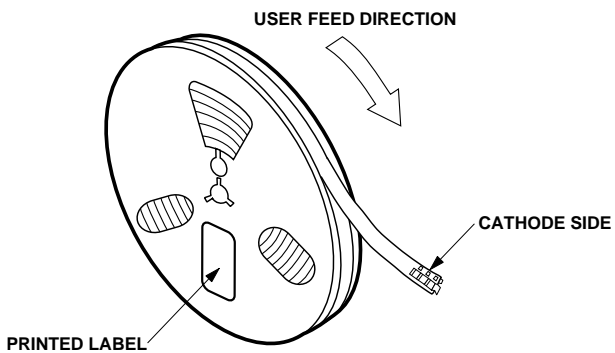

Figure 8. Reeling Orientation.

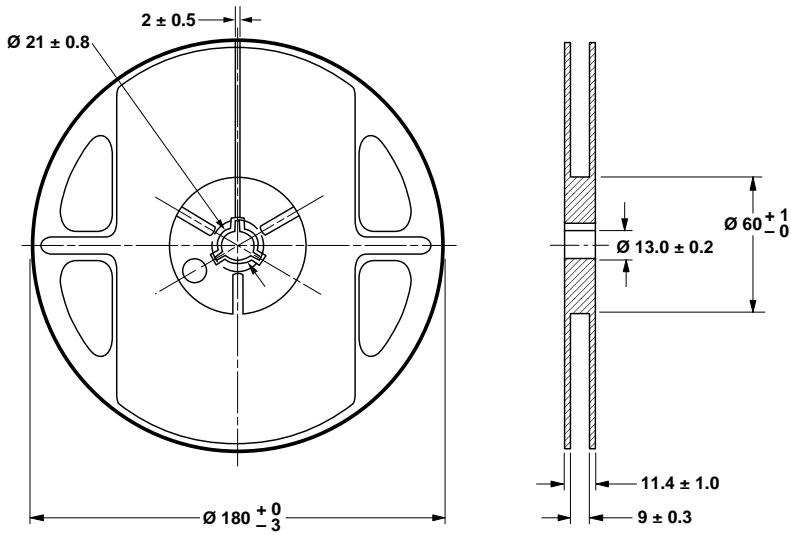

Figure 9. Reel Dimensions.

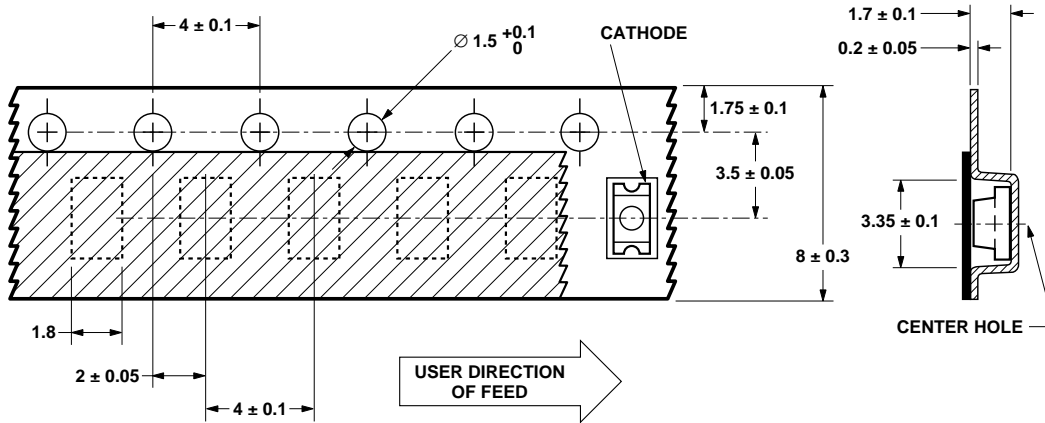

Figure 10. Tape Dimensions.

Storage Condition: 5 to 30° C @ 60% RH max.

Baking is required under the condition:

- a) the blue silica gel indicator becoming white/transparent color
- b) the pack has been opened for more than 1 week

Baking recommended condition: 60 +/- 5° C for 20 hours.

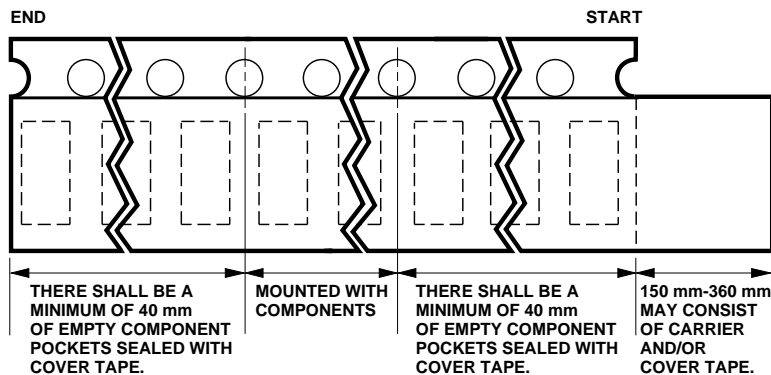

Figure 11. Tape Leader and Trailer Dimensions.

www.agilent.com/semiconductors

For product information and a complete list of distributors, please go to our web site.

For technical assistance call:

Americas/Canada: +1 (800) 235-0312 or
(916) 788-6763

Europe: +49 (0) 6441 92460

China: 10800 650 0017

Hong Kong: (+65) 6756 2394

India, Australia, New Zealand: (+65) 6755 1939

Japan: (+81 3) 3335-8152 (Domestic/International), or 0120-61-1280 (Domestic Only)

Korea: (+65) 6755 1989

Singapore, Malaysia, Vietnam, Thailand,
Philippines, Indonesia: (+65) 6755 2044

Taiwan: (+65) 6755 1843

Data subject to change.

Copyright © 2003 Agilent Technologies, Inc.



Obsoletes 5988-6272EN

November 13, 2003

5988-7315EN

Looking for pricing, stock, or lifecycle information?

Click below to explore more details on WIN SOURCE:

-  [View HSMG-L640 on WIN SOURCE](#)
-  [Broadcom Limited Information](#)

Optimize Your Supply Chain with WIN SOURCE Solutions

-  Global Sourcing Solution
-  Obsolete Management
-  Cost Control Management
-  Shortage Management
-  Alternative Solution
-  Excess Inventory Management