



**THE DATASHEET OF  
BYG20J/54**



## Ultrafast Avalanche SMD Rectifier

**SMA (DO-214AC)**

**RoHS**  
 COMPLIANT  
**HALOGEN**  
**FREE**  
 Available

### FEATURES

- Low profile package
- Ideal for automated placement
- Glass passivated pellet chip junction
- Low reverse current
- Soft recovery characteristics
- Ultrafast reverse recovery time
- Meets MSL level 1, per J-STD-020, LF maximum peak of 260 °C
- AEC-Q101 qualified available
  - Automotive ordering code: base P/NHE3 or P/NHM3
- Material categorization: for definitions of compliance please see [www.vishay.com/doc?99912](http://www.vishay.com/doc?99912)

### TYPICAL APPLICATIONS

For use in high frequency rectification of power supply, inverters, converters, and freewheeling diodes for consumer, automotive, and telecommunication.

### MECHANICAL DATA

**Case:** SMA (DO-214AC)

Molding compound meets UL 94 V-0 flammability rating

Base P/N-E3 - RoHS-compliant, commercial grade

Base P/N-M3 - halogen-free, RoHS-compliant, commercial grade

Base P/NHE3\_X - RoHS-compliant and AEC-Q101 qualified

Base P/NHM3\_X - halogen-free, RoHS-compliant and AEC-Q101 qualified

("\_X" denotes revision code e.g. A, B,...)

**Terminals:** matte tin plated leads, solderable per J-STD-002 and JESD 22-B102

E3, M3, HE3, HM3 suffix meet JESD 201 class 2 whisker test

**Polarity:** color band denotes the cathode end

PRIMARY CHARACTERISTICS	
$I_{F(AV)}$	1.5 A
$V_{RRM}$	200 V, 400 V, 600 V
$I_{FSM}$	30 A
$I_R$	1.0 $\mu$ A
$V_F$ at $I_F$	1.4 V
$t_{rr}$	75 ns
$E_R$	20 mJ
$T_J$ max.	150 °C
Package	SMA (DO-214AC)
Circuit configuration	Single

MAXIMUM RATINGS ( $T_A = 25$ °C unless otherwise noted)					
PARAMETER	SYMBOL	BYG20D	BYG20G	BYG20J	UNIT
Device marking code		BYG20D	BYG20G	BYG20J	
Maximum repetitive peak reverse voltage	$V_{RRM}$	200	400	600	V
Average forward current	$I_{F(AV)}$	1.5			A
Peak forward surge current 10 ms single half sine-wave superimposed on rated load	$I_{FSM}$	30			A
Pulse energy in avalanche mode, non repetitive (inductive load switch off) $I_{(BR)R} = 1$ A, $T_J = 25$ °C	$E_R$	20			mJ
Operating junction and storage temperature range	$T_J, T_{STG}$	-55 to +150			°C



<b>ELECTRICAL CHARACTERISTICS</b> ( $T_A = 25\text{ }^\circ\text{C}$ unless otherwise noted)							
PARAMETER	TEST CONDITIONS		SYMBOL	BYG20D	BYG20G	BYG20J	UNIT
Maximum instantaneous forward voltage	$I_F = 1\text{ A}$	$T_J = 25\text{ }^\circ\text{C}$	$V_F^{(1)}$	1.3			V
	$I_F = 1.5\text{ A}$			1.4			
Maximum DC reverse current	$V_R = V_{RRM}$	$T_J = 25\text{ }^\circ\text{C}$	$I_R$	1			$\mu\text{A}$
		$T_J = 100\text{ }^\circ\text{C}$		10			
Maximum reverse recovery time	$I_F = 0.5\text{ A}, I_R = 1.0\text{ A}, I_{rr} = 0.25\text{ A}$		$t_{rr}$	75			ns

**Note**(1) Pulse test: 300  $\mu\text{s}$  pulse width, 1 % duty cycle

<b>THERMAL CHARACTERISTICS</b> ( $T_A = 25\text{ }^\circ\text{C}$ unless otherwise noted)					
PARAMETER	SYMBOL	BYG20D	BYG20G	BYG20J	UNIT
Typical thermal resistance, junction to lead, $T_L = \text{const.}$	$R_{\theta JL}$	25			$^\circ\text{C/W}$
Typical thermal resistance, junction to ambient	$R_{\theta JA}^{(1)}$	150			$^\circ\text{C/W}$
	$R_{\theta JA}^{(2)}$	125			
	$R_{\theta JA}^{(3)}$	100			

**Notes**

- (1) Mounted on epoxy-glass hard tissue  
(2) Mounted on epoxy-glass hard tissue, 50 mm<sup>2</sup> 35  $\mu\text{m}$  Cu  
(3) Mounted on Al-oxide-ceramic (Al<sub>2</sub>O<sub>3</sub>), 50 mm<sup>2</sup> 35  $\mu\text{m}$  Cu

<b>ORDERING INFORMATION</b> (Example)				
PREFERRED P/N	UNIT WEIGHT (g)	PREFERRED PACKAGE CODE	BASE QUANTITY	DELIVERY MODE
BYG20J-E3/TR	0.064	TR	1800	7" diameter plastic tape and reel
BYG20J-E3/TR3	0.064	TR3	7500	13" diameter plastic tape and reel
BYG20JHE3_A/H <sup>(1)</sup>	0.064	H	1800	7" diameter plastic tape and reel
BYG20JHE3_A/I <sup>(1)</sup>	0.064	I	7500	13" diameter plastic tape and reel
BYG20J-M3/TR	0.064	TR	1800	7" diameter plastic tape and reel
BYG20J-M3/TR3	0.064	TR3	7500	13" diameter plastic tape and reel
BYG20JHM3_A/H <sup>(1)</sup>	0.064	H	1800	7" diameter plastic tape and reel
BYG20JHM3_A/I <sup>(1)</sup>	0.064	I	7500	13" diameter plastic tape and reel

**Note**

(1) AEC-Q101 qualified

## RATINGS AND CHARACTERISTICS CURVES ( $T_A = 25\text{ }^\circ\text{C}$ unless otherwise noted)

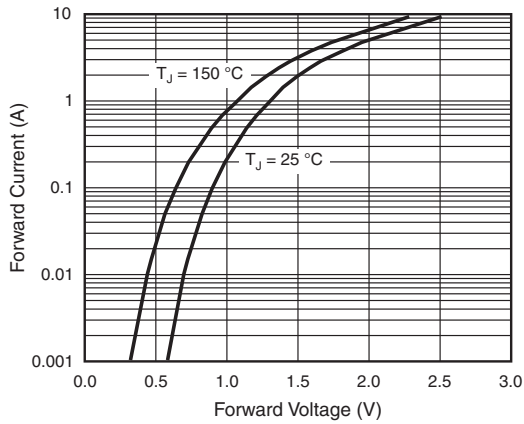

Fig. 1 - Forward Current vs. Forward Voltage

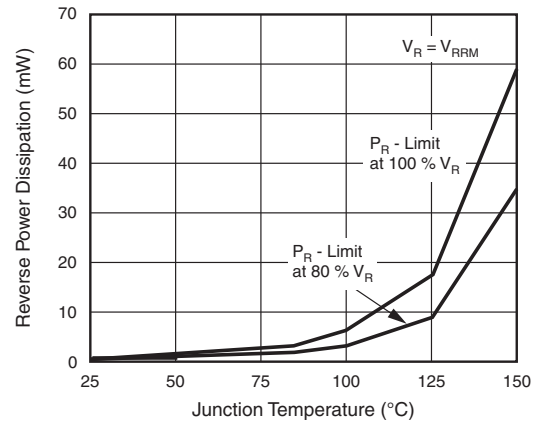

Fig. 4 - Max. Reverse Power Dissipation vs. Junction Temperature

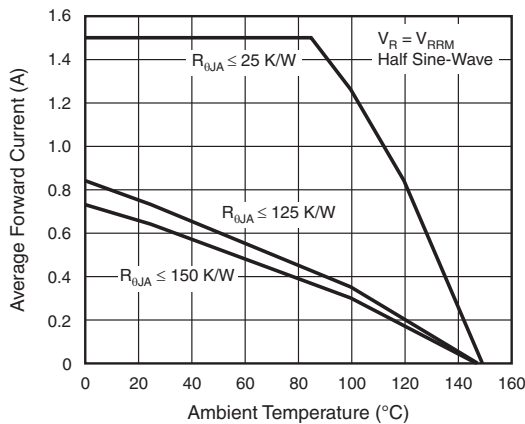

Fig. 2 - Max. Average Forward Current vs. Ambient Temperature

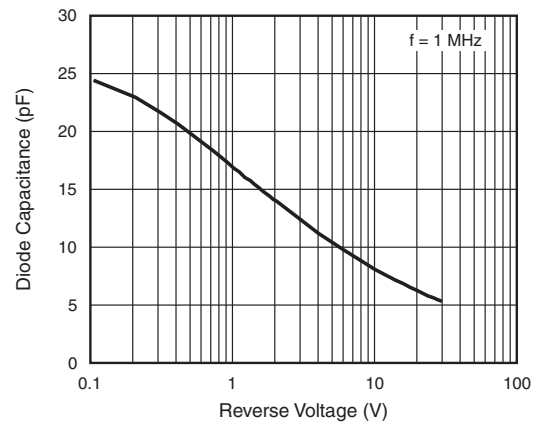

Fig. 5 - Diode Capacitance vs. Reverse Voltage

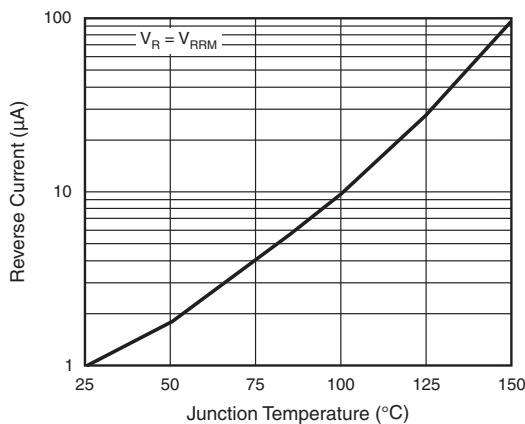

Fig. 3 - Reverse Current vs. Junction Temperature

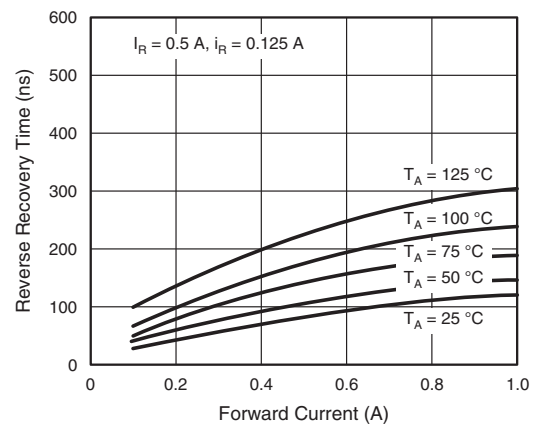

Fig. 6 - Reverse Recovery Time vs. Forward Current

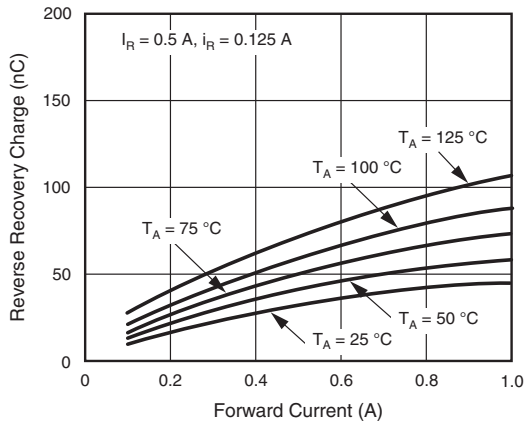

Fig. 7 - Reverse Recovery Charge vs. Forward Current

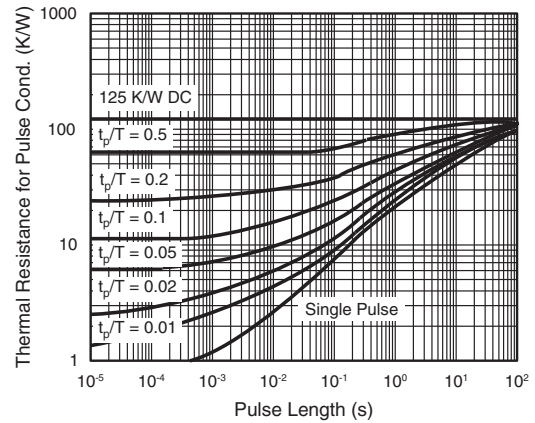
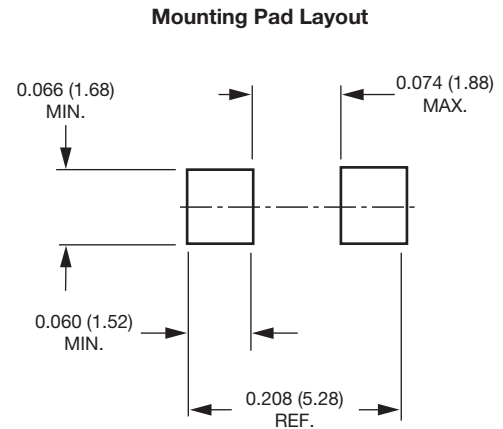
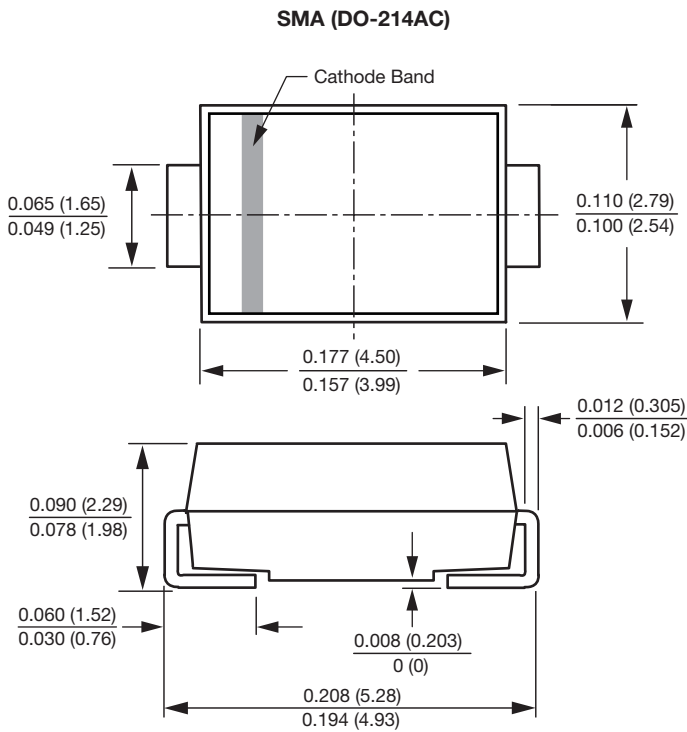

Fig. 8 - Thermal Response

### PACKAGE OUTLINE DIMENSIONS in inches (millimeters)





## **Disclaimer**

ALL PRODUCT, PRODUCT SPECIFICATIONS AND DATA ARE SUBJECT TO CHANGE WITHOUT NOTICE TO IMPROVE RELIABILITY, FUNCTION OR DESIGN OR OTHERWISE.

Vishay Intertechnology, Inc., its affiliates, agents, and employees, and all persons acting on its or their behalf (collectively, "Vishay"), disclaim any and all liability for any errors, inaccuracies or incompleteness contained in any datasheet or in any other disclosure relating to any product.

Vishay makes no warranty, representation or guarantee regarding the suitability of the products for any particular purpose or the continuing production of any product. To the maximum extent permitted by applicable law, Vishay disclaims (i) any and all liability arising out of the application or use of any product, (ii) any and all liability, including without limitation special, consequential or incidental damages, and (iii) any and all implied warranties, including warranties of fitness for particular purpose, non-infringement and merchantability.

Statements regarding the suitability of products for certain types of applications are based on Vishay's knowledge of typical requirements that are often placed on Vishay products in generic applications. Such statements are not binding statements about the suitability of products for a particular application. It is the customer's responsibility to validate that a particular product with the properties described in the product specification is suitable for use in a particular application. Parameters provided in datasheets and / or specifications may vary in different applications and performance may vary over time. All operating parameters, including typical parameters, must be validated for each customer application by the customer's technical experts. Product specifications do not expand or otherwise modify Vishay's terms and conditions of purchase, including but not limited to the warranty expressed therein.

Except as expressly indicated in writing, Vishay products are not designed for use in medical, life-saving, or life-sustaining applications or for any other application in which the failure of the Vishay product could result in personal injury or death. Customers using or selling Vishay products not expressly indicated for use in such applications do so at their own risk. Please contact authorized Vishay personnel to obtain written terms and conditions regarding products designed for such applications.

No license, express or implied, by estoppel or otherwise, to any intellectual property rights is granted by this document or by any conduct of Vishay. Product names and markings noted herein may be trademarks of their respective owners.

## Looking for pricing, stock, or lifecycle information?

Click below to explore more details on WIN SOURCE:

 [View BYG20J/54 on WIN SOURCE](#)

 [Vishay Information](#)

## Optimize Your Supply Chain with WIN SOURCE Solutions

-  Global Sourcing Solution
-  Obsolete Management
-  Cost Control Management
-  Shortage Management
-  Alternative Solution
-  Excess Inventory Management