

1 μ A Voltage Detector with Output Delay

Features

- Precise Detection Thresholds: $\pm 2.0\%$
- Small Package: 3-Pin SOT-23A
- Low Supply Current: Typ. 1 μ A
- Wide Detection Range: 1.6V to 6.0V
- Wide Operating Voltage Range: 0.7V to 10V
- Built-in Delay Circuit: 50msec to 200 msec
- Open-Drain Output

Applications

- Battery Voltage Monitoring
- Microprocessor Reset
- System Brown-out Protection

Device Selection Table

Part Number	Package	Temp. Range
TC51-xxxxxxxxx	3-Pin SOT-23A	-40°C to +85°C

Other output voltages are available. Please contact Microchip Technology Inc. for details.

Package Type

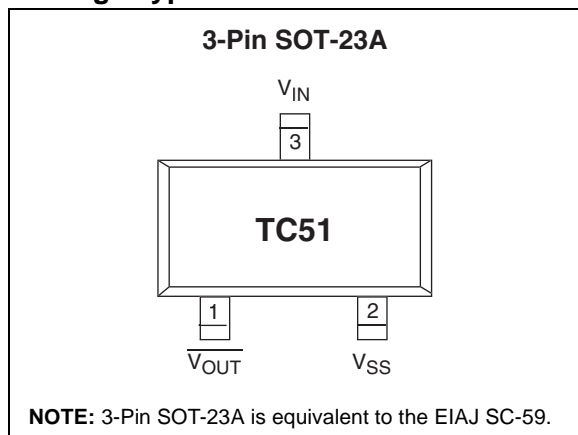

General Description

The TC51 is a very low power, open drain output, CMOS voltage detector with built-in delay. It is particularly well-suited for battery powered applications because of its extremely low 1 μ A operating current and small surface-mount packaging. Each part is laser-trimmed to the desired threshold voltage, which can be specified from 1.6V to 6.0V. The standard built-in output delay is 50msec-200msec.

The device includes a comparator, low-current high-precision reference, laser-programmed voltage divider, hysteresis circuit and output driver with digital delay timer.

In operation, the TC51's output ($\overline{V_{OUT}}$) remains in the logic HIGH state as long as V_{IN} is greater than the specified threshold voltage (V_{DET-}). When V_{IN} falls below V_{DET-} , the output is immediately driven to a logic LOW. $\overline{V_{OUT}}$ remains LOW until V_{IN} rises above V_{DET-} by an amount V_{HYST} , whereupon it returns to a logic HIGH after expiration of the built-in delay time.

Functional Block Diagram

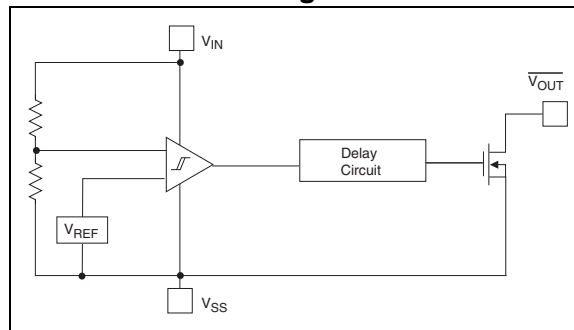

TC51

1.0 ELECTRICAL CHARACTERISTICS

Absolute Maximum Ratings*

Input Voltage+12V
 Output Current50mA
 Output Voltage: Open Drain($V_{SS} - 0.3V$) to 12V
 Power Dissipation ($T_A \leq 70^\circ C$):
 3-Pin SOT-23A240mW
 Operating Temperature Range.....-40°C to +85°C
 Storage Temperature Range-65°C to +150°C

*Stresses above those listed under "Absolute Maximum Ratings" may cause permanent damage to the device. These are stress ratings only and functional operation of the device at these or any other conditions above those indicated in the operation sections of the specifications is not implied. Exposure to Absolute Maximum Rating conditions for extended periods may affect device reliability.

TC51 ELECTRICAL SPECIFICATIONS

Electrical Characteristics: $T_A = 25^\circ C$, unless otherwise specified.						
Symbol	Parameter	Min	Typ	Max	Units	Test Conditions
V_{IN}	Operating Voltage	0.7	—	10.0	V	(V_{DET-}) = 1.6 to 6.0V
I_{SS}	Quiescent Current	—	0.9	2.6	μA	$V_{IN} = 1.5V$
		—	1.0	3.0		$V_{IN} = 2.0V$
		—	1.3	3.4		$V_{IN} = 3.0V$
		—	1.6	3.8		$V_{IN} = 4.0V$
		—	2.0	4.2		$V_{IN} = 5.0V$
V_{DET-}	Threshold Voltage	$V_T \times 0.98$	$V_T \pm 0.5\%$	$V_T \times 1.02$	V	Note 1
V_{HYST}	Hysteresis Voltage	$V_{DET-} \times 0.02$	$V_{DET-} \times 0.05$	$V_{DET-} \times 0.08$	V	
I_{OUT}	Output Current	—	2.2	—	mA	$V_{OL} = 0.5V, V_{IN} = 1.0V$
		—	7.7	—		$V_{IN} = 2.0V$
		—	10.1	—		$V_{IN} = 3.0V$
		—	11.5	—		$V_{IN} = 4.0V$
		—	13.0	—		$V_{IN} = 5.0V$
T_{DLY}	Delay Time	50	—	200	msec	Standard
$T_C (V_{DET-})$	Tempco of (V_{DET-})	—	± 100	—	ppm/ $^\circ C$	$-40^\circ C \leq T_A \leq 85^\circ C$

Note 1: V_T is the factory programmed threshold voltage setting.

2.0 PIN DESCRIPTIONS

The descriptions of the pins are listed in Table 2-1.

TABLE 2-1: PIN FUNCTION TABLE

Pin No. (3-Pin SOT-23A)	Symbol	Description
1	$\overline{V_{OUT}}$	Digital output. This output goes low when V_{IN} drops below V_{DET-} and returns high when V_{IN} rises above $V_{DET-} + V_{HYST}$. (See Figure 3-1, Timing Diagram).
2	V_{SS}	Ground terminal.
3	V_{IN}	Analog input. This pin is both the power supply input and the voltage to be monitored.

3.0 DETAILED DESCRIPTION

In normal steady-state operation, when $V_{IN} > V_{DET-}$, the output is high, see Figure 3-1. If and when the input falls below V_{DET-} , the output pulls down (Logic 0) to V_{SS} . Generally, V_{OUT} can pull down to within 0.5V of V_{SS} at rated output current and input voltage. (Also see Section 1.0, Electrical Characteristics).

The output, $\overline{V_{OUT}}$, stays valid until the input voltage falls below the minimum operating voltage, V_{INMIN} , of 0.7V. Below this minimum operating voltage, the output is undefined. During power-up or anytime V_{IN} has fallen below V_{INMIN} , $\overline{V_{OUT}}$ will remain undefined until V_{IN} rises above V_{INMIN} , at which time the output becomes valid. $\overline{V_{OUT}}$ is maintained in its active low state while $V_{INMIN} < V_{IN} < V_{DET+}$. ($V_{DET+} = V_{DET-} + V_{HYST}$). If and when the input rises above V_{DET+} , the output will assume its inactive state after Delay Time (T_{DLY}).

FIGURE 3-1: TIMING DIAGRAM

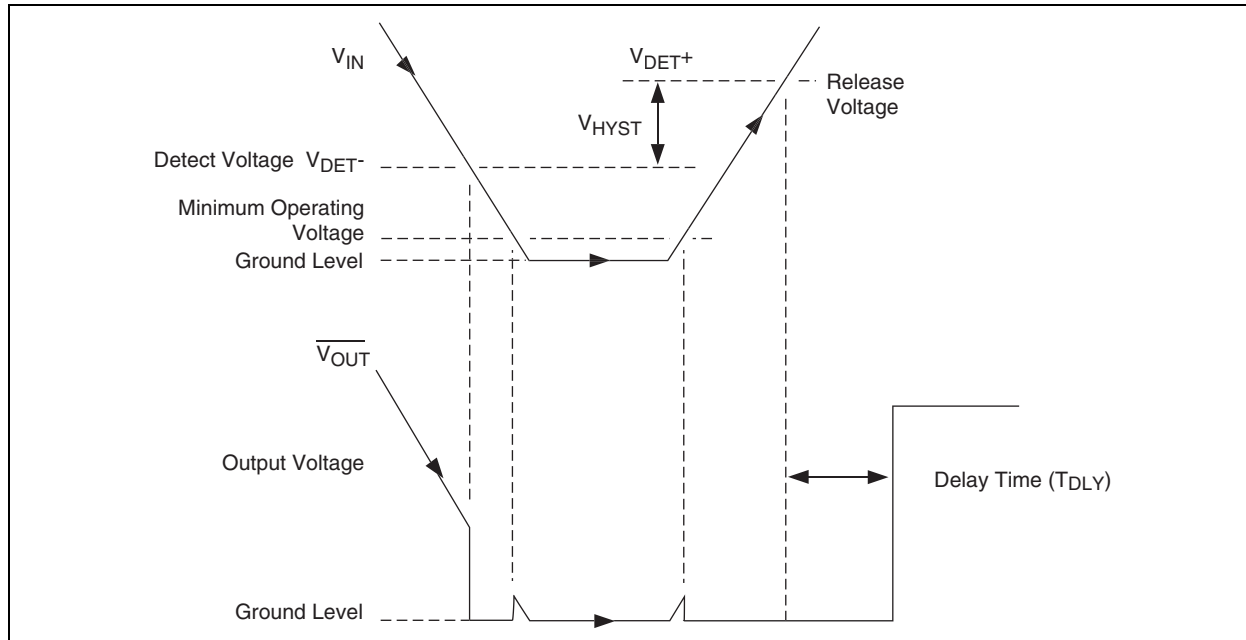

4.0 APPLICATIONS INFORMATION

4.1 Processor $\overline{\text{RESET}}$ Supervisor

Figure 4-1 shows the TC51 used as a processor reset supervisor. Because the TC51 is available in threshold settings of 1.6V to 6.0V, the user can choose the reset single threshold setting best suited to the system power supply voltage at hand. Also, the 1 μ A supply current is significantly lower than its nearest competitor.

As shown in the timing diagram (Figure 3-1), $\overline{\text{V}}_{\text{OUT}}$ is low for voltages between 0.7V and $\text{V}_{\text{DET}+}$. The TC51 activates its on-board delay timer once the power supply voltage is within tolerance (i.e., greater than $\text{V}_{\text{DET}+}$). $\overline{\text{V}}_{\text{OUT}}$ is released after delay time (T_{DLY}).

Should the power supply voltage momentarily dip (“brown-out” condition), the TC51 immediately drives and holds the processor $\overline{\text{RESET}}$ input low. $\overline{\text{RESET}}$ is released after the power supply voltage is again within tolerance, and after the delay timer expires. $\overline{\text{RESET}}$ is driven and held low when power fails (power-off or “blackout”), and is maintained down low to a supply voltage of 0.7V.

FIGURE 4-1: PROCESSOR $\overline{\text{RESET}}$ SUPERVISOR

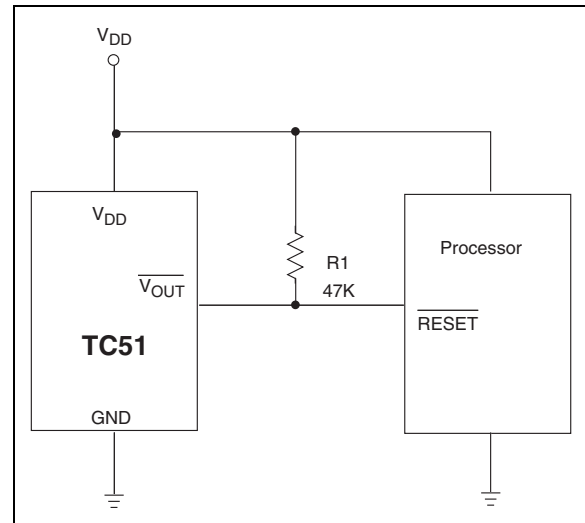
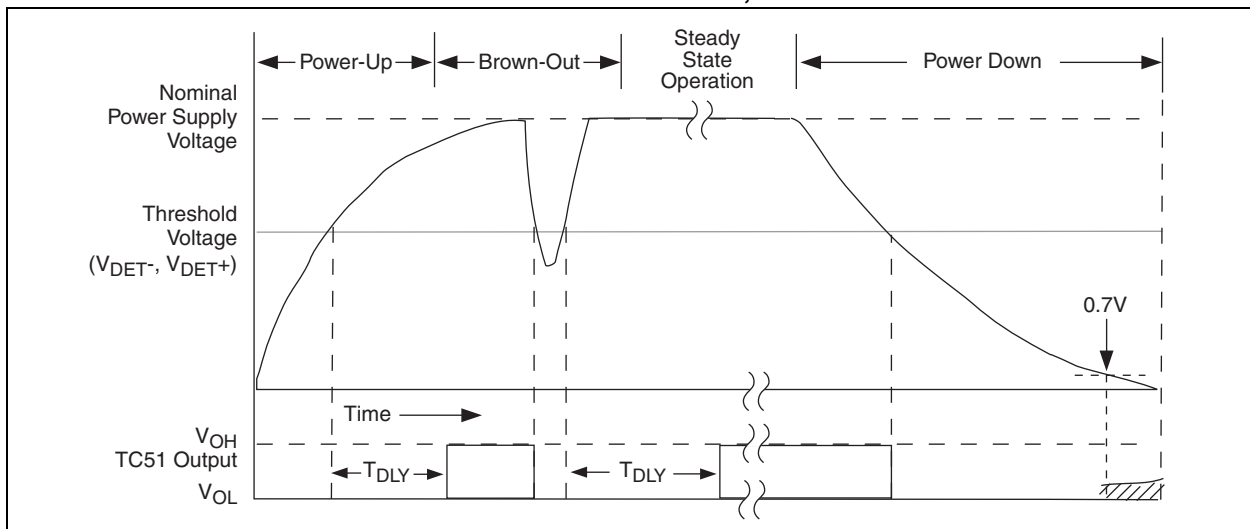

FIGURE 4-2: TC51 OPERATION DURING POWER-UP, BROWN-OUT AND POWER DOWN



TC51

5.0 TYPICAL CHARACTERISTICS

Note: The graphs and tables provided following this note are a statistical summary based on a limited number of samples and are provided for informational purposes only. The performance characteristics listed herein are not tested or guaranteed. In some graphs or tables, the data presented may be outside the specified operating range (e.g., outside specified power supply range) and therefore outside the warranted range.

1. SUPPLY CURRENT VS. INPUT VOLTAGE

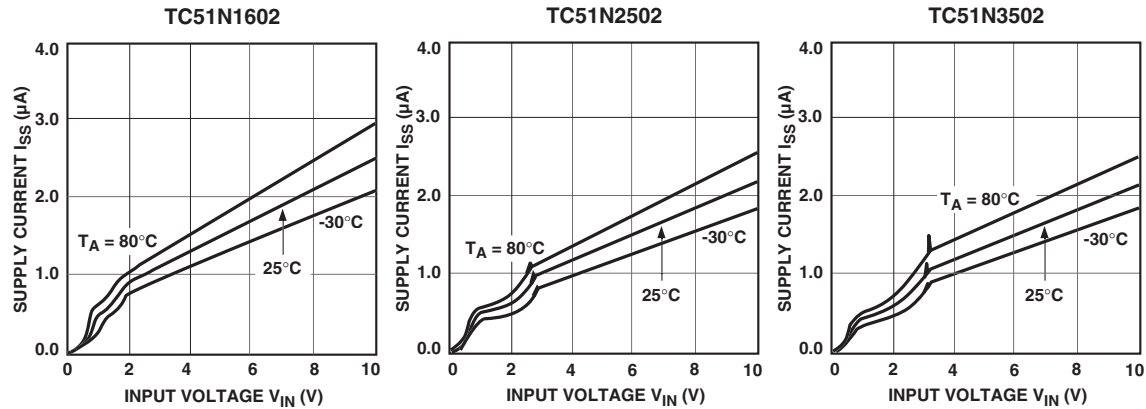

2. THRESHOLD VOLTAGE, HYSTERESIS VOLTAGE VS. AMBIENT TEMPERATURE

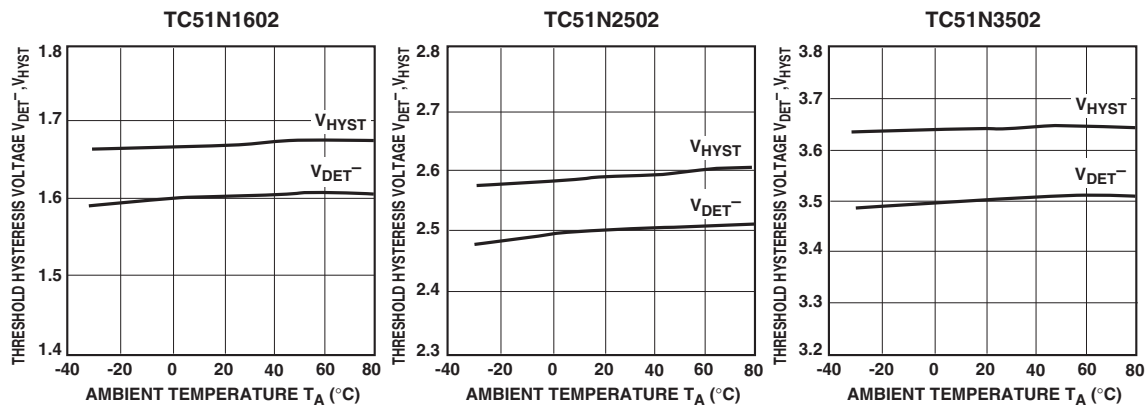

3. OUTPUT VOLTAGE VS. INPUT VOLTAGE

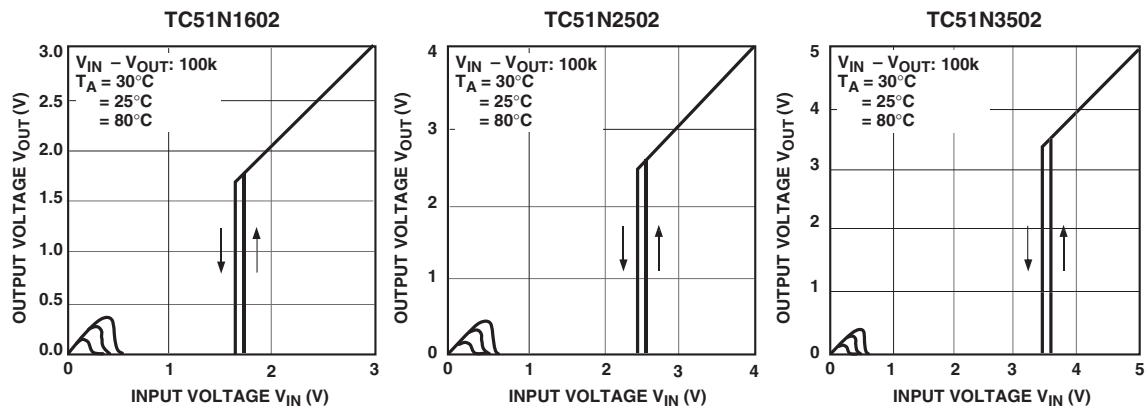

5.0 TYPICAL CHARACTERISTICS (CONTINUED)

4. OUTPUT CURRENT VS. V_{DS}

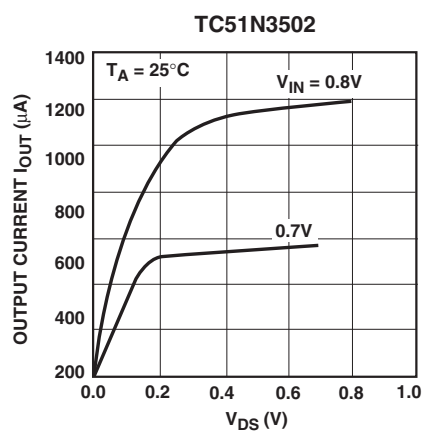
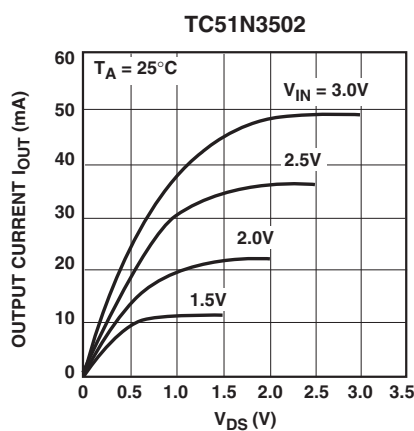
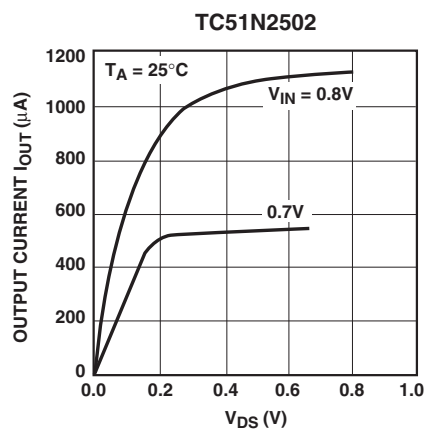
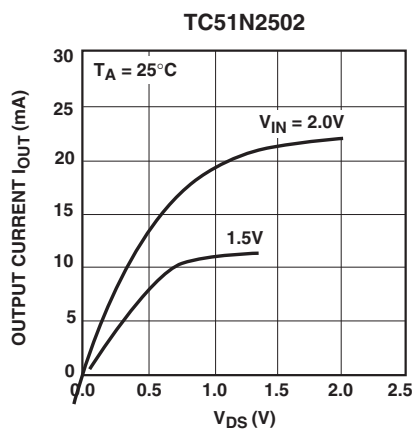
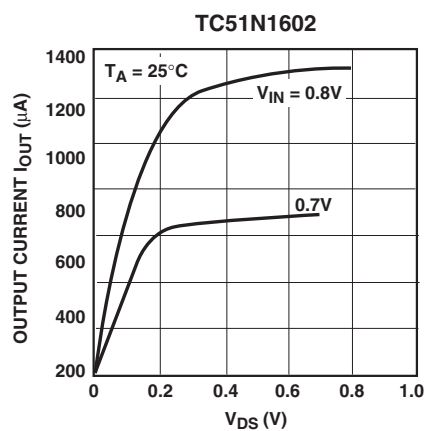
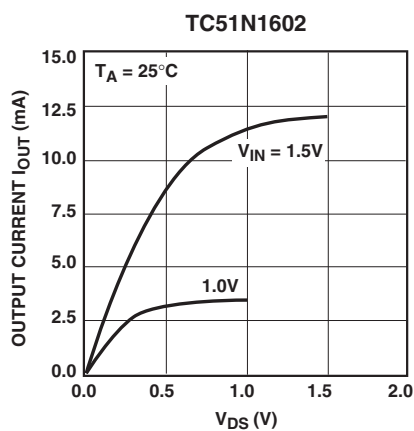

5.0 TYPICAL CHARACTERISTICS (CONTINUED)

5. OUTPUT CURRENT VS. INPUT VOLTAGE

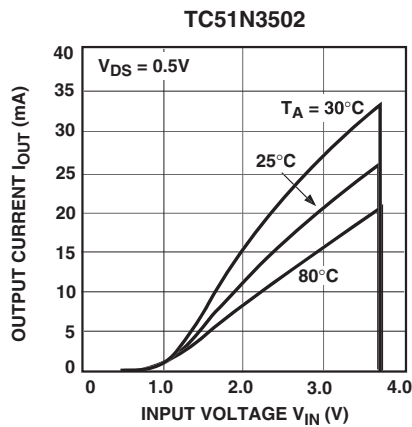
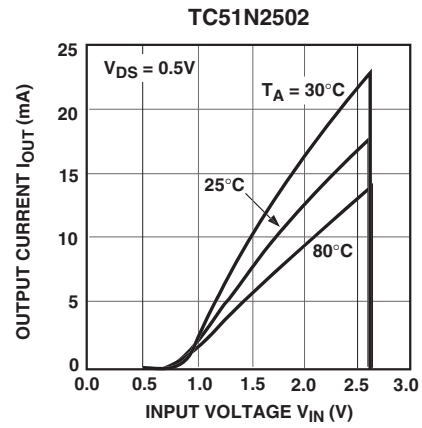
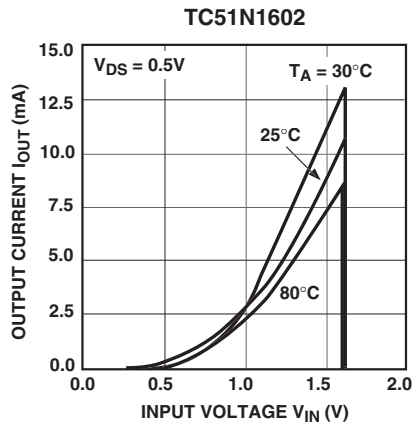

6.0 PACKAGING INFORMATION

6.1 Package Marking Information

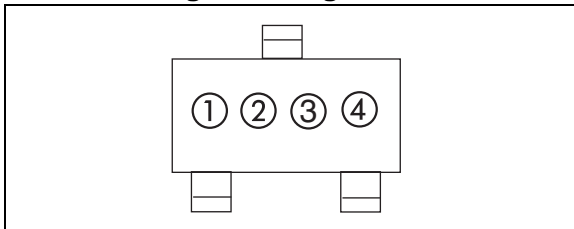

① represents N-channel indication and integer part of output voltage

Symbol	Output	Voltage
K	Nch	0.
L	Nch	1.
M	Nch	2.
N	Nch	3.
P	Nch	4.
R	Nch	5.
S	Nch	6.

② represents first decimal of output voltage

Symbol	Voltage
0	.0
1	.1
2	.2
3	.3
4	.4
5	.5
6	.6
7	.7
8	.8
9	.9

③ represents delay time

Symbol	Delay Time
5	50ms-200ms

④ represents assembly lot code

6.2 Taping Form

Component Taping Orientation for 3-Pin SOT-23A (EIAJ SC-59) Devices

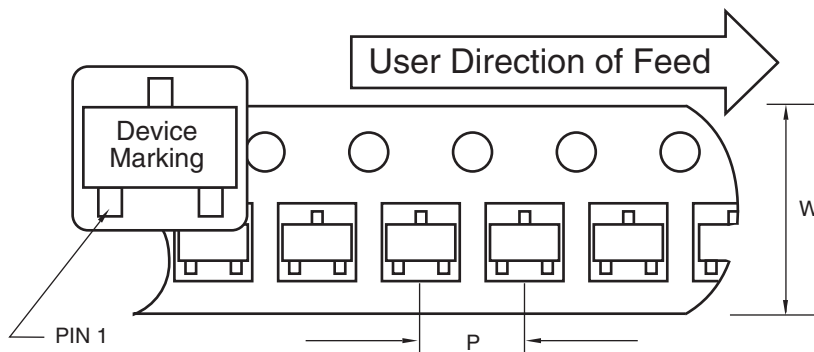

Standard Reel Component Orientation
for TR Suffix Device
(Mark Right Side Up)

Carrier Tape, Number of Components Per Reel and Reel Size

Package	Carrier Width (W)	Pitch (P)	Part Per Full Reel	Reel Size
3-Pin SOT-23A	8 mm	4 mm	3000	7 in

6.3 Package Dimensions

Note: For the most current package drawings, please see the Microchip Packaging Specification located at <http://www.microchip.com/packaging>

SOT-23A-3

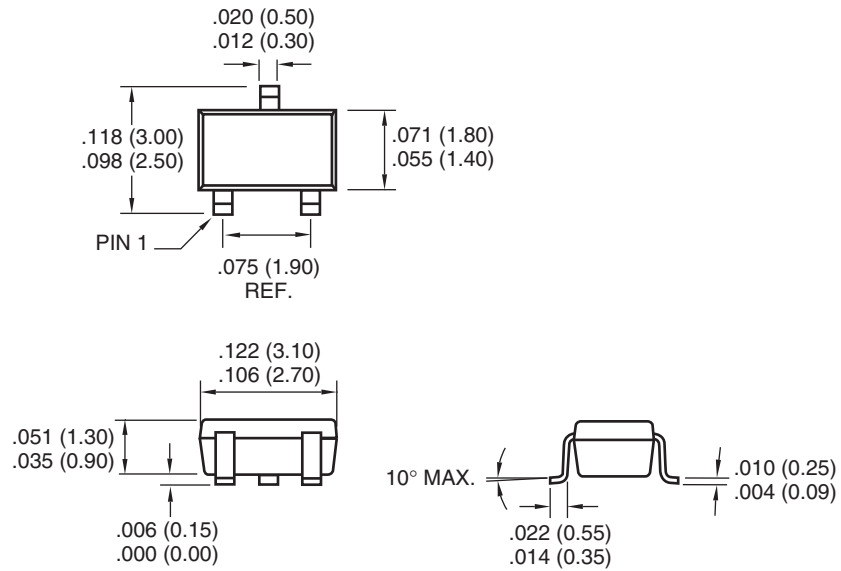

Dimensions: inches (mm)

7.0 REVISION HISTORY

Revision C (December 2012)

Added a note to the package outline drawing.

TC51

NOTES:

PRODUCT IDENTIFICATION SYSTEM

To order or obtain information, e.g., on pricing or delivery, refer to the factory or the listed sales office.

PART CODE	TC51	N	18	0	2	E	CB	XX
Output Configuration:								
N = Open Drain								
Detected Voltage:								
Ex: 18 = 1.8V								
Output Delay:								
0 = 50msec-200msec (standard)								
Tolerance:								
2 = $\pm 2\%$								
Temperature:								
E: -40°C to +85°C								
Package Type and Pin Count:								
CB: 3-Pin SOT-23A (equivalent to EIAJ SC-59)								
Taping Direction:								
TR: Standard Taping								

Sales and Support

Data Sheets

Products supported by a preliminary Data Sheet may have an errata sheet describing minor operational differences and recommended workarounds. To determine if an errata sheet exists for a particular device, please contact one of the following:

1. Your local Microchip sales office
2. The Microchip Worldwide Site (www.microchip.com)

Please specify which device, revision of silicon and Data Sheet (include Literature #) you are using.

New Customer Notification System

Register on our web site (www.microchip.com/cn) to receive the most current information on our products.

TC51

NOTES:

Note the following details of the code protection feature on Microchip devices:

- Microchip products meet the specification contained in their particular Microchip Data Sheet.
- Microchip believes that its family of products is one of the most secure families of its kind on the market today, when used in the intended manner and under normal conditions.
- There are dishonest and possibly illegal methods used to breach the code protection feature. All of these methods, to our knowledge, require using the Microchip products in a manner outside the operating specifications contained in Microchip's Data Sheets. Most likely, the person doing so is engaged in theft of intellectual property.
- Microchip is willing to work with the customer who is concerned about the integrity of their code.
- Neither Microchip nor any other semiconductor manufacturer can guarantee the security of their code. Code protection does not mean that we are guaranteeing the product as “unbreakable.”

Code protection is constantly evolving. We at Microchip are committed to continuously improving the code protection features of our products. Attempts to break Microchip's code protection feature may be a violation of the Digital Millennium Copyright Act. If such acts allow unauthorized access to your software or other copyrighted work, you may have a right to sue for relief under that Act.

Information contained in this publication regarding device applications and the like is provided only for your convenience and may be superseded by updates. It is your responsibility to ensure that your application meets with your specifications. MICROCHIP MAKES NO REPRESENTATIONS OR WARRANTIES OF ANY KIND WHETHER EXPRESS OR IMPLIED, WRITTEN OR ORAL, STATUTORY OR OTHERWISE, RELATED TO THE INFORMATION, INCLUDING BUT NOT LIMITED TO ITS CONDITION, QUALITY, PERFORMANCE, MERCHANTABILITY OR FITNESS FOR PURPOSE. Microchip disclaims all liability arising from this information and its use. Use of Microchip devices in life support and/or safety applications is entirely at the buyer's risk, and the buyer agrees to defend, indemnify and hold harmless Microchip from any and all damages, claims, suits, or expenses resulting from such use. No licenses are conveyed, implicitly or otherwise, under any Microchip intellectual property rights.

Trademarks

The Microchip name and logo, the Microchip logo, dsPIC, FlashFlex, KEELOQ, KEELOQ logo, MPLAB, PIC, PICmicro, PICSTART, PIC³² logo, rPIC, SST, SST Logo, SuperFlash and UNI/O are registered trademarks of Microchip Technology Incorporated in the U.S.A. and other countries.

FilterLab, Hampshire, HI-TECH C, Linear Active Thermistor, MTP, SEEVAL and The Embedded Control Solutions Company are registered trademarks of Microchip Technology Incorporated in the U.S.A.

Silicon Storage Technology is a registered trademark of Microchip Technology Inc. in other countries.

Analog-for-the-Digital Age, Application Maestro, BodyCom, chipKIT, chipKIT logo, CodeGuard, dsPICDEM, dsPICDEM.net, dsPICworks, dsSPEAK, ECAN, ECONOMONITOR, FanSense, HI-TIDE, In-Circuit Serial Programming, ICSP, Mindi, MiWi, MPASM, MPF, MPLAB Certified logo, MPLIB, MPLINK, mTouch, Omniclient Code Generation, PICC, PICC-18, PICDEM, PICDEM.net, PICkit, PICTail, REAL ICE, rLAB, Select Mode, SQI, Serial Quad I/O, Total Endurance, TSHARC, UniWinDriver, WiperLock, ZENA and Z-Scale are trademarks of Microchip Technology Incorporated in the U.S.A. and other countries.

SQTP is a service mark of Microchip Technology Incorporated in the U.S.A.

GestIC and ULPP are registered trademarks of Microchip Technology Germany II GmbH & Co. & KG, a subsidiary of Microchip Technology Inc., in other countries.

All other trademarks mentioned herein are property of their respective companies.

© 2002-2012, Microchip Technology Incorporated, Printed in the U.S.A., All Rights Reserved.

 Printed on recycled paper.

ISBN: 9781620768013

QUALITY MANAGEMENT SYSTEM
CERTIFIED BY DNV
== ISO/TS 16949 ==

Microchip received ISO/TS-16949:2009 certification for its worldwide headquarters, design and wafer fabrication facilities in Chandler and Tempe, Arizona; Gresham, Oregon and design centers in California and India. The Company's quality system processes and procedures are for its PIC[®] MCUs and dsPIC[®] DSCs, KEELOQ[®] code hopping devices, Serial EEPROMs, microperipherals, nonvolatile memory and analog products. In addition, Microchip's quality system for the design and manufacture of development systems is ISO 9001:2000 certified.



MICROCHIP

Worldwide Sales and Service

AMERICAS

Corporate Office
2355 West Chandler Blvd.
Chandler, AZ 85224-6199
Tel: 480-792-7200
Fax: 480-792-7277
Technical Support:
<http://www.microchip.com/support>
Web Address:
www.microchip.com

Atlanta
Duluth, GA
Tel: 678-957-9614
Fax: 678-957-1455

Boston
Westborough, MA
Tel: 774-760-0087
Fax: 774-760-0088

Chicago
Itasca, IL
Tel: 630-285-0071
Fax: 630-285-0075

Cleveland
Independence, OH
Tel: 216-447-0464
Fax: 216-447-0643

Dallas
Addison, TX
Tel: 972-818-7423
Fax: 972-818-2924

Detroit
Farmington Hills, MI
Tel: 248-538-2250
Fax: 248-538-2260

Indianapolis
Noblesville, IN
Tel: 317-773-8323
Fax: 317-773-5453

Los Angeles
Mission Viejo, CA
Tel: 949-462-9523
Fax: 949-462-9608

Santa Clara
Santa Clara, CA
Tel: 408-961-6444
Fax: 408-961-6445

Toronto
Mississauga, Ontario,
Canada
Tel: 905-673-0699
Fax: 905-673-6509

ASIA/PACIFIC

Asia Pacific Office
Suites 3707-14, 37th Floor
Tower 6, The Gateway
Harbour City, Kowloon
Hong Kong
Tel: 852-2401-1200
Fax: 852-2401-3431

Australia - Sydney
Tel: 61-2-9868-6733
Fax: 61-2-9868-6755

China - Beijing
Tel: 86-10-8569-7000
Fax: 86-10-8528-2104

China - Chengdu
Tel: 86-28-8665-5511
Fax: 86-28-8665-7889

China - Chongqing
Tel: 86-23-8980-9588
Fax: 86-23-8980-9500

China - Hangzhou
Tel: 86-571-2819-3187
Fax: 86-571-2819-3189

China - Hong Kong SAR
Tel: 852-2943-5100
Fax: 852-2401-3431

China - Nanjing
Tel: 86-25-8473-2460
Fax: 86-25-8473-2470

China - Qingdao
Tel: 86-532-8502-7355
Fax: 86-532-8502-7205

China - Shanghai
Tel: 86-21-5407-5533
Fax: 86-21-5407-5066

China - Shenyang
Tel: 86-24-2334-2829
Fax: 86-24-2334-2393

China - Shenzhen
Tel: 86-755-8864-2200
Fax: 86-755-8203-1760

China - Wuhan
Tel: 86-27-5980-5300
Fax: 86-27-5980-5118

China - Xian
Tel: 86-29-8833-7252
Fax: 86-29-8833-7256

China - Xiamen
Tel: 86-592-2388138
Fax: 86-592-2388130

China - Zhuhai
Tel: 86-756-3210040
Fax: 86-756-3210049

ASIA/PACIFIC

India - Bangalore
Tel: 91-80-3090-4444
Fax: 91-80-3090-4123

India - New Delhi
Tel: 91-11-4160-8631
Fax: 91-11-4160-8632

India - Pune
Tel: 91-20-2566-1512
Fax: 91-20-2566-1513

Japan - Osaka
Tel: 81-66-152-7160
Fax: 81-66-152-9310

Japan - Yokohama
Tel: 81-45-471-6166
Fax: 81-45-471-6122

Korea - Daegu
Tel: 82-53-744-4301
Fax: 82-53-744-4302

Korea - Seoul
Tel: 82-2-554-7200
Fax: 82-2-558-5932 or
82-2-558-5934

Malaysia - Kuala Lumpur
Tel: 60-3-6201-9857
Fax: 60-3-6201-9859

Malaysia - Penang
Tel: 60-4-227-8870
Fax: 60-4-227-4068

Philippines - Manila
Tel: 63-2-634-9065
Fax: 63-2-634-9069

Singapore
Tel: 65-6334-8870
Fax: 65-6334-8850

Taiwan - Hsin Chu
Tel: 886-3-5778-366
Fax: 886-3-5770-955

Taiwan - Kaohsiung
Tel: 886-7-213-7828
Fax: 886-7-330-9305

Taiwan - Taipei
Tel: 886-2-2508-8600
Fax: 886-2-2508-0102

Thailand - Bangkok
Tel: 66-2-694-1351
Fax: 66-2-694-1350

EUROPE

Austria - Wels
Tel: 43-7242-2244-39
Fax: 43-7242-2244-393

Denmark - Copenhagen
Tel: 45-4450-2828
Fax: 45-4485-2829

France - Paris
Tel: 33-1-69-53-63-20
Fax: 33-1-69-30-90-79

Germany - Munich
Tel: 49-89-627-144-0
Fax: 49-89-627-144-44

Italy - Milan
Tel: 39-0331-742611
Fax: 39-0331-466781

Netherlands - Drunen
Tel: 31-416-690399
Fax: 31-416-690340



Spain - Madrid
Tel: 34-91-708-08-90
Fax: 34-91-708-08-91

UK - Wokingham
Tel: 44-118-921-5869
Fax: 44-118-921-5820

11/27/12

Looking for pricing, stock, or lifecycle information?

Click below to explore more details on WIN SOURCE:

-  [View TC51N2202ECBTR on WIN SOURCE](#)
-  [Microchip Technology](#) Information

Optimize Your Supply Chain with WIN SOURCE Solutions

-  Global Sourcing Solution
-  Obsolete Management
-  Cost Control Management
-  Shortage Management
-  Alternative Solution
-  Excess Inventory Management