



# THE DATASHEET OF CAT32TDI-GT3



# CAT32

## CMOS White LED Driver

### Description

The CAT32 is a DC/DC step up converter that delivers a regulated output current. Operation at a constant switching frequency of 1.2 MHz allows the device to be used with very small value external inductor and ceramic capacitors.

The CAT32 is targeted to drive multiple white light-emitting diodes (LEDs) connected in series and provides the necessary regulated current to control the brightness and the color purity. An external resistor  $R_{SET}$  controls the output current level. LED currents of up to 40 mA can be supported over a wide range of input supply voltages from 2 V to 7 V, making the device ideal for battery-powered applications.

A high voltage output stage allows up to 4 White LEDs to be driven in series. Series drive provides inherent current matching.

LED dimming can be done by using a DC voltage, a logic signal, or a pulse width modulation (PWM) signal. The shutdown input pin allows the device to be placed in power-down mode with “near zero” quiescent current.

In addition to overcurrent limiting protection, the device also includes detection circuitry to ensure protection against open-circuit load fault conditions.

The device is available in a low profile (1 mm max height) 6-lead TSOT-23 package.

### Features

- Low Quiescent Ground Current (0.5 mA Typical)
- Power Efficiency Over 80%
- Compatible Pinout with LT1932
- Adjustable Output Current (up to 40 mA)
- High Frequency 1.2 MHz Operation
- Input Voltage Operation down to 2.0 V
- Low Resistance (0.5  $\Omega$ ) High Voltage Power Switch
- Drives up to 4 White LEDs in Series
- Shutdown Current Less than 1  $\mu$ A
- Load Fault Protection Against Open-circuits
- Low Value External Components
- Low Profile (1 mm) TSOT-23 6-lead Package
- These Devices are Pb-Free, Halogen Free/BFR Free and are RoHS Compliant

### Applications

- Color LCD and Keypad Backlighting
- Cellular Phones
- Handheld Terminals
- Digital Cameras
- PDAs/Games
- Portable MP3 Players



ON Semiconductor®

<http://onsemi.com>



1

TSOT-23  
TD SUFFIX  
CASE 419AF

### PIN CONNECTIONS

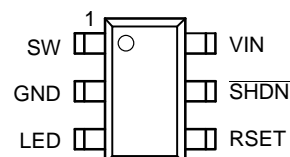

TSOT-23  
1 mm Maximum Height  
 $\theta_{JA} = 250^{\circ}\text{C/W}$  (free air)

(Top View)

### MARKING DIAGRAMS

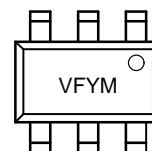

VF = CAT32TDI-GT3  
Y = Production Year (Last Digit)  
M = Production Month (1-9, A, B, C)

### ORDERING INFORMATION

Device	Package	Shipping
CAT32TDI-GT3	TSOT-23 (Pb-Free)	3,000/ Tape & Reel

# CAT32

## Typical Application Circuit

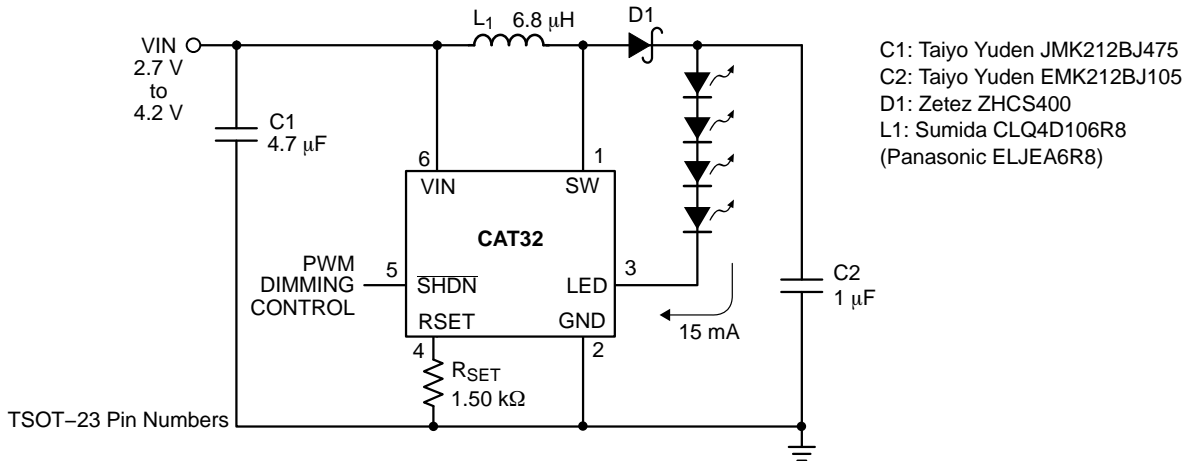

Figure 1. Li-Ion Driver for Four High-Brightness White LEDs

Table 1. PIN DESCRIPTION

Pin Number SOT23	Pin Number TDFN	Name	Function
1	8	SW	Switch pin. This is the drain of the internal power switch. For minimum EMI, minimize the trace area connected to this pin.
2	5	GND	Ground pin. Connect pin 2 to ground.
3	6	LED	LED (cathode) connection pin.
4	4	RSET	RESET pin. A resistor connected from pin 4 to ground sets the LED current. This pin is also used to dim the LEDs.
5	3	$\overline{\text{SHDN}}$	Shutdown pin.
6	2	VIN	Input supply pin. This pin should be bypassed with a capacitor to ground. A 4.7 $\mu\text{F}$ capacitor mounted close to the pin is recommended.
-	1	Power Ground	Power Ground

# CAT32

**Table 2. ABSOLUTE MAXIMUM RATINGS**

Parameter	Rating	Unit
V <sub>IN</sub> , LED, $\overline{\text{SHDN}}$ voltage	8	V
SW voltage	20	V
RSET voltage	1	V
Storage Temperature Range	-65 to +150	°C
Junction Temperature	125	°C
Lead Soldering Temperature (10 secs)	300	°C
ESD Rating – Human Body Model	2000	V

Stresses exceeding those listed in the Maximum Ratings table may damage the device. If any of these limits are exceeded, device functionality should not be assumed, damage may occur and reliability may be affected.

**Table 3. RECOMMENDED OPERATING CONDITIONS**

Parameter	Range	Unit
V <sub>IN</sub>	2 to 7	V
Ambient Temperature Range	-40 to +85	°C
Inductor L1	6.8 ±20% typical	μH
Input Capacitor C1	4.7 ±20% typical	μF
Output Capacitor C2	1.0 ±20% typical	μF
I <sub>LED</sub> with 1 to 4 LEDs in series	0 to 20	mA

Functional operation above the stresses listed in the Recommended Operating Ranges is not implied. Extended exposure to stresses beyond the Recommended Operating Ranges limits may affect device reliability.

NOTE: Typical application circuit with external components is shown on page 2.

**Table 4. ELECTRICAL OPERATING CHARACTERISTICS**

(Over recommended operating conditions unless otherwise specified. T<sub>A</sub> = 25°C, V<sub>IN</sub> = 2 V and  $\overline{\text{VSHDN}}$  = 1.2 V.)

Symbol	Parameter	Conditions	Min	Typ	Max	Unit
I <sub>Q</sub>	Quiescent Current	V <sub>RSET</sub> = 0.2 V		0.5	0.7	mA
I <sub>GND</sub>	Ground Current in Shutdown	$\overline{\text{VSHDN}}$ = 0 V		0.05	1	μA
V <sub>LED</sub>	LED Pin Voltage	V <sub>IN</sub> < V <sub>OUT</sub> , I <sub>LED</sub> = 15 mA		120	180	mV
I <sub>LED</sub>	LED Current Adjust Range		5		40	mA
I <sub>LED</sub>	Programmed LED Current	R <sub>SET</sub> = 562 Ω	33	38	45	mA
		R <sub>SET</sub> = 750 Ω	25	30	36	
		R <sub>SET</sub> = 1.5 kΩ	12.5	15	17.5	
		R <sub>SET</sub> = 4.53 kΩ		5		
I <sub>LED</sub>	LED Pin Current Temperature Coefficient	I <sub>LED</sub> = 15 mA		-0.01		mA/°C
V <sub>RSET</sub>	RSET Pin Voltage	R <sub>SET</sub> = 1.5 kΩ		100		mV
	Shutdown Pin Logic High Level		0.85			V
	Shutdown Pin Logic Low Level				0.25	V
f <sub>SW</sub>	Boost Converter Frequency		0.8	1.2	1.6	MHz
I <sub>SWL</sub>	Switch Current Limit		400	550	780	mA
R <sub>SW</sub>	Switch Resistance	V <sub>IN</sub> = 2 V, I <sub>SW</sub> = 100 mA		0.7	1.2	Ω
		V <sub>IN</sub> = 3 V, I <sub>SW</sub> = 100 mA		0.5	0.9	
	Switch Leakage Current	Switch Off, V <sub>SW</sub> = 5 V		0.01	5	μA
	Efficiency	Components shown on Figure 1		83		%

Product parametric performance is indicated in the Electrical Characteristics for the listed test conditions, unless otherwise noted. Product performance may not be indicated by the Electrical Characteristics if operated under different conditions.

# CAT32

## TYPICAL CHARACTERISTICS

( $V_{IN} = 3.6\text{ V}$ ,  $T_{AMB} = 25^\circ\text{C}$ ,  $C_{IN} = 4.7\ \mu\text{F}$ ,  $C_{OUT} = 1\ \mu\text{F}$ ,  $L = 6.8\ \mu\text{H}$ , unless otherwise specified.)

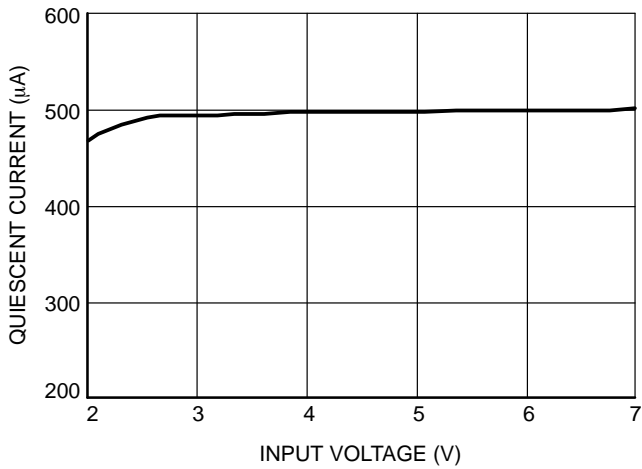

Figure 2. Quiescent Current vs. Input Voltage

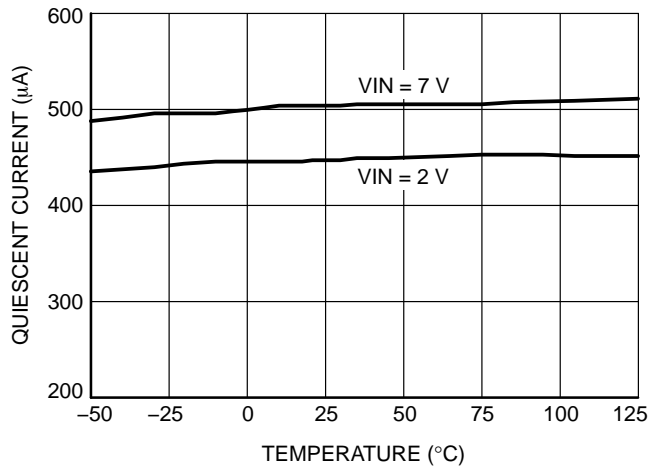

Figure 3. Quiescent Current vs. Temperature

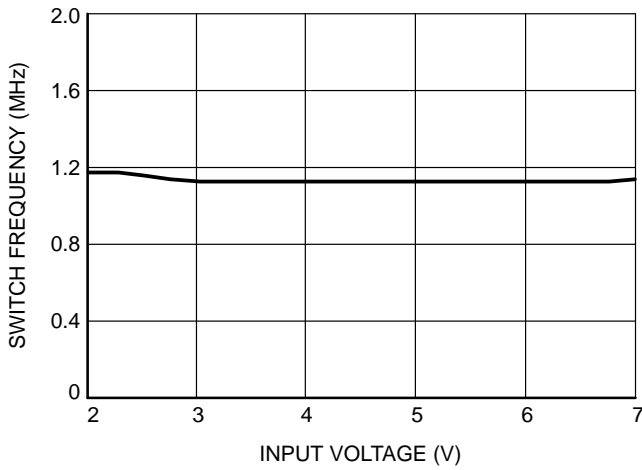

Figure 4. Switching Frequency vs. Input Voltage

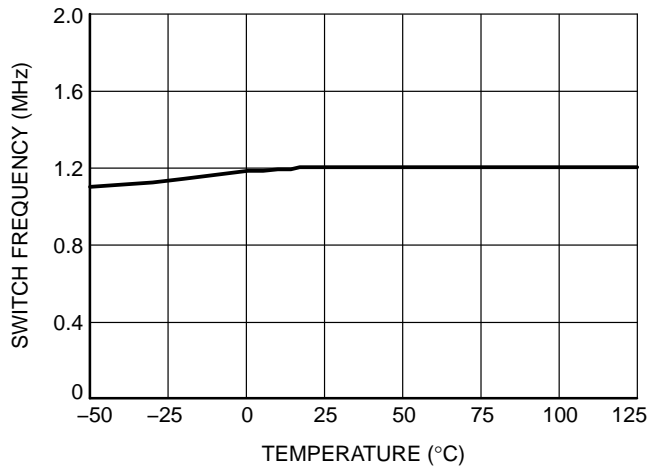

Figure 5. Switching Frequency vs. Temperature

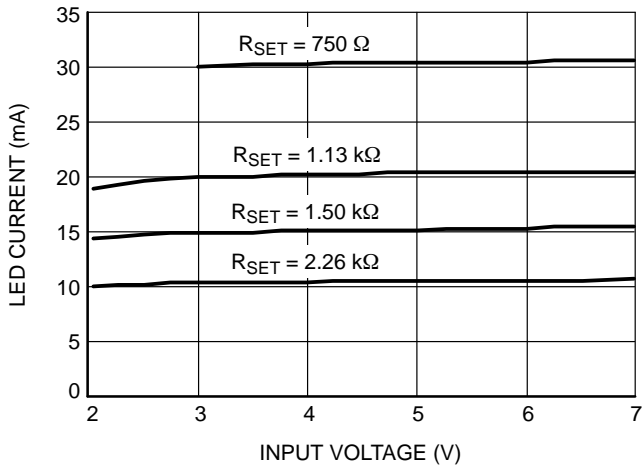

Figure 6. LED Current vs. Input Voltage

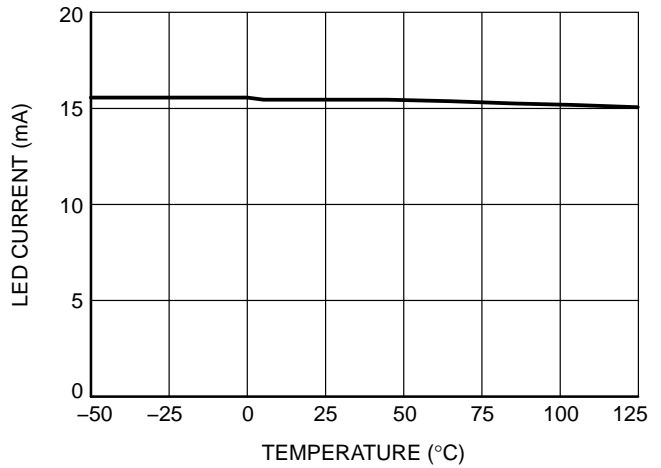

Figure 7. LED Current vs. Temperature

# CAT32

## TYPICAL CHARACTERISTICS

( $V_{IN} = 3.6\text{ V}$ ,  $T_{AMB} = 25^\circ\text{C}$ ,  $C_{IN} = 4.7\ \mu\text{F}$ ,  $C_{OUT} = 1\ \mu\text{F}$ ,  $L = 6.8\ \mu\text{H}$ , unless otherwise specified.)

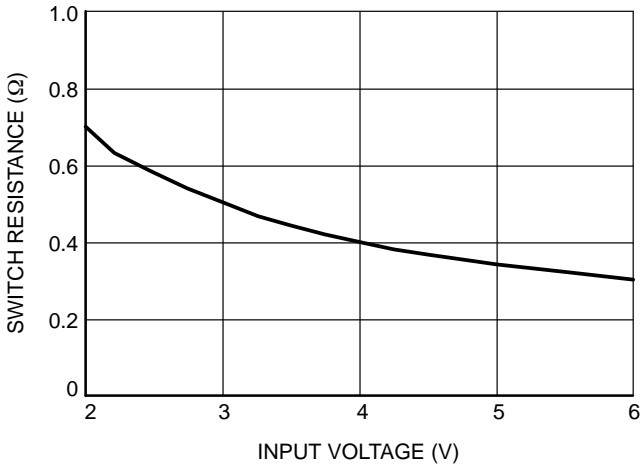

Figure 8. Switch Resistance vs. Input Voltage

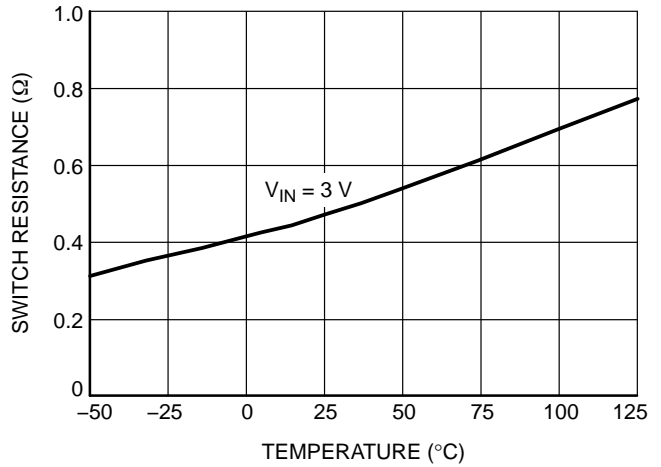

Figure 9. Switch Resistance vs. Temperature

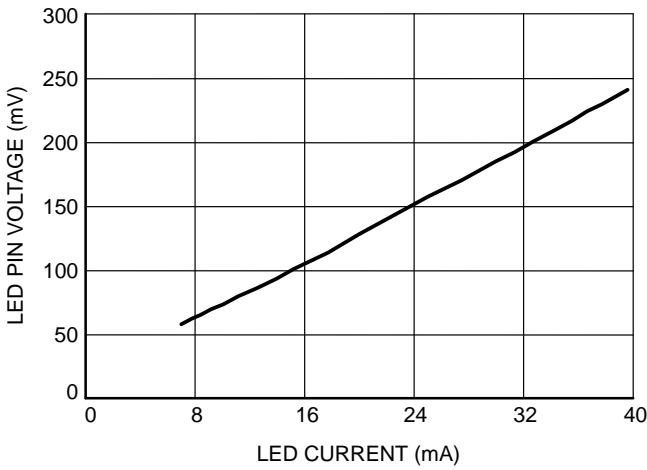
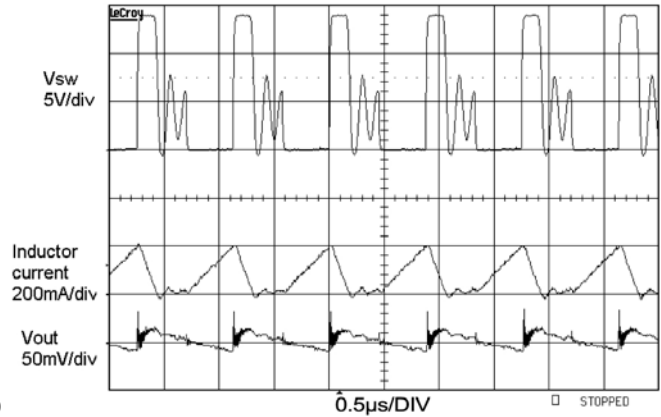

Figure 10. LED Pin Voltage vs. LED Current



$V_{IN} = 3.7\text{ V}$  with 15mA load through 4 LEDs

Figure 11.  $V_{SW}$ ,  $I_L$ , &  $V_{OUT}$  Signal Waveforms

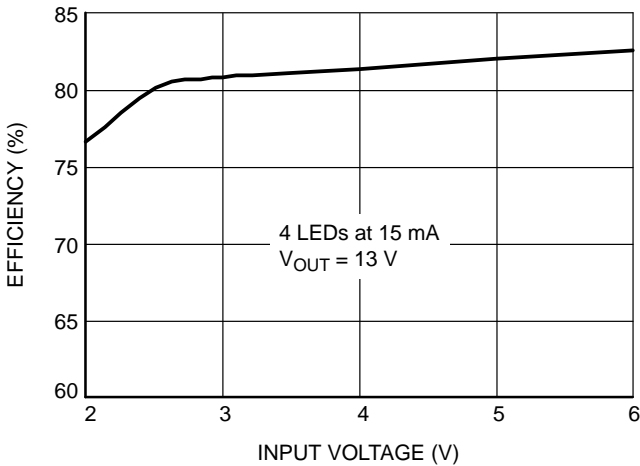

Figure 12. Efficiency vs. Input Voltage

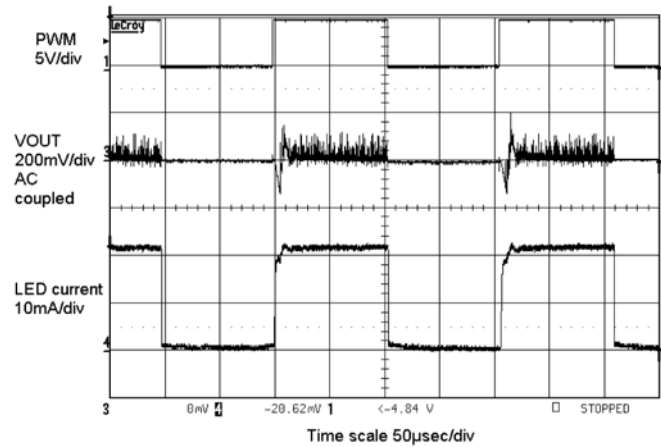

Figure 13. PWM on  $\overline{\text{SHDN}}$  Pin Waveform



**Application Information**  
**Inductor Selection and Efficiency**

Inductor vendors are shown below. Contact the manufacturer for detailed technical data and new product information.

**Table 5. INDUCTOR MANUFACTURERS**

Inductor	L (μH)	Maximum DCR (mΩ)	Maximum Height (mm)	Vendor	Web
ELJEA4R7	4.7	180	2.2	Panasonic 714.373.7334	www.panasonic.com
ELJEA6R8	6.8	250	2.2		
LQH3C4R7M24, LQH32CN4R7M11	4.7	260	2.2	Murata 770.436.1300	www.murata.com
LQH3C100K24, LQH32CN100K11	10	300	2.2		
LB2016B4R7	4.7	250	2.0	Taiyo Yuden 408.573.4150	www.t-yuden.com
LB2016B100	3.8	350	2.0		
CMD4D06-4R7	4.7	216	0.8	Sumida 847.956.0666	www.sumida.com
CMD4D06-6R8	6.8	296	0.8		
CLQ4D10-4R7	4.7	162	1.2		
CLQ4D10-6R8	6.8	195	1.2		

**Capacitor Selection**

Low ESR (equivalent series resistance) capacitors should be used at the output to minimize the output ripple voltage. The low ESR and small package options available with multilayer ceramic capacitors make them excellent choices. The X5R and X7R capacitor types are preferred because they retain their capacitance over wider voltage and temperature ranges than the Y5V or Z5U types. A 1.0 μF or 2.2 μF output capacitor is recommended for most applications.

The voltage rating of the output capacitor C2 depends on the number of LEDs driven in series. A 10 V ceramic capacitor is recommended when driving two LEDs. A 16 V ceramic capacitor is recommended when driving 3 or 4 LEDs.

**Table 6. CERAMIC CAPACITOR MANUFACTURERS**

Supplier	Phone	Web
Taiyo Yuden	408.573.4150	www.t-yuden.com
Murata	814.237.1431	www.murata.com
Kemet	408.986.0424	www.kemet.com

Low profile ceramic capacitors with a 1 mm maximum height/thickness are available for designs height requirements. Ceramic capacitors also make a good choice for the input capacitor, which should be mounted as close as possible to the CAT32. A 2.2 μF or 4.7 μF input capacitor is recommended. Table 6 shows a list of several ceramic capacitor manufacturers. Consult the manufacturers for detailed information as new products and package options are introduced regularly.

**Diode Selection**

Schottky diodes, with their low forward voltage drop and fast switching speed, are the ideal choice for high efficiency applications. Table 7 shows several different Schottky diodes that work well with the CAT32. Make sure that the diode has a voltage rating greater than the output voltage. The diode conducts current only when the power switch is turned off (typically less than one-third the time), so a 0.4 A or 0.5 A diode will be sufficient for most designs.

**Table 7. SCHOTTKY DIODE SUPPLIERS**

Part	Supplier
MBR0520	ON Semiconductor www.onsemi.com 800.282.9855
MBR0530 s	
MBR0540	
ZHCS400	Zetex

**LED Current Programming**

The LED current is programmed with a single resistor connected to the RSET pin. The RSET pin is internally regulated to 100 mV, which sets the current flowing out of this pin, ISET, equal to 100 mV/RSET. The CAT32 regulates the current into the LED pin, ILED, to 225 times the value of ISET. For the best accuracy, a 1% or better resistor is recommended. Table 8 shows several typical 1% RSET values.

Table 8. R<sub>SET</sub> RESISTOR VALUES

I <sub>LED</sub> (mA)	R <sub>SET</sub>
40	562 Ω
30	750 Ω
25	909 Ω
20	1.13 kΩ
15	1.50 kΩ
10	2.26 kΩ
5	4.53 kΩ

For other LED current values, use the following equation to choose R<sub>SET</sub>:

$$R_{SET} = 255 \times \frac{0.1 \text{ V}}{I_{LED}}$$

Most white LEDs are driven at maximum currents of 15 mA to 20 mA. Some higher power designs will use two parallel strings of LEDs for greater light output, resulting in 30 mA to 40 mA (two strings of 15 mA to 20 mA) flowing into the LED pin.

**LED Dimming with PWM Signal**

PWM brightness control provides the widest dimming range (greater than 20:1). By turning the LEDs ON and OFF using the control signal the LEDs operate at either zero or full current, but their average current changes with the PWM signal duty cycle. Typically, a 5 kHz to 40 kHz PWM signal is used. PWM dimming with the CAT32 can be accomplished two different ways.

The SHDN pin can be driven directly or a resistor can be added to drive the RSET pin. If the SHDN pin is used, increasing the duty cycle will increase the LED brightness. Using this method, the LEDs can be dimmed and turned off completely using the same control signal. A 0% duty cycle signal will turn off the CAT32, reducing the total quiescent current to near zero.

If the RSET pin is used, increasing the duty cycle will decrease the brightness. Using this method, the LEDs are dimmed using RSET and turned off completely using SHDN. If the RSET pin is used to provide PWM dimming, the approximate value of R<sub>PWM</sub> should be calculated (where V<sub>MAX</sub> is the “HIGH” value of the PWM signal):

$$R_{PWM} = R_{SET} \times \left( \frac{V_{MAX}}{0.15 \text{ V}} - 1 \right)$$

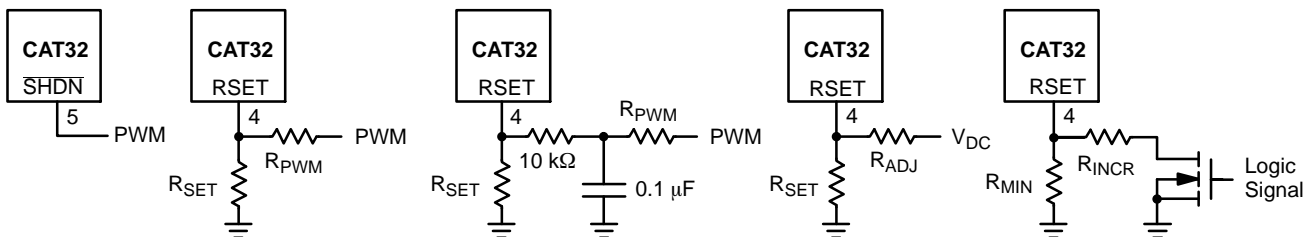

Figure 15. LED Dimming Circuits

In addition to providing the widest dimming range, PWM brightness control also ensures the “purest” white LED color over the entire dimming range. The true color of a white LED changes with operating current, and is the “purest” white at a specific forward current, usually 15 mA or 20 mA. If the LED current is less than or more than this value, the emitted light becomes more blue. Applications involving color LCDs can find the blue tint objectionable.

When a PWM control signal is used to drive the SHDN pin of the CAT32, the LEDs are turned off and on at the PWM frequency. The current through them alternates between full current and zero current, so the average current changes with duty cycle. This ensures that when the LEDs are on, they can be driven at the appropriate current to give the purest white light. LED brightness varies linearly with the PWM duty cycle.

**LED Dimming with a Logic Signal**

For applications that need to adjust the LED brightness in discrete steps, a logic signal can be used. R<sub>MIN</sub> sets the minimum LED current value (when the NMOS is OFF):

$$R_{MIN} = 255 \times \frac{0.1 \text{ V}}{I_{LED(MIN)}}$$

R<sub>INCR</sub> determines how much LED current increases when the external NMOS switch is turned ON.

$$R_{INCR} = 255 \times \frac{0.1 \text{ V}}{I_{LED(Increase)}}$$

**LED Dimming with a DC Voltage**

$$R_{ADJ} = 225 \times \frac{V_{MAX} - 0.1 \text{ V}}{I_{LED(MAX)} - I_{LED(MIN)}}$$

**PCB Layout Guidelines**

The CAT32 is a high-frequency switching regulator and therefore proper PCB board layout and component placement can minimize noise and radiation and increase efficiency. To maximize efficiency, the CAT32 design has fast switch rise and fall times. To prevent radiation and high frequency resonance problems minimize the length and area of all traces connected to the SW pin and use a ground plane under the switching regulator.

The switch, schottky output diode and output capacitor signal path should be kept as short as possible. The ground connection for the R<sub>SET</sub> resistor should be tied directly to the GND pin and not be shared with other components.

# CAT32

## TYPICAL APPLICATION CIRCUITS

(The application diagrams below are shown for the TSOT-23 packages.)

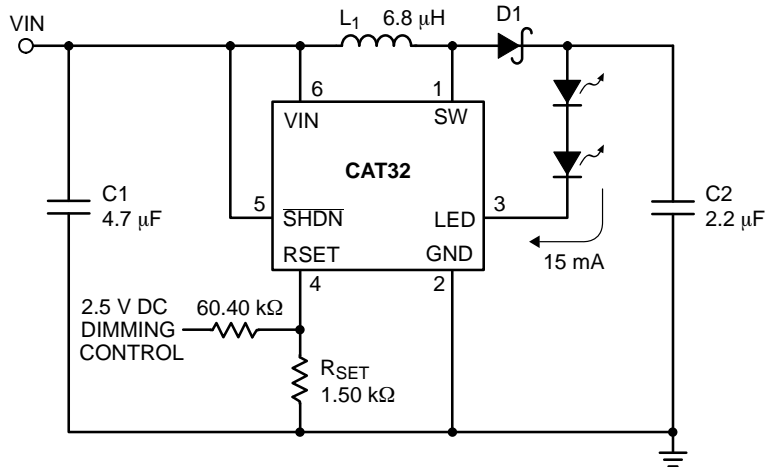

Figure 16. Two LEDs with DC Level Dimming Control

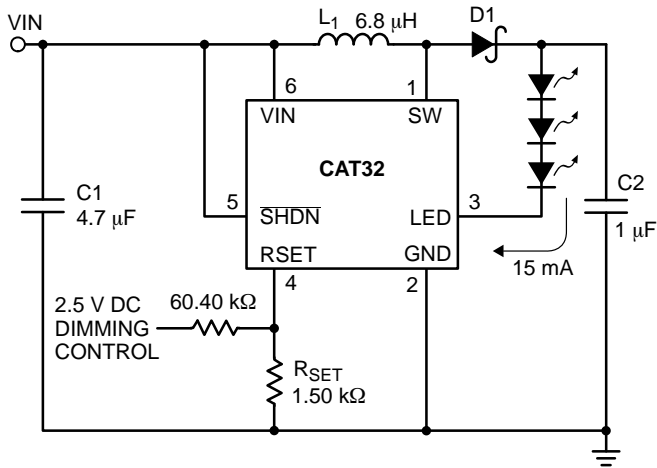

Figure 17. Three LEDs with DC Level Dimming Control

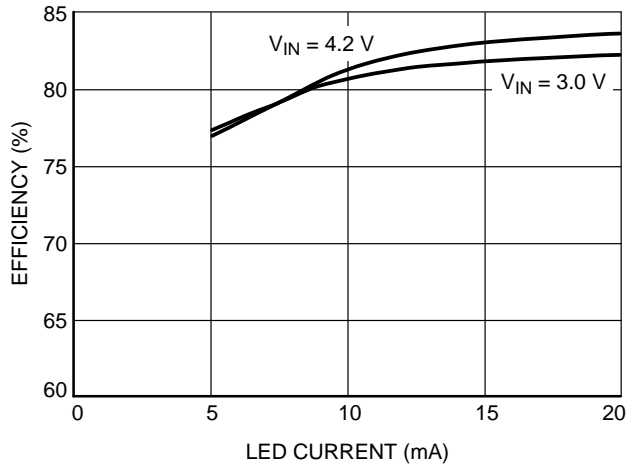

Figure 18. Efficiency - Three LEDs

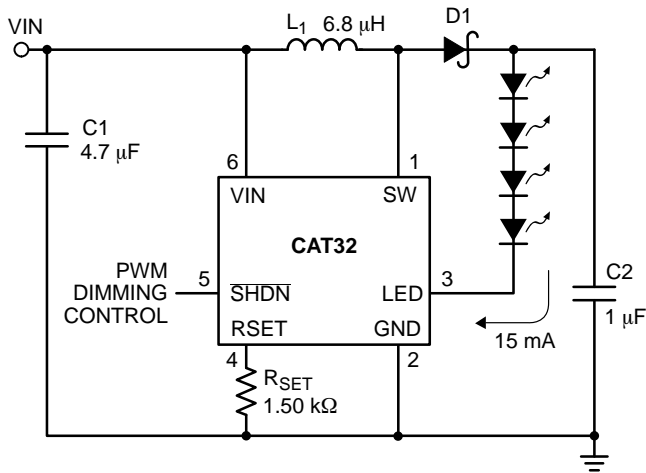

Figure 19. Four LEDs with PWM Dimming Control

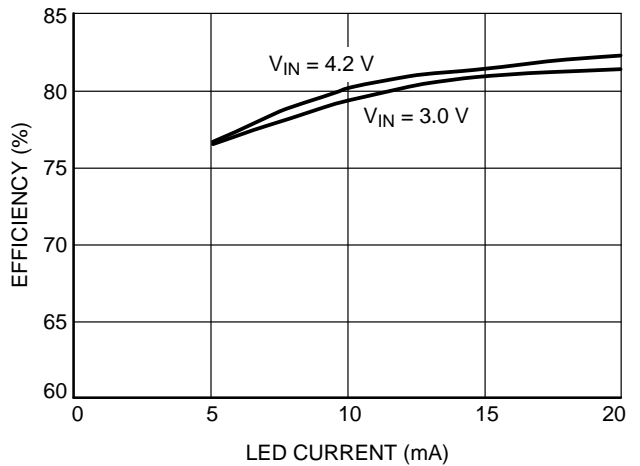
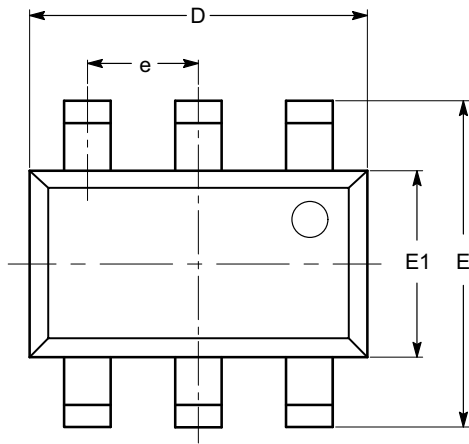

Figure 20. Efficiency - Four LEDs

# CAT32

## PACKAGE DIMENSIONS

TSOT-23, 6 LEAD  
CASE 419AF-01  
ISSUE O



TOP VIEW

SYMBOL	MIN	NOM	MAX
A			1.00
A1	0.01	0.05	0.10
A2	0.80	0.87	0.90
b	0.30		0.45
c	0.12	0.15	0.20
D	2.90 BSC		
E	2.80 BSC		
E1	1.60 BSC		
e	0.95 TYP		
L	0.30	0.40	0.50
L1	0.60 REF		
L2	0.25 BSC		
$\theta$	0°		8°

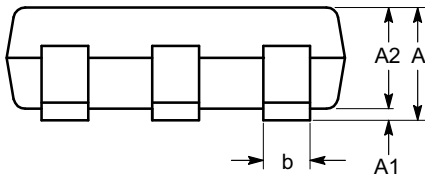

SIDE VIEW

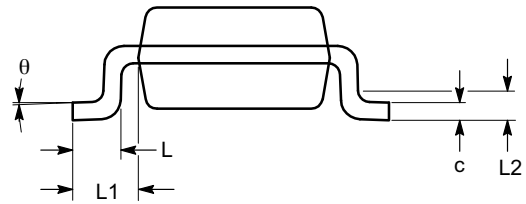

END VIEW

**Notes:**

- (1) All dimensions are in millimeters. Angles in degrees.
- (2) Complies with JEDEC MO-193.

# CAT32

1. All packages are RoHS-compliant (Lead-free, Halogen-free).
2. The standard lead finish is NiPdAu.
3. The device used in the above example is a CAT32TDI-GT3 (TSOT-23, Industrial Temperature Range, NiPdAu, Tape & Reel, 3,000 / Reel).
4. For additional package and temperature options, please contact your nearest ON Semiconductor Sales office.
5. For information on tape and reel specifications, including part orientation and tape sizes, please refer to our Tape and Reel Packaging Specifications Brochure, BRD8011/D.

ON Semiconductor and  are registered trademarks of Semiconductor Components Industries, LLC (SCILLC). SCILLC owns the rights to a number of patents, trademarks, copyrights, trade secrets, and other intellectual property. A listing of SCILLC's product/patent coverage may be accessed at [www.onsemi.com/site/pdf/Patent-Marking.pdf](http://www.onsemi.com/site/pdf/Patent-Marking.pdf). SCILLC reserves the right to make changes without further notice to any products herein. SCILLC makes no warranty, representation or guarantee regarding the suitability of its products for any particular purpose, nor does SCILLC assume any liability arising out of the application or use of any product or circuit, and specifically disclaims any and all liability, including without limitation special, consequential or incidental damages. "Typical" parameters which may be provided in SCILLC data sheets and/or specifications can and do vary in different applications and actual performance may vary over time. All operating parameters, including "Typicals" must be validated for each customer application by customer's technical experts. SCILLC does not convey any license under its patent rights nor the rights of others. SCILLC products are not designed, intended, or authorized for use as components in systems intended for surgical implant into the body, or other applications intended to support or sustain life, or for any other application in which the failure of the SCILLC product could create a situation where personal injury or death may occur. Should Buyer purchase or use SCILLC products for any such unintended or unauthorized application, Buyer shall indemnify and hold SCILLC and its officers, employees, subsidiaries, affiliates, and distributors harmless against all claims, costs, damages, and expenses, and reasonable attorney fees arising out of, directly or indirectly, any claim of personal injury or death associated with such unintended or unauthorized use, even if such claim alleges that SCILLC was negligent regarding the design or manufacture of the part. SCILLC is an Equal Opportunity/Affirmative Action Employer. This literature is subject to all applicable copyright laws and is not for resale in any manner.

## PUBLICATION ORDERING INFORMATION

### LITERATURE FULFILLMENT:

Literature Distribution Center for ON Semiconductor  
P.O. Box 5163, Denver, Colorado 80217 USA  
**Phone:** 303-675-2175 or 800-344-3860 Toll Free USA/Canada  
**Fax:** 303-675-2176 or 800-344-3867 Toll Free USA/Canada  
**Email:** [orderlit@onsemi.com](mailto:orderlit@onsemi.com)

**N. American Technical Support:** 800-282-9855 Toll Free  
USA/Canada  
**Europe, Middle East and Africa Technical Support:**  
Phone: 421 33 790 2910  
**Japan Customer Focus Center**  
Phone: 81-3-5817-1050



**ON Semiconductor Website:** [www.onsemi.com](http://www.onsemi.com)

**Order Literature:** <http://www.onsemi.com/orderlit>

For additional information, please contact your local Sales Representative

## Looking for pricing, stock, or lifecycle information?

Click below to explore more details on WIN SOURCE:

-  [View CAT32TDI-GT3 on WIN SOURCE](#)
-  [ON Semiconductor](#) Information

## Optimize Your Supply Chain with WIN SOURCE Solutions

-  Global Sourcing Solution
-  Obsolete Management
-  Cost Control Management
-  Shortage Management
-  Alternative Solution
-  Excess Inventory Management