



**THE DATASHEET OF
BML1ASK24W**



Amphenol Pcd

Connecting People & Technology

AlumaLight



Backshells

Within Amphenol's wide range of interconnect products is a full range of backshell hardware. Customers can take advantage of Amphenol's global synergy for connectors, backshells and cable harnessing in one place for all their interconnect needs. Plus, coming to Amphenol for a custom design of a backshell means that customers benefit from the vast amount of experience this global company has in designing interconnect solutions.

Amphenol Pcd

Connecting People & Technology

INTRODUCTION

AlumaLight Overview 5

ENVIRONMENTAL 6

BAND LOCK EMI/RFI 7

STRAIN RELIEF EMI/RFI 8

TEST REPORTS

Vibration Test Graphs Day 1 9

Vibration Test Graphs Day 2 10

Shock Test Reports 11

OTHER PRODUCTS

Backshell Families 12

Amphenol Pcd Products 13

An unmatched combination of weight, performance, and price

- Exceeds performance & functionality of MIL-standards
- More durable than composites
- Competitive pricing to composites
- Almost 50% weight savings from standard designs
- Equals composite in weight
- Far superior EMI performance than composite
- High shear strength - no breakage of coupling nuts

Three Product Line Families

- Environmental
- Band Lock EMI/RFI
- Strain Relief EMI/RFI



Environmental



Band Lock EMI/RFI



Strain Relief EMI/RFI

	Metal	Composites	AlumaLight
Mil-Standards & Performance	X	X	X
Strength & Durability	X		X
Reliability	X		X
Lightweight		X	X
EMI Shielding	X		X
Environmental	X		X
Strain Relief	X	X	X

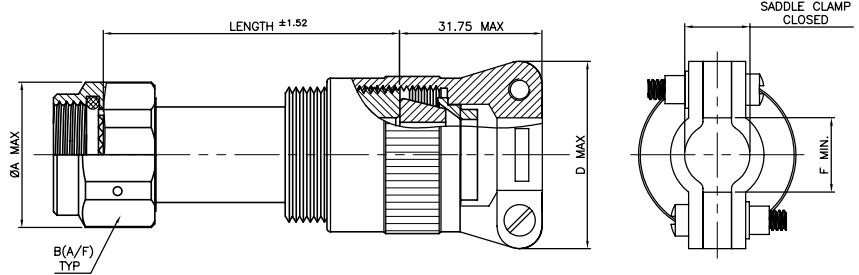

Amphenol Part Number								
BEL1	S	S	L	10	03	3	C	W
Basic Part #	Angle	Coupling	Connector Group	Shell Size (Table I)	Entry Size (Table I)	Standard Length & Figure	C: Clamp N: Nut	Material & Finish (Table III)
	S: Straight	S: Self Lock	K: MIL-DTL-38999 Series I & II L: MIL-DTL-38999 Series III & IV					

Shell Size	Length Code	ØA MAX.	B HEX	MAX. Entry Size
8	1	20.40	16.99/17.42	02
	2			
10	1	21.79	18.69/19.05	03
	2			
12	1	24.99	21.84/22.23	04
	2			
14	1	29.39	24.89/25.40	05
	2			
	3			
16	1	32.51	28.58/27.94	06
	2			
	3			
18	1	35.71	31.09/31.75	07
	2			
	3			
20	1	38.51	34.24/34.93	07
	2			
	3			
22	1	41.51	37.31/38.20	08
	2			
	3			
24	1	44.91	40.16/41.28	10
	2			
	3			

Entry Size	Cable Range		Saddle Clamp Closed ± 0.78	D MAX.	F MIN.
	Inch	mm			
02	3.18	6.35	6.70	23.90	6.90
03	6.35	9.53	8.70	28.40	9.53
04	7.92	12.70	11.70	30.20	12.70
05	11.1	15.88	15.70	39.60	15.88
06	14.27	19.05	17.70	42.90	19.05
07	17.45	22.23	19.80	44.50	22.23
08	20.62	25.40	21.60	47.80	25.40
09	23.80	28.58	25.30	63.50	28.58
10	26.97	31.75	31.00	68.10	31.75

Finish Code	Material & Finish
W	Aluminum Alloy, Cadmium Olive Drab
N	Aluminum Alloy/ Electroless Nickel
For More Finish Refer PSTDBS256	

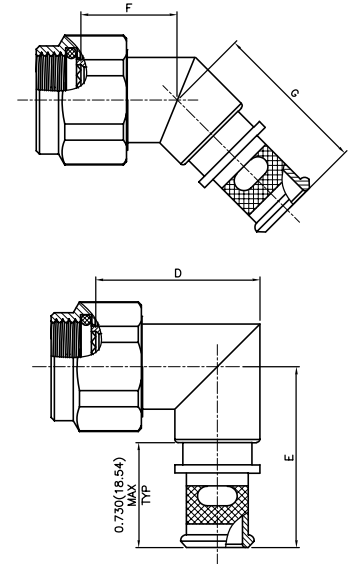
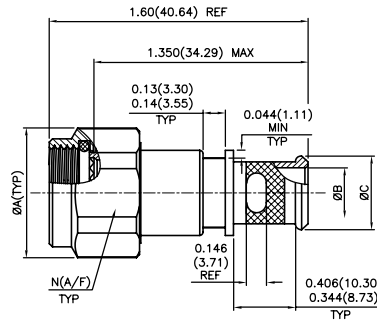

Amphenol Part Number										
BLL1	S	S	L		10	03	9	X	W	S
Basic Part #	Angle	Coupling	Connector Group		Shell Size (Table I)	Entry Size (Table I)	Standard Length & Figure	B:W/ Band X: W/O Band	Material & Finish Code (Table II)	Slot (Omit for none)
	S: Straight A: 90 B: 45	S: Self Lock	K: MIL-DTL-38999 Series I & II L: MIL-DTL-38999 Series III & IV							

Shell Size	ØA MAX.		N HEX		B				C REF.				D MAX.	
	Inch	mm	Inch	mm	02		03		02		03		Inch	mm
					Inch	mm	Inch	mm	Inch	mm	Inch	mm		
8	0.803	20.40	0.668/ 0/686	16.99/17.42	-	-	0.250	6.40	--	--	0.395	10.0	1.375	34.93
10	0.858	21.79	0.736/ 0.750	18.69/ 19.05	-	-	0.312	7.90	--	--	0.457	11.60	1.437	36.50
12	0.984	24.99	0.860/ 0.875	21.84/ 22.23	0.312	7.90	0.438	11.10	0.457	11.60	0.583	14.80	1.562	39.67
14	1.157	29.39	0.980/ 1.000	24.89/ 25.40	0.438	11.10	0.562	14.30	0.583	14.80	0.707	18.00	1.687	42.85
16	1.280	32.51	1.100/ 1.125	25.58/ 27.94	0.500	12.70	0.625	15.90	0.645	16.40	0.770	19.60	1.750	44.45
18	1.406	35.71	1.224/ 1.250	31.09/ 31.75	0.625	15.90	0.750	19.10	0.770	19.60	0.895	22.70	1.875	47.63
20	1.516	38.51	1.348/ 1.375	34.24/ 34.93	0.625	15.90	0.812	20.60	0.770	19.60	0.957	24.30	1.938	49.23
22	1.642	41.51	1.469/ 1.500	37.31/ 38.10	0.688	17.50	0.938	23.80	0.829	21.10	1.083	27.50	2.062	52.37
24	1.768	44.91	1.581/ 1.625	40.16/ 41.28	0.750	19.10	1.000	25.40	0.895	22.70	1.145	29.10	2.125	53.98

E MAX.		F MAX.		G MAX.		S (No of Slots)	
Inch	mm	Inch	mm	Inch	mm	Inch	mm
1.417	35.90	1.01	25.07	1.16	29.50	0.170	4.31
1.480	37.59	1.03	26.20	1.19	30.20	0.170	4.31
1.553	39.45	1.06	26.90	1.21	30.70	0.170	4.31
1.614	41.00	1.08	27.40	1.24	31.50	0.250	6.35
1.678	42.62	1.11	28.20	1.26	32.00	0.250	6.35
1.773	45.03	1.12	28.40	1.27	32.30	0.500	12.70
1.796	45.62	1.15	29.20	1.30	33.00	0.500	12.70
1.859	47.22	1.17	29.70	1.33	33.80	0.500	12.70
1.919	48.74	1.20	30.50	1.35	34.30	0.500	12.70

Finish Code	Material & Finish
W	Aluminum Alloy, Cadmium Olive Drab
N	Aluminum Alloy/ Electroless Nickel
For More Finish Refer PSTDBS256	

STRAIN RELIEF EMI/RFI

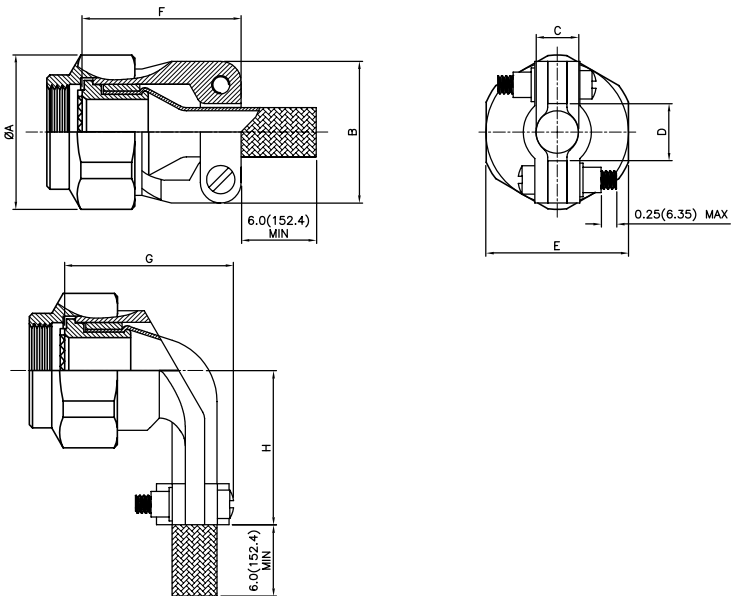
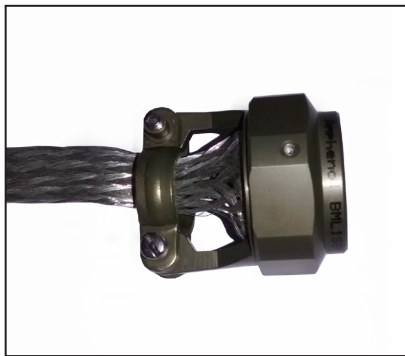

Amphenol Part Number					
BML1	S	S	K	10	W
Basic Part #	Angle	Coupling	Connector Group	Shell Size (Table I)	Material & Finish (Table II)
	S: Straight A: 90	S: Self Lock	K: MIL-DTL-38999 Series I & II L: MIL-DTL-38999 Series III & IV		

Table I

Size Number	ØA MAX.		B MAX.		C		D MIN.		E HEX		F		G MAX.		H MAX.	
	Inch	mm	Inch	mm	0.031	0.78	Inch	mm	Inch	mm	Inch	mm	Inch	mm	Inch	mm
					Inch	mm										
8	0.858	21.79	0.880	22.40	0.219	5.60	0.220	5.60	0.750/0.736	19.05/18.69	0.780/0.939	19.81/23.85	1.128	28.65	0.940	23.88
10	0.984	24.99	0.940	23.90	0.264	6.70	0.270	6.90	0.875/0.860	22.23/21.84	0.860/1.059	21.84/26.90	1.168	29.67	1.000	25.40
12	1.157	29.39	1.120	28.40	0.344	8.70	0.350	8.90	1.000/0.980	25.40/24.89	0.950/1.199	24.10/30.45	1.248	31.70	1.120	27.69
14	1.280	32.51	1.190	30.20	0.435	11.05	0.470	11.90	1.125/1.100	28.58/27.94	0.950/1.199	24.13/30.45	1.368	34.75	1.190	30.23
16	1.406	35.71	1.440	36.60	0.540	13.72	0.550	14.00	1.250/1.224	31.75/31.09	1.080/1.329	27.43/33.75	1.448	36.78	1.370	34.89
18	1.516	38.51	1.560	39.60	0.620	15.75	0.620	15.70	1.438/1.407	36.52/35.73	1.140/1.509	28.90/38.33	1.528	38.61	1.440	36.58
20	1.642	41.51	1.690	42.90	0.695	17.65	0.700	17.80	1.500/1.469	38.10/37.31	1.200/1.609	30.50/40.87	1.648	41.86	1.560	39.67
22	1.768	44.91	1.750	44.50	0.770	19.56	0.780	19.80	1.625/1.581	41.28/40.16	1.330/1.759	33.80/44.68	1.688	42.88	1.690	42.85
24	1.890	48.01	1.880	47.80	0.820	20.83	0.850	21.60	1.750/1.690	44.45/42.93	1.450/1.859	36.80/47.22	1.758	44.65	1.810	46.02

Finish Code	Material & Finish
W	Aluminum Alloy, Cadmium Olive Drab
N	Aluminum Alloy/ Electroless Nickel

For More Finish Refer PSTDBS256

VIBRATION TEST GRAPHS

DUT: Backshell

Serial Number: BML1SSK10W (3nos) OX Axis

Project File Name: Random vibration 43.92grms.prj

Profile Name: Default

Test Type: Random

Run Folder: \RunFolder Apr 01, 2015 13-43-56

Level: 100 %

Control RMS: 44.258648 gn

Full Level Elapsed Time: 08:00:00

Lines: 400 Frame Time: 0.200000 Seconds

Demand RMS: 43.941341 gn

Remaining Time:00:00:00

DOF: 154 dF:5.000000 Hz

Data saved at 09:54:53 PM, Wednesday, April 01, 2015 Report created at 09:54:54 PM Wednesday, April 1, 2015

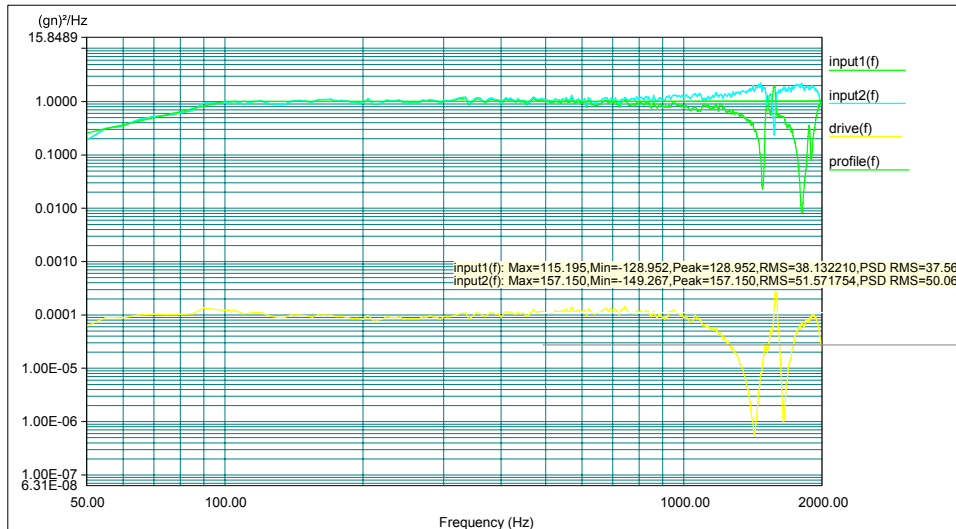
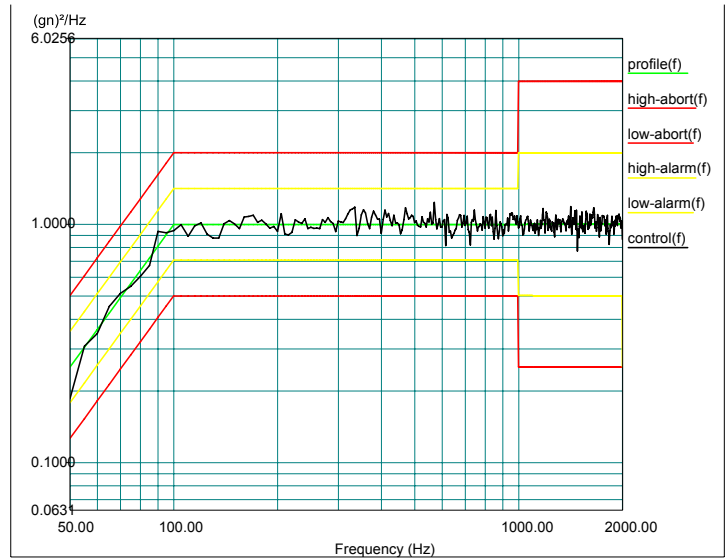

Screenshot of the Shaker Control software interface. The main window displays a composite of PSD graphs for profile, high-abort, low-abort, high-alarm, low-alarm, and control. The y-axis is (gn)²/Hz and the x-axis is Frequency (Hz). The interface includes a control panel on the right with buttons for Start, Stop, and Run. A status window at the bottom left shows channel status and a table of channel data.

Chan#	Clipped	Units	Min	Max
1	No	gn	0.103	0.1
2	No	gn	0.123	0.1

VIBRATION TEST GRAPHS

DUT: Backshell

Serial Number: BML1SSK10W (3nos) OY Axis

Project File Name: Random vibration 43.92gms.prj

Profile Name: Default Test Type: \RunFolder Apr 02, 2015 09-29-13

Level: 100 %

Control RMS: 44.156834 gn

Full Level Elapsed Time: 08:00:00 Lines: 400 Frame Time: 0.200000 Seconds

Demand RMS: 43.941341 gn

Remaining Time:00:00:00

DOF: 154 dF:5.000000 Hz

Data saved at 06:57:43 PM, Thursday, April 02, 2015 Report created at 06:57:44 PM, Thursday, April 2, 2015

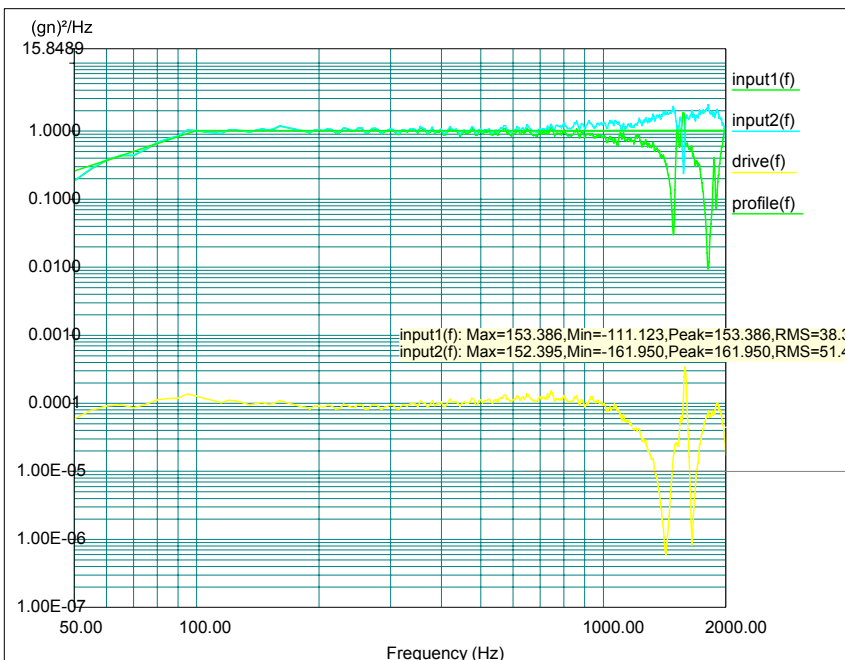
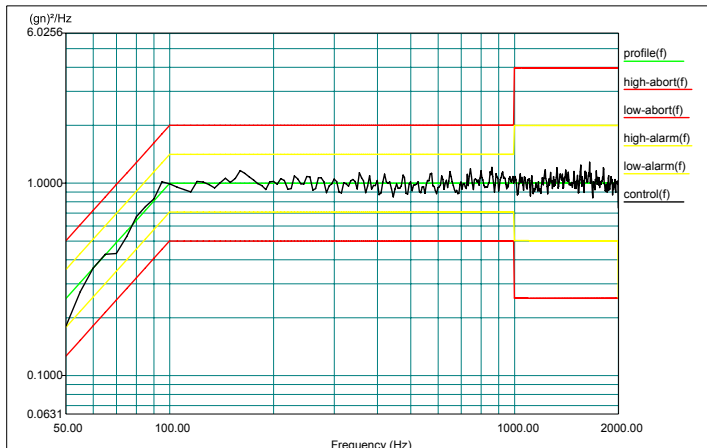

The screenshot shows the 'Shaker Control - Random Random vibration 43.92gms.prj' software interface. The main window displays the test profile and control signals. The y-axis is $(gn)^2/Hz$ and the x-axis is Frequency (Hz). The legend includes: profile(f), high-abort(f), low-abort(f), high-alarm(f), low-alarm(f), and control(f). The interface also shows various control parameters and a 'RANDOM' button.

Channel	Cropped	Clipped	# Limits	Max	Min	Peak	RMS	PSD RMS
1	No	No	gn	0.194	-0.122	0.122	0.034	0.255
2	No	No	gn	0.196	-0.165	0.166	0.044	0.340

SHOCK TEST REPORTS



VST Shock Tool Data File
 Sat 04-04-15 @ 09:55:13
 Sample rate(Hz): 100000
 plot scale assign
 Sensor Sensitivities (mV/LUNIT)
 0.9640
 Data (Volts)
 Duration (ms) 6.0

Notes
 Current Time 09:56:40
 04/04/2015
 BML1 SSK 10W Backshell 100g 6ms -X axis No of shocks 3 Nos

Selected Plot 1
 Peak (g) 99.083
 Delta T (ms) 6.906
 Delta V (In/s) 157.4
 1/2Delta T (Hz) 72.4
 LP Filter (Hz) 320.0

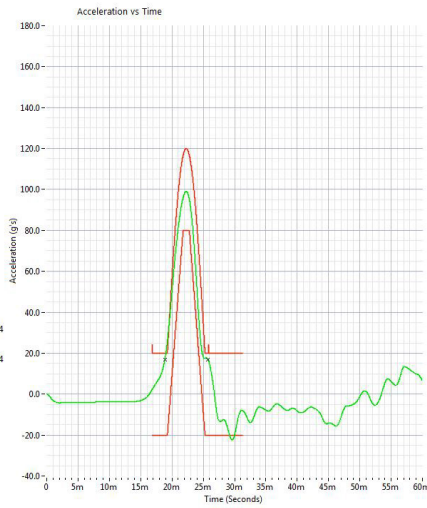

VST Shock Tool Data File
 Sat 04-04-15 @ 10:13:41
 Sample rate(Hz): 100000
 plot scale assign
 Sensor Sensitivities (mV/LUNIT)
 0.9640
 Data (Volts)
 Duration (ms) 6.0

Notes
 Current Time 10:13:57
 04/04/2015
 BML1 SSK 10W Backshell 100g 6ms -Y axis No of shocks 3 Nos

Selected Plot 1
 Peak (g) 105.316
 Delta T (ms) 6.829
 Delta V (In/s) 175.1
 1/2Delta T (Hz) 73.2
 LP Filter (Hz) 210.0

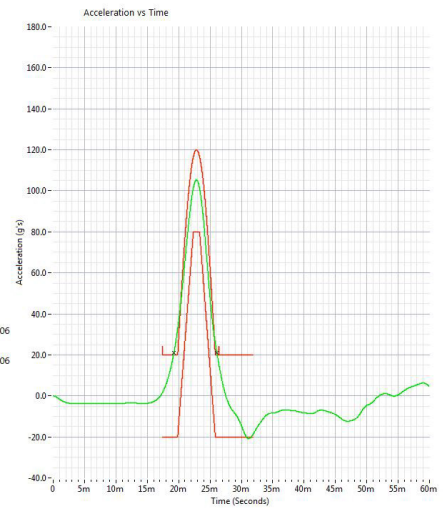

VST Shock Tool Data File
 Sat 04-04-15 @ 09:59:11
 Sample rate(Hz): 100000
 plot scale assign
 Sensor Sensitivities (mV/LUNIT)
 0.9640
 Data (Volts)
 Duration (ms) 6.0

Notes
 Current Time 09:59:30
 04/04/2015
 BML1 SSK 10W Backshell 100g 6ms -X axis No of shocks 3 Nos

Selected Plot 1
 Peak (g) 100.001
 Delta T (ms) 6.887
 Delta V (In/s) 165.0
 1/2Delta T (Hz) 72.6
 LP Filter (Hz) 210.0

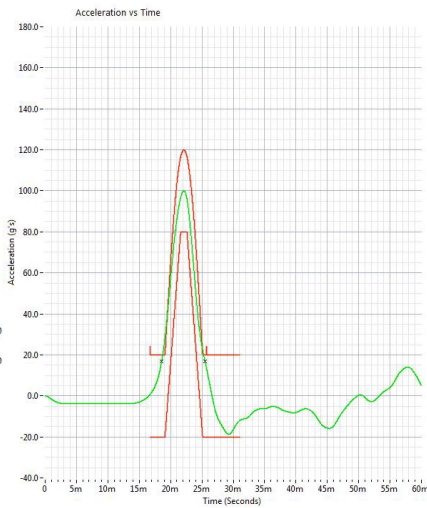

VST Shock Tool Data File
 Sat 04-04-15 @ 10:49:29
 Sample rate(Hz): 100000
 plot scale assign
 Sensor Sensitivities (mV/LUNIT)
 0.9640
 Data (Volts)
 Duration (ms) 6.0

Notes
 Current Time 10:50:00
 04/04/2015
 BML1 SSK 10W Backshell 100g 6ms -Z axis No of shocks 3 Nos

Selected Plot 1
 Peak (g) 104.914
 Delta T (ms) 6.536
 Delta V (In/s) 128.1
 1/2Delta T (Hz) 76.5
 LP Filter (Hz) 200.0

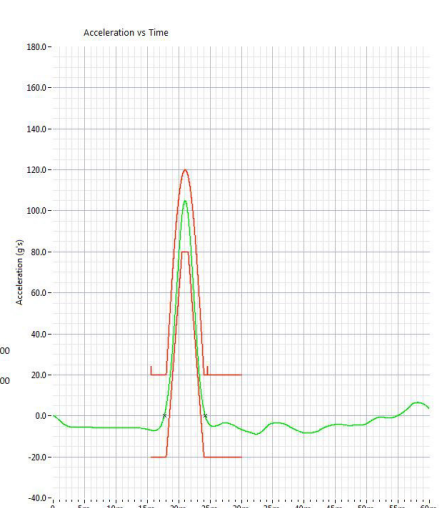

VST Shock Tool Data File
 Sat 04-04-15 @ 10:51:10
 Sample rate(Hz): 100000
 plot scale assign
 Sensor Sensitivities (mV/LUNIT)
 0.9640
 Data (Volts)
 Duration (ms) 6.0

Notes
 Current Time 10:51:21
 04/04/2015
 BML1 SSK 10W Backshell 100g 6ms -Y axis No of shocks 3 Nos

Selected Plot 1
 Peak (g) 103.701
 Delta T (ms) 6.539
 Delta V (In/s) 126.9
 1/2Delta T (Hz) 76.5
 LP Filter (Hz) 200.0

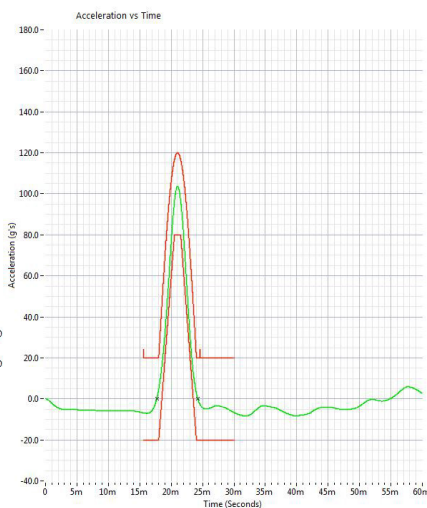

VST Shock Tool Data File
 Sat 04-04-15 @ 10:52:11
 Sample rate(Hz): 100000
 plot scale assign
 Sensor Sensitivities (mV/LUNIT)
 0.9640
 Data (Volts)
 Duration (ms) 6.0

Notes
 Current Time 10:52:33
 04/04/2015
 BML1 SSK 10W Backshell 100g 6ms -Z axis No of shocks 3 Nos

Selected Plot 1
 Peak (g) 103.273
 Delta T (ms) 6.587
 Delta V (In/s) 127.4
 1/2Delta T (Hz) 75.9
 LP Filter (Hz) 200.0

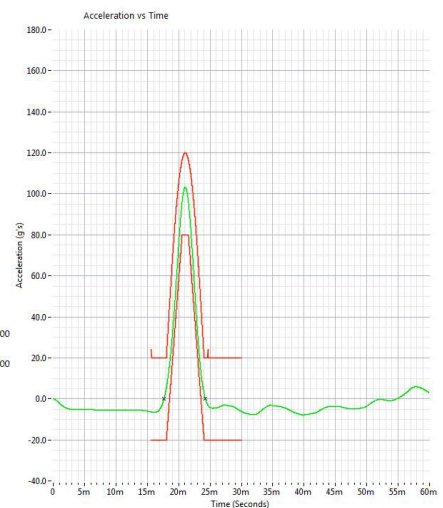

BACKSHELL FAMILIES

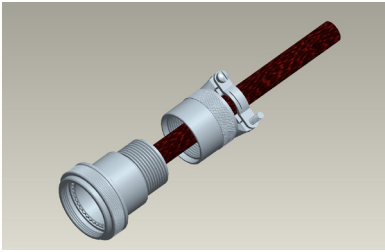

Non-Environmental Backshell

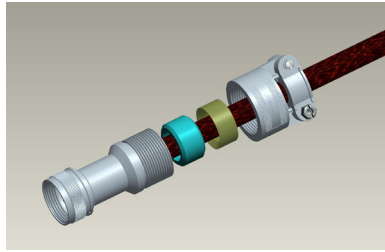

Environmental Backshell

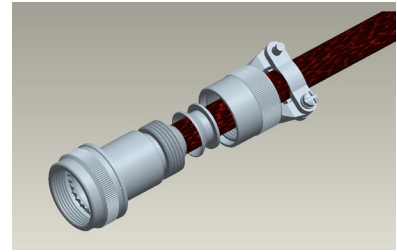

Non-Environmental EMI/RFI Backshell

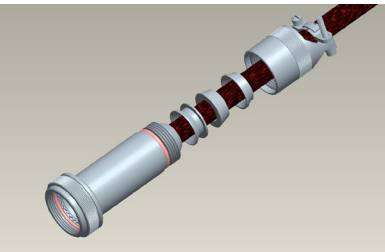

Environmental EMI/RFI Backshell

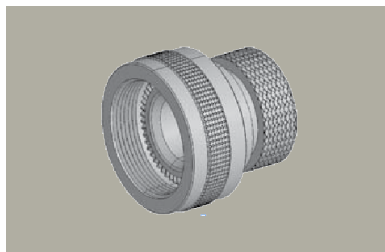

Shrink Boot Adapter

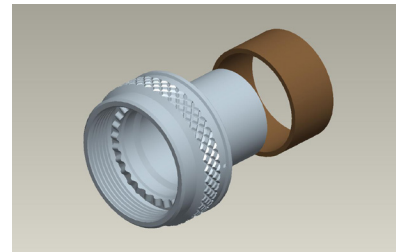

Crimp Ring Adapter

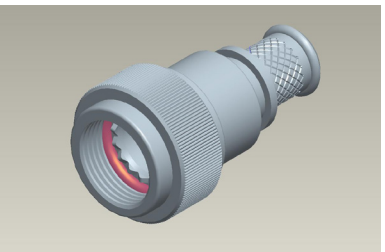

Band Lock Adapter

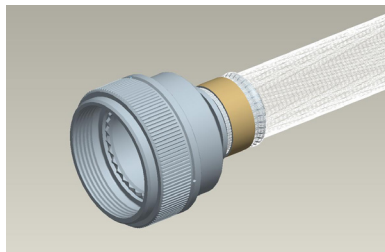

Pre-Shield Adapter



SQ Adapter

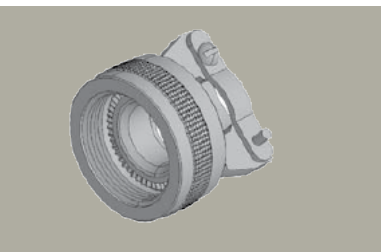

Strain Relief Clamps

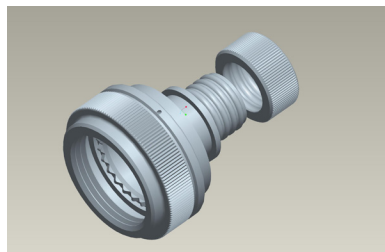

Lamp Thread Adapter

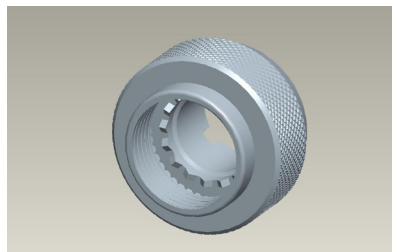

Grommet Nut

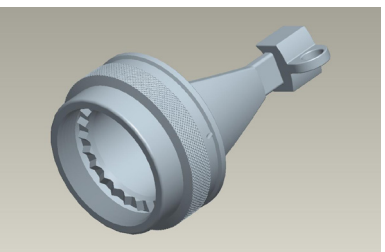

Quick Clamp

AMPHENOL PCD PRODUCTS



Backshells



Cable Solutions & Cable Adapters
NEW

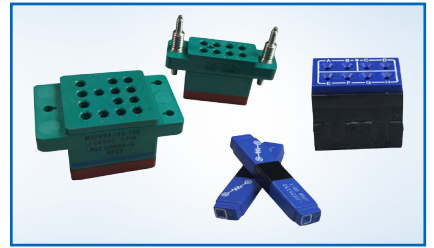

Relay Sockets & Junction Modules

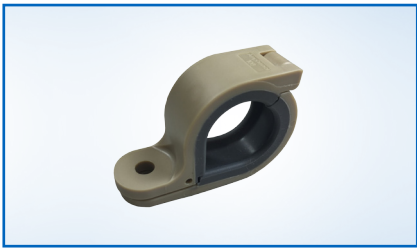

System Attachments



Luminus Series, & Pegasus Series

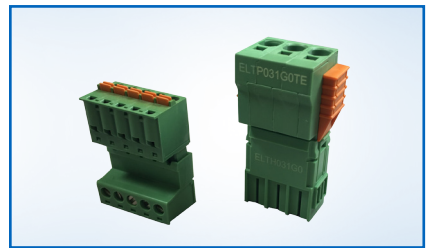

Terminal Blocks

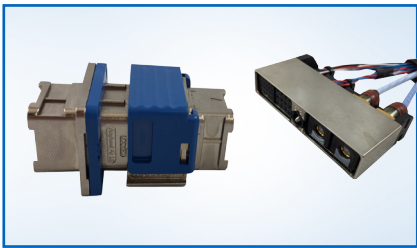

SIM



Rectangular



Circular



Waterproof Solutions



Rugged Ethernet & USB



Military Audio /Power

Amphenol Pcd

Amphenol Pcd, a subsidiary of Amphenol Corporation, is one of the world's leading suppliers of interconnect products for Military, Commercial Aerospace and Industrial applications. Located north of Boston in Beverly, Massachusetts, the company designs and manufactures a wide range of products - System Attachments, Junction Modules, Relay Sockets, Terminal Blocks, Rectangular & Circular connectors, and Cable Assemblies & Adapters.

Each product is made and engineered with the highest quality standards in the industry. With facilities in North America and Asia, Amphenol Pcd products are chosen by hundreds of OEMs around the world, reliant on Amphenol's technical excellence, global network of distributors, and cost-effective solutions for custom systems.

Amphenol Pcd

Connecting People & Technology

Notice: Specifications are subject to change without notice. Contact your nearest Amphenol Corporation Sales Office for the latest specifications. All statements, information and data given herein are believed to be accurate and reliable, but are presented without guarantee, warranty, or responsibility of any kind expressed or implied. Statements or suggestions concerning possible use of our products are made without representation or warranty that any such use is free of patent infringement and are not recommendations to infringe any patent. The user should not assume that all safety measures are indicated or that other measures may not be required. Specifications are typical and may not apply to all connectors.

© 2015 Amphenol Pcd

Amphenol Pcd

72 Cherry Hill Dr. Beverly, MA. 01915

info@amphenolpcd.com • (978) 624.3400



www.amphenolpcd.com

FOLLOW US



Looking for pricing, stock, or lifecycle information?

Click below to explore more details on WIN SOURCE:

-  [View BML1ASK24W on WIN SOURCE](#)
-  [Amphenol PCD Information](#)

Optimize Your Supply Chain with WIN SOURCE Solutions

-  Global Sourcing Solution
-  Obsolete Management
-  Cost Control Management
-  Shortage Management
-  Alternative Solution
-  Excess Inventory Management