



**THE DATASHEET OF
BZD17C39P-E3-08**



Zener Diodes

Features

- Silicon planar zener diodes
- Low profile surface-mount package
- Low leakage current
- Excellent stability
- High temperature soldering: 260 °C/10 s at terminals
- Compliant to RoHS directive 2002/95/EC and in accordance to WEEE 2002/96/EC



RoHS
COMPLIANT

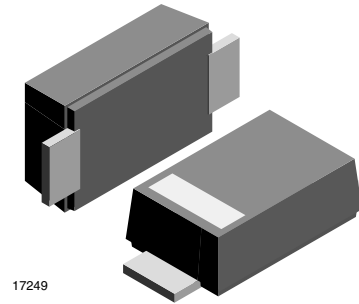

Mechanical Data

Case: JEDEC DO219AB (SMF[®]) plastic case

Weight: approx. 15 mg

Packaging codes/options:

GS18/10K per 13" reel, (8 mm tape), 50K/box

GS08/3K per 7" reel, (8 mm tape), 30K/box

Absolute Maximum Ratings

$T_{amb} = 25\text{ °C}$, unless otherwise specified

Parameter	Test condition	Symbol	Value	Unit
Power dissipation	$T_L = 80\text{ °C}$	P_{tot}	2.3	W
	$T_A = 25\text{ °C}$	P_{tot}	0.8 ¹⁾	W
Non-repetitive peak pulse power dissipation	100 μ s square pulse ²⁾	P_{ZSM}	300	W

Notes:

¹⁾ Mounted on epoxy-glass PCB with 3 mm x 3 mm Cu pads ($\geq 40\text{ }\mu\text{m}$ thick)

²⁾ $T_j = 25\text{ °C}$ prior to surge

Thermal Characteristics

$T_{amb} = 25\text{ °C}$, unless otherwise specified

Parameter	Test condition	Symbol	Value	Unit
Thermal resistance junction to ambient air ¹⁾		R_{thJA}	180	K/W
Thermal resistance junction to lead		R_{thJL}	30	K/W
Maximum junction temperature		T_j	150	°C
Storage temperature range		T_{stg}	- 55 to + 150	°C

Notes:

¹⁾ Mounted on epoxy-glass PCB with 3 mm x 3 mm Cu pads ($\geq 40\text{ }\mu\text{m}$ thick)

Electrical Characteristics

$T_{amb} = 25\text{ °C}$, unless otherwise specified

Parameter	Test condition	Symbol	Min.	Typ.	Max.	Unit
Forward voltage	$I_F = 0.2\text{ A}$	V_F			1.2	V

BZD17C3V6P to BZD17C200P



Vishay Semiconductors

Electrical Characteristics

$T_J = 25\text{ }^\circ\text{C}$, unless otherwise specified

Part number	Marking code	Working voltage ¹⁾		Differential resistance		Temperature coefficient		Test current	Reverse leakage current	
		V_Z at I_{ZT}		r_{dif} at I_Z		α_Z at I_Z		I_{ZT}	I_R	V_R
		V		Ω		%/°C		mA	μA	V
		min.	max.	typ.	max.	min.	max.		max.	
BZD17C3V6P	I0	3.4	3.8	4	8	-0.14	-0.04	100	100	1
BZD17C3V9P	I1	3.7	4.1	4	8	-0.14	-0.04	100	50	1
BZD17C4V3P	I2	4	4.6	4	7	-0.12	-0.02	100	25	1
BZD17C4V7P	I3	4.4	5	3	7	-0.1	0	100	10	1
BZD17C5V1P	I4	4.8	5.4	3	6	-0.08	0.02	100	5	1
BZD17C5V6P	I5	5.2	6	2	4	-0.04	0.04	100	10	2
BZD17C6V2P	I6	5.8	6.6	2	3	-0.01	0.06	100	5	2
BZD17C6V8P	I7	6.4	7.2	1	3	0	0.07	100	10	3
BZD17C7V5P	I8	7	7.9	1	2	0	0.07	100	50	3
BZD17C8V2P	I9	7.7	8.7	1	2	0.03	0.08	100	10	3
BZD17C9V1P	J0	8.5	9.6	2	4	0.03	0.08	50	10	5
BZD17C10P	J1	9.4	10.6	2	4	0.05	0.09	50	7	7.5
BZD17C11P	J2	10.4	11.6	4	7	0.05	0.1	50	4	8.2
BZD17C12P	J3	11.4	12.7	4	7	0.05	0.1	50	3	9.1
BZD17C13P	J4	12.4	14.1	5	10	0.05	0.1	50	2	10
BZD17C15P	J5	13.8	15.6	5	10	0.05	0.1	50	1	11
BZD17C16P	J6	15.3	17.1	6	15	0.06	0.11	25	1	12
BZD17C18P	J7	16.8	19.1	6	15	0.06	0.11	25	1	13
BZD17C20P	J8	18.8	21.2	6	15	0.06	0.11	25	1	15
BZD17C22P	J9	20.8	23.3	6	15	0.06	0.11	25	1	16
BZD17C24P	K0	22.8	25.6	7	15	0.06	0.11	25	1	18
BZD17C27P	K1	25.1	28.9	7	15	0.06	0.11	25	1	20
BZD17C30P	K2	28	32	8	15	0.06	0.11	25	1	22
BZD17C33P	K3	31	35	8	15	0.06	0.11	25	1	24
BZD17C36P	K4	34	38	21	40	0.06	0.11	10	1	27
BZD17C39P	K5	37	41	21	40	0.06	0.11	10	1	30
BZD17C43P	K6	40	46	24	45	0.07	0.12	10	1	33
BZD17C47P	K7	44	50	24	45	0.07	0.12	10	1	36
BZD17C51P	K8	48	54	25	60	0.07	0.12	10	1	39
BZD17C56P	K9	52	60	25	60	0.07	0.12	10	1	43
BZD17C62P	L0	58	66	25	80	0.08	0.13	10	1	47
BZD17C68P	L1	64	72	25	80	0.08	0.13	10	1	51
BZD17C75P	L2	70	79	30	100	0.08	0.13	10	1	56
BZD17C82P	L3	77	87	30	100	0.08	0.13	10	1	62
BZD17C91P	L4	85	96	60	200	0.08	0.13	5	1	68
BZD17C100P	L5	94	106	60	200	0.09	0.13	5	1	75
BZD17C110P	L6	104	116	80	250	0.09	0.13	5	1	82
BZD17C120P	L7	114	127	80	250	0.09	0.13	5	1	91
BZD17C130P	L8	124	141	110	300	0.09	0.13	5	1	100
BZD17C150P	L9	138	156	130	300	0.09	0.13	5	1	110
BZD17C160P	M0	153	171	150	350	0.09	0.13	5	1	120
BZD17C180P	M1	168	191	180	400	0.09	0.13	5	1	130
BZD17C200P	M2	188	212	200	500	0.09	0.13	5	1	150

Note:

¹⁾ Pulse test: $t_p \leq 5\text{ ms}$

Typical Characteristics

$T_{amb} = 25\text{ }^{\circ}\text{C}$, unless otherwise specified

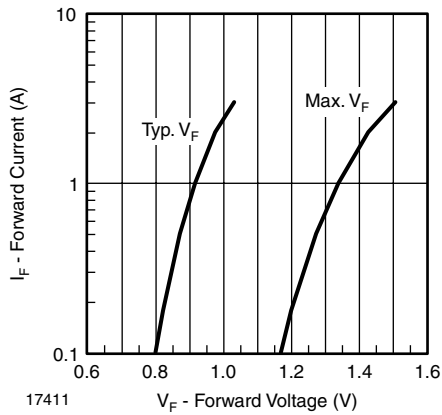

Figure 1. Forward Current vs. Forward Voltage

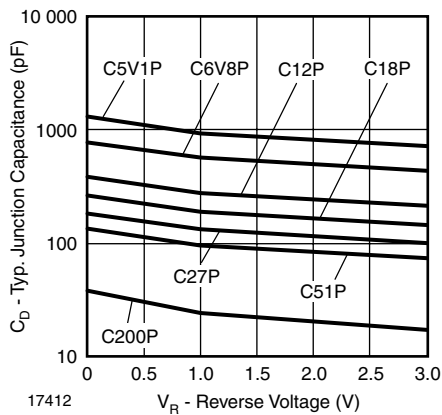

Figure 2. Typ. Diode Capacitance vs. Reverse Voltage

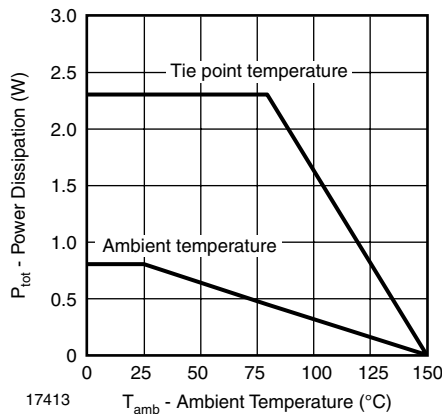

Figure 3. Power Dissipation vs. Ambient Temperature

BZD17C3V6P to BZD17C200P



Vishay Semiconductors

Package Dimensions in millimeters (inches): DO219AB

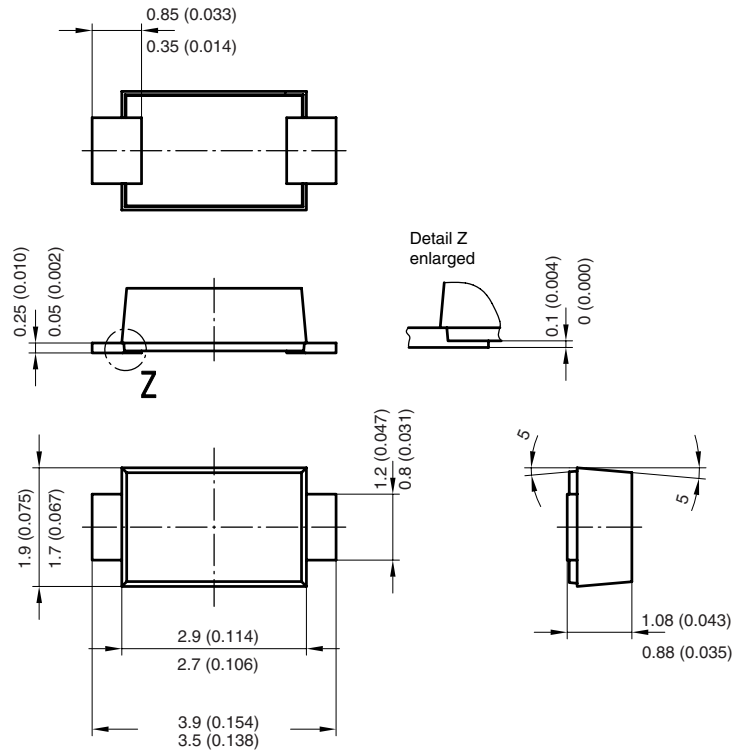

Foot print recommendation:

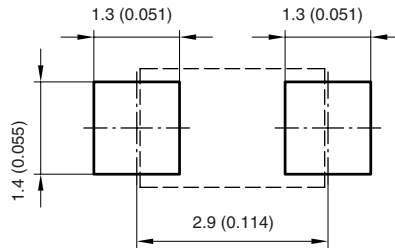

Created - Date: 15. February 2005
Rev. 3 - Date: 13. March 2007
Document no.:S8-V-3915.01-001 (4)
17247

Blisertape for SMF Dimensions in millimeters

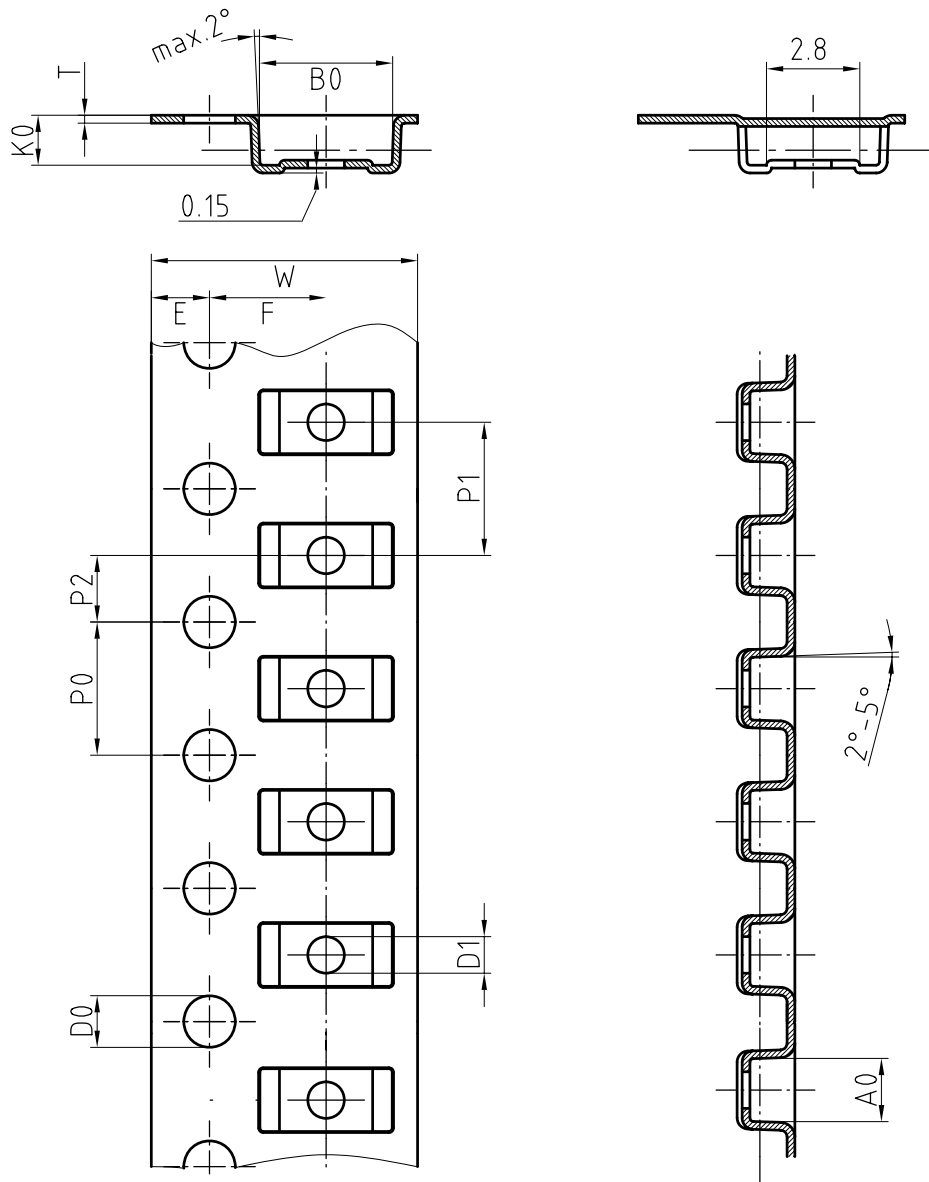

Mat:	A0	B0	K0	W	T	P0	P2	P1	D0	D1	E	F
PS	1.9	4.0	1.5	8.0	0.235	4.0	2.0	4.0	1.5	1	1.75	3.5

18513

Looking for pricing, stock, or lifecycle information?

Click below to explore more details on WIN SOURCE:

 [View BZD17C39P-E3-08 on WIN SOURCE](#)

 [Vishay Information](#)

Optimize Your Supply Chain with WIN SOURCE Solutions

-  Global Sourcing Solution
-  Obsolete Management
-  Cost Control Management
-  Shortage Management
-  Alternative Solution
-  Excess Inventory Management