



**THE DATASHEET OF
NIF62514T3G**



NIF62514

Self-Protected FET with Temperature and Current Limit

HDPlus devices are an advanced series of power MOSFETs which utilize ON Semiconductor's latest MOSFET technology process to achieve the lowest possible on-resistance per silicon area while incorporating smart features. Integrated thermal and current limits work together to provide short circuit protection. The devices feature an integrated Drain-to-Gate Clamp that enables them to withstand high energy in the avalanche mode. The Clamp also provides additional safety margin against unexpected voltage transients. Electrostatic Discharge (ESD) protection is provided by an integrated Gate-to-Source Clamp.

Features

- Current Limitation
- Thermal Shutdown with Automatic Restart
- Short Circuit Protection
- Low $R_{DS(on)}$
- I_{DSS} Specified at Elevated Temperature
- Avalanche Energy Specified
- Slew Rate Control for Low Noise Switching
- Overvoltage Clamped Protection
- This is a Pb-Free Device



ON Semiconductor®

<http://onsemi.com>

**6.0 AMPERES*
40 VOLTS CLAMPED**

$R_{DS(on)} = 90 \text{ m}\Omega$

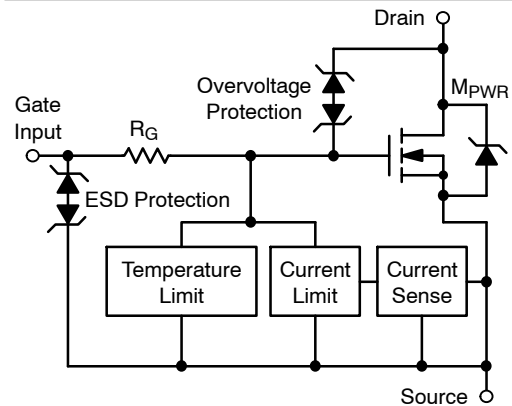

MARKING DIAGRAM

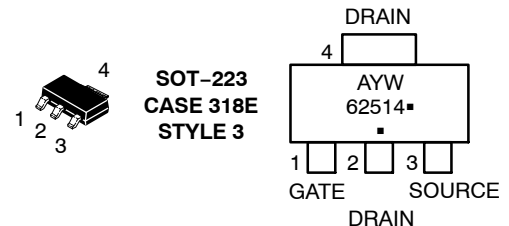

A = Assembly Location

Y = Year

W = Work Week

62514 = Specific Device Code

▪ = Pb-Free Package

(Note: Microdot may be in either location)

ORDERING INFORMATION

| Device | Package | Shipping† |
|-------------|-------------------|------------------|
| NIF62514T1G | SOT-223 (Pb-Free) | 1000/Tape & Reel |
| NIF62514T3G | SOT-223 (Pb-Free) | 4000/Tape & Reel |

†For information on tape and reel specifications, including part orientation and tape sizes, please refer to our Tape and Reel Packaging Specification Brochure, BRD8011/D.

*Limited by the current limit circuit.

NIF62514

MOSFET MAXIMUM RATINGS ($T_J = 25^\circ\text{C}$ unless otherwise noted)

| Rating | Symbol | Value | Unit |
|---|---|---------------------|--------------------|
| Drain-to-Source Voltage Internally Clamped | V_{DSS} | 40 | Vdc |
| Drain-to-Gate Voltage Internally Clamped ($R_{GS} = 1.0\text{ M}\Omega$) | V_{DGR} | 40 | Vdc |
| Gate-to-Source Voltage | V_{GS} | ± 16 | Vdc |
| Drain Current - Continuous @ $T_A = 25^\circ\text{C}$ - Continuous @ $T_A = 100^\circ\text{C}$ - Pulsed ($t_p \leq 10\ \mu\text{s}$) | I_D I_{D1} I_{DM} | Internally Limited | |
| Total Power Dissipation @ $T_A = 25^\circ\text{C}$ (Note 1) @ $T_A = 25^\circ\text{C}$ (Note 2) @ $T_A = 25^\circ\text{C}$ (Note 3) | P_D | 1.1 1.73 8.93 | W |
| Thermal Resistance, Junction-to-Tab Junction-to-Ambient (Note 1) Junction-to-Ambient (Note 2) | $R_{\theta JT}$ $R_{\theta JA}$ $R_{\theta JA}$ | 14 114 72.3 | $^\circ\text{C/W}$ |
| Single Pulse Drain-to-Source Avalanche Energy ($V_{DD} = 25\text{ Vdc}$, $V_{GS} = 5.0\text{ Vdc}$, $V_{DS} = 40\text{ Vdc}$, $I_L = 2.8\text{ Apk}$, $L = 80\text{ mH}$, $R_G = 25\ \Omega$) | E_{AS} | 300 | mJ |
| Operating and Storage Temperature Range | T_J, T_{stg} | -55 to 150 | $^\circ\text{C}$ |

Stresses exceeding Maximum Ratings may damage the device. Maximum Ratings are stress ratings only. Functional operation above the Recommended Operating Conditions is not implied. Extended exposure to stresses above the Recommended Operating Conditions may affect device reliability.

1. Mounted onto min pad board.
2. Mounted onto 1" pad board.
3. Mounted onto large heatsink.

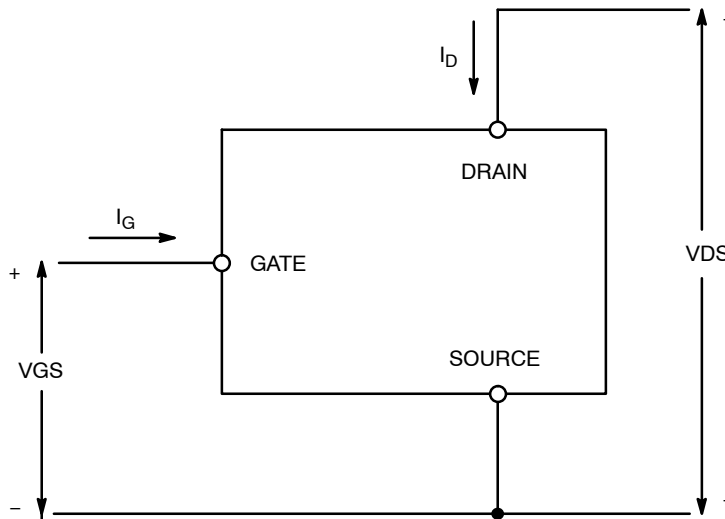

Figure 1. Voltage and Current Convention

NIF62514

MOSFET ELECTRICAL CHARACTERISTICS (T_J = 25°C unless otherwise noted)

| Characteristic | Symbol | Min | Typ | Max | Unit |
|----------------|--------|-----|-----|-----|------|
|----------------|--------|-----|-----|-----|------|

OFF CHARACTERISTICS

| | | | | | |
|--|----------------------|----------|------------|-------------|------|
| Drain-to-Source Clamped Breakdown Voltage (V _{GS} = 0 Vdc, I _D = 250 μAdc) (V _{GS} = 0 Vdc, I _D = 250 μAdc, T _J = 150°C) (Note 4) | V _{(BR)DSS} | 42 42 | 46 45 | 50 50 | Vdc |
| Zero Gate Voltage Drain Current (V _{DS} = 32 Vdc, V _{GS} = 0 Vdc) (V _{DS} = 32 Vdc, V _{GS} = 0 Vdc, T _J = 150°C) (Note 4) | I _{DSS} | - - | 0.5 2.0 | 2.0 10 | μAdc |
| Gate Input Current (V _{GS} = 5.0 Vdc, V _{DS} = 0 Vdc) (V _{GS} = -5.0 Vdc, V _{DS} = 0 Vdc) | I _{GSS} | - - | 50 550 | 100 1000 | μAdc |

ON CHARACTERISTICS

| | | | | | |
|---|---------------------|----------|------------|------------|--------------|
| Gate Threshold Voltage (V _{DS} = V _{GS} , I _D = 150 μAdc) Threshold Temperature Coefficient (Negative) | V _{GS(th)} | 1.0 - | 1.7 4.0 | 2.0 - | Vdc mV/°C |
| Static Drain-to-Source On-Resistance (Note 5) (V _{GS} = 10 Vdc, I _D = 1.4 Adc, T _J @ 25°C) (V _{GS} = 10 Vdc, I _D = 1.4 Adc, T _J @ 150°C) (Note 4) | R _{DS(on)} | - - | 90 165 | 100 190 | mΩ |
| Static Drain-to-Source On-Resistance (Note 5) (V _{GS} = 5.0 Vdc, I _D = 1.4 Adc, T _J @ 25°C) (V _{GS} = 5.0 Vdc, I _D = 1.4 Adc, T _J @ 150°C) (Note 4) | R _{DS(on)} | - - | 105 185 | 120 210 | mΩ |
| Source-Drain Forward On Voltage (I _S = 7 A, V _{GS} = 0 V) | V _{SD} | - | 1.05 | - | V |

SWITCHING CHARACTERISTICS (Note 4)

| | | | | | |
|--|-------------------------------------|---|-----|-----|----|
| Turn-on Delay Time R _L = 4.7 Ω, V _{in} = 0 to 10 V, V _{DD} = 12 V | t _{d(on)} | - | 4.0 | 8.0 | μs |
| Turn-on Rise Time R _L = 4.7 Ω, V _{in} = 0 to 10 V, V _{DD} = 12 V | t _{rise} | - | 11 | 20 | μs |
| Turn-off Delay Time R _L = 4.7 Ω, V _{in} = 10 to 0 V, V _{DD} = 12 V | t _{d(off)} | - | 32 | 50 | μs |
| Turn-off Fall Time R _L = 4.7 Ω, V _{in} = 10 to 0 V, V _{DD} = 12 V | t _{fall} | - | 27 | 50 | μs |
| Slew-Rate On R _L = 4.7 Ω, V _{in} = 0 to 10 V, V _{DD} = 12 V | -dV _{DS} /dt _{on} | - | 1.5 | 2.5 | μs |
| Slew-Rate Off R _L = 4.7 Ω, V _{in} = 10 to 0 V, V _{DD} = 12 V | dV _{DS} /dt _{off} | - | 0.6 | 1.0 | μs |

SELF PROTECTION CHARACTERISTICS (T_J = 25°C unless otherwise noted)

| | | | | | |
|--|-----------------------|------------|-------------|-----------|-----|
| Current Limit (V _{GS} = 5.0 Vdc) (V _{GS} = 5.0 Vdc, T _J = 150°C) (Note 4) | I _{LIM} | 6.0 3.0 | 9.0 5.0 | 11 8.0 | Adc |
| Current Limit (V _{GS} = 10 Vdc) (V _{GS} = 10 Vdc, T _J = 150°C) (Note 4) | I _{LIM} | 7.0 4.0 | 10.5 7.5 | 13 10 | Adc |
| Temperature Limit (Turn-off) (Note 4) | T _{LIM(off)} | 150 | 175 | 200 | °C |
| Temperature Hysteresis (Note 4) | ΔT _{LIM(on)} | - | 15 | - | °C |
| Temperature Limit (Turn-off) (Note 4) | T _{LIM(off)} | 150 | 165 | 185 | °C |
| Temperature Hysteresis (Note 4) | ΔT _{LIM(on)} | - | 15 | - | °C |

ESD ELECTRICAL CHARACTERISTICS (T_J = 25°C unless otherwise noted)

| | | | | | | |
|-------------------------------------|------------------------|-----|------|---|---|---|
| Electro-Static Discharge Capability | Human Body Model (HBM) | ESD | 4000 | - | - | V |
| Electro-Static Discharge Capability | Machine Model (MM) | ESD | 400 | - | - | V |

- Not subject to production testing.
- Pulse Test: Pulse Width = 300 μs, Duty Cycle = 2%.

TYPICAL ELECTRICAL CHARACTERISTICS

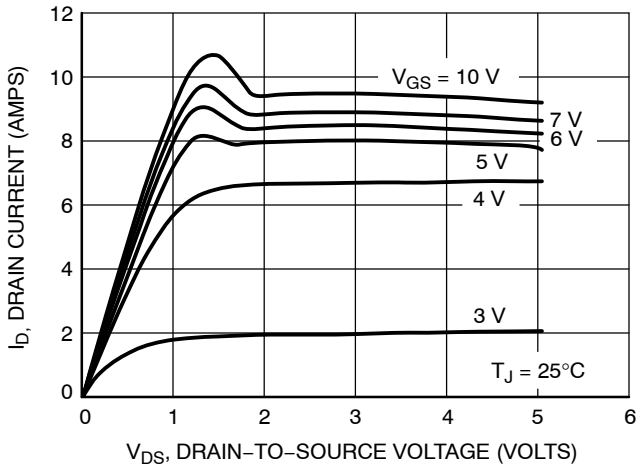

Figure 1. Output Characteristics

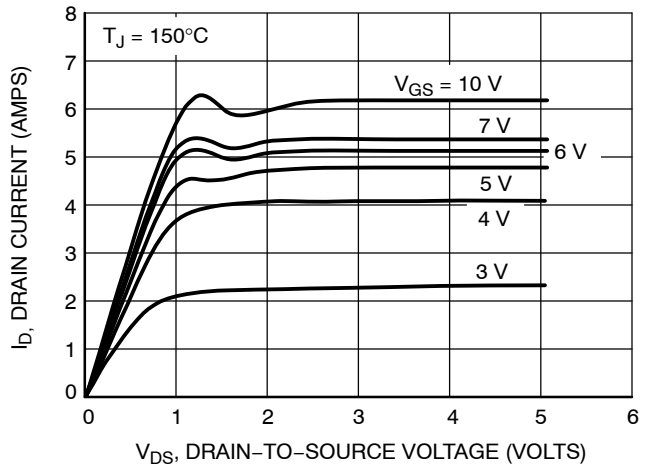

Figure 2. Output Characteristics

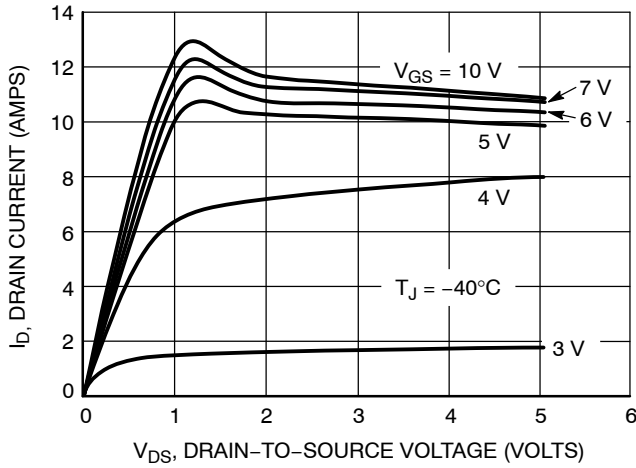

Figure 3. Output Characteristics

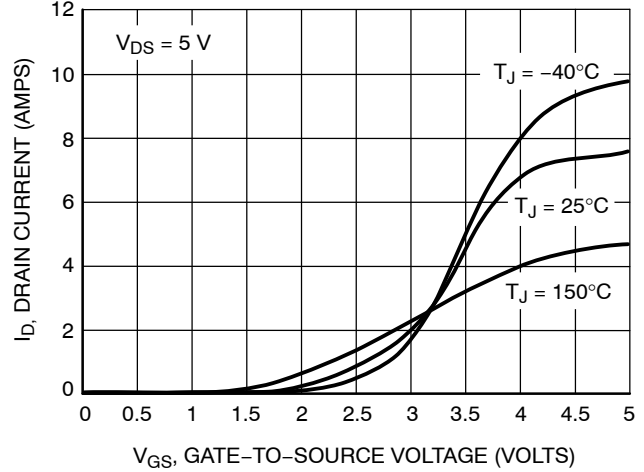

Figure 4. Transfer Characteristics

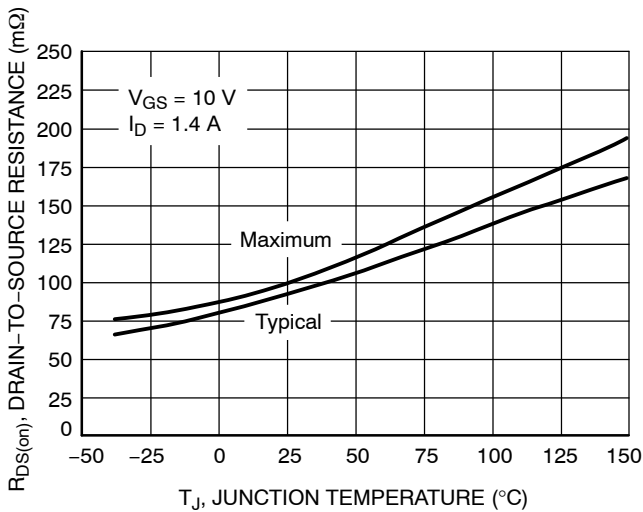

Figure 5. Drain-to-Source Resistance versus Junction Temperature

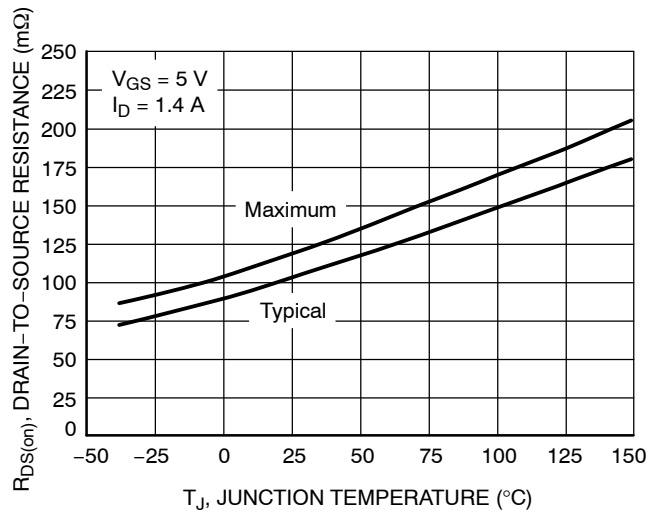

Figure 6. Drain-to-Source Resistance versus Junction Temperature

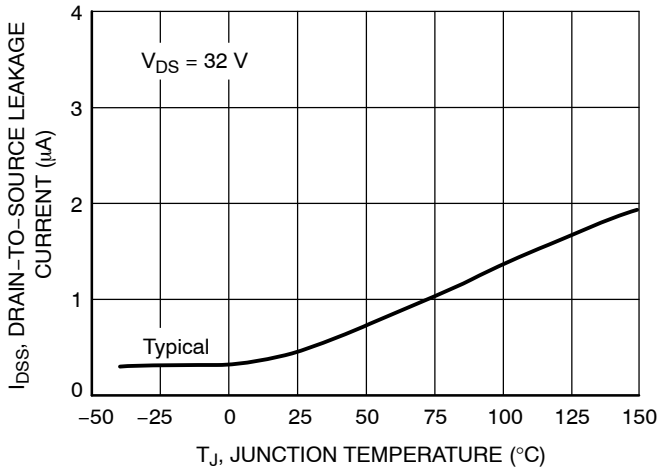

Figure 7. Drain-to-Source Resistance versus Junction Temperature

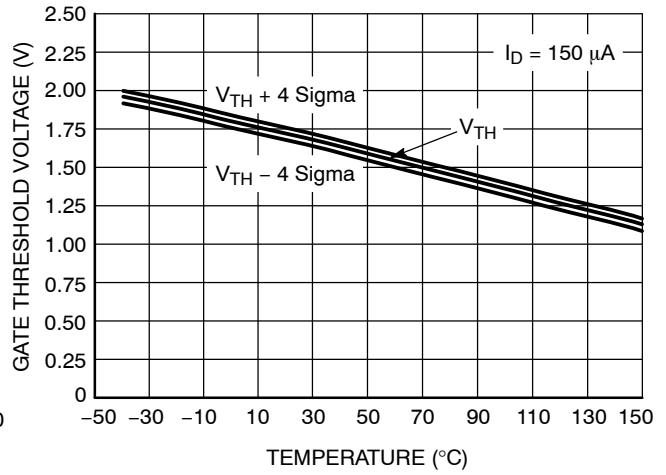

Figure 8. Gate Threshold Voltage versus Temperature

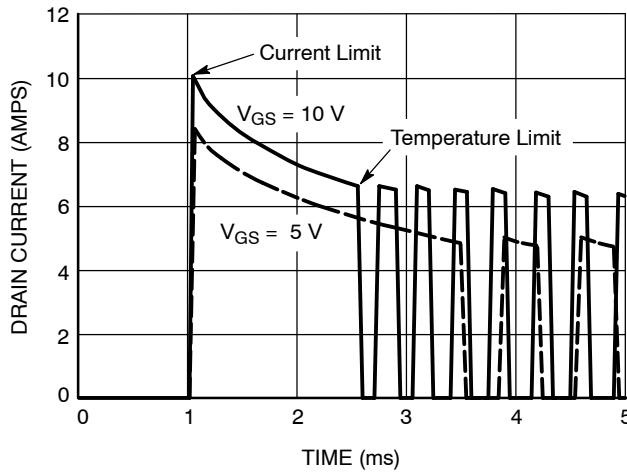

Figure 9. Short-circuit Response

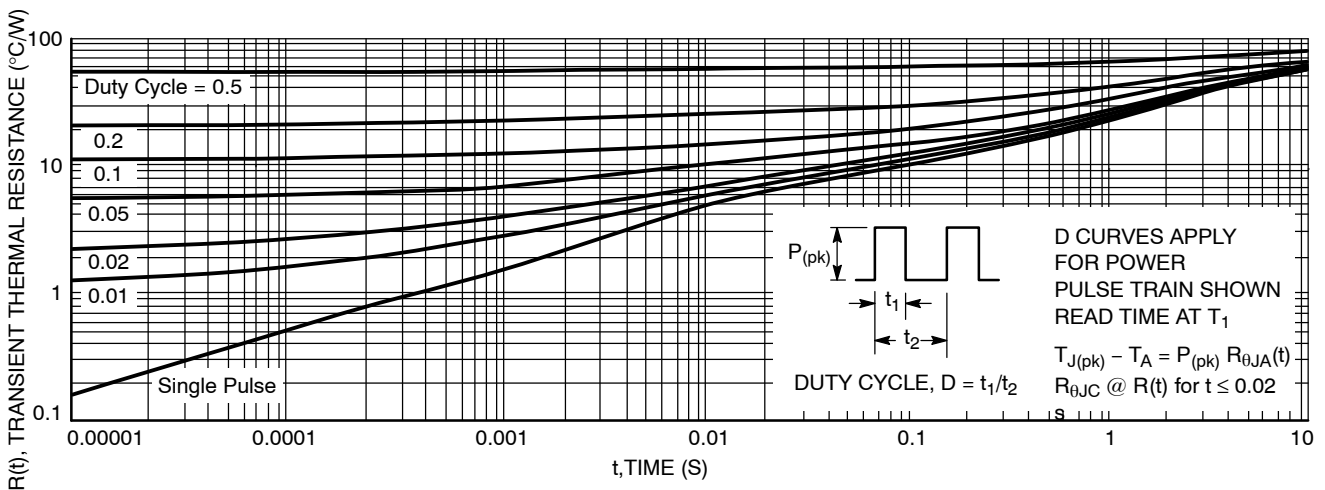
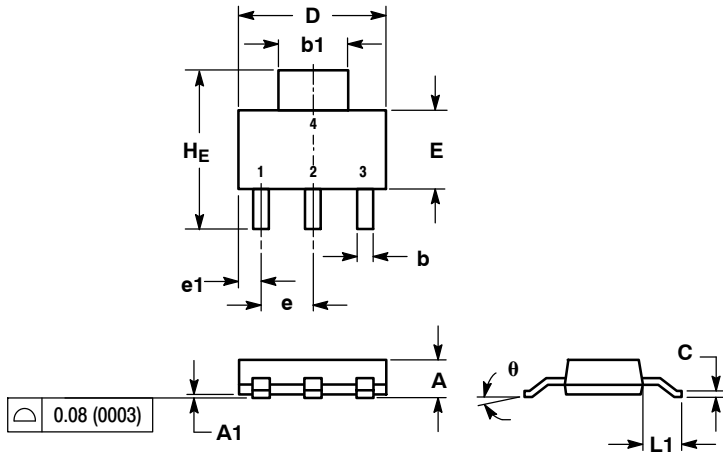

Figure 10. Transient Thermal Resistance (Non-normalized Junction-to-Ambient mounted on minimum pad area)

NIF62514

PACKAGE DIMENSIONS

SOT-223 (TO-261)
CASE 318E-04
ISSUE M



NOTES:

1. DIMENSIONING AND TOLERANCING PER ANSI Y14.5M, 1982.
2. CONTROLLING DIMENSION: INCH.

| DIM | MILLIMETERS | | | INCHES | | |
|-------|-------------|------|------|--------|-------|-------|
| | MIN | NOM | MAX | MIN | NOM | MAX |
| A | 1.50 | 1.63 | 1.75 | 0.060 | 0.064 | 0.068 |
| A1 | 0.02 | 0.06 | 0.10 | 0.001 | 0.002 | 0.004 |
| b | 0.60 | 0.75 | 0.89 | 0.024 | 0.030 | 0.035 |
| b1 | 2.90 | 3.06 | 3.20 | 0.115 | 0.121 | 0.126 |
| c | 0.24 | 0.29 | 0.35 | 0.009 | 0.012 | 0.014 |
| D | 6.30 | 6.50 | 6.70 | 0.249 | 0.256 | 0.263 |
| E | 3.30 | 3.50 | 3.70 | 0.130 | 0.138 | 0.145 |
| e | 2.20 | 2.30 | 2.40 | 0.087 | 0.091 | 0.094 |
| e1 | 0.85 | 0.94 | 1.05 | 0.033 | 0.037 | 0.041 |
| L1 | 1.50 | 1.75 | 2.00 | 0.060 | 0.069 | 0.078 |
| HE | 6.70 | 7.00 | 7.30 | 0.264 | 0.276 | 0.287 |
| theta | 0° | - | 10° | 0° | - | 10° |

STYLE 3:

- PIN 1. GATE
- DRAIN
- SOURCE
- DRAIN

SOLDERING FOOTPRINT

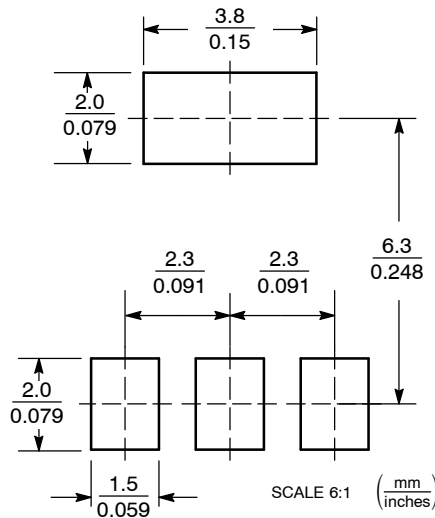

*For additional information on our Pb-Free strategy and soldering details, please download the ON Semiconductor Soldering and Mounting Techniques Reference Manual, SOLDERRM/D.

ON Semiconductor and are registered trademarks of Semiconductor Components Industries, LLC (SCILLC). SCILLC reserves the right to make changes without further notice to any products herein. SCILLC makes no warranty, representation or guarantee regarding the suitability of its products for any particular purpose, nor does SCILLC assume any liability arising out of the application or use of any product or circuit, and specifically disclaims any and all liability, including without limitation special, consequential or incidental damages. "Typical" parameters which may be provided in SCILLC data sheets and/or specifications can and do vary in different applications and actual performance may vary over time. All operating parameters, including "Typicals" must be validated for each customer application by customer's technical experts. SCILLC does not convey any license under its patent rights nor the rights of others. SCILLC products are not designed, intended, or authorized for use as components in systems intended for surgical implant into the body, or other applications intended to support or sustain life, or for any other application in which the failure of the SCILLC product could create a situation where personal injury or death may occur. Should Buyer purchase or use SCILLC products for any such unintended or unauthorized application, Buyer shall indemnify and hold SCILLC and its officers, employees, subsidiaries, affiliates, and distributors harmless against all claims, costs, damages, and expenses, and reasonable attorney fees arising out of, directly or indirectly, any claim of personal injury or death associated with such unintended or unauthorized use, even if such claim alleges that SCILLC was negligent regarding the design or manufacture of the part. SCILLC is an Equal Opportunity/Affirmative Action Employer. This literature is subject to all applicable copyright laws and is not for resale in any manner.

PUBLICATION ORDERING INFORMATION

LITERATURE FULFILLMENT:

Literature Distribution Center for ON Semiconductor
P.O. Box 5163, Denver, Colorado 80217 USA
Phone: 303-675-2175 or 800-344-3860 Toll Free USA/Canada
Fax: 303-675-2176 or 800-344-3867 Toll Free USA/Canada
Email: orderlit@onsemi.com

N. American Technical Support: 800-282-9855 Toll Free
USA/Canada
Europe, Middle East and Africa Technical Support:
Phone: 421 33 790 2910
Japan Customer Focus Center
Phone: 81-3-5773-3850

ON Semiconductor Website: www.onsemi.com

Order Literature: <http://www.onsemi.com/orderlit>

For additional information, please contact your local Sales Representative

Looking for pricing, stock, or lifecycle information?

Click below to explore more details on WIN SOURCE:

 [View NIF62514T3G on WIN SOURCE](#)

 [ON Semiconductor](#) Information

Optimize Your Supply Chain with WIN SOURCE Solutions

-  Global Sourcing Solution
-  Obsolete Management
-  Cost Control Management
-  Shortage Management
-  Alternative Solution
-  Excess Inventory Management