



**THE DATASHEET OF
74LV14DB,118**



74LV14

Hex inverting Schmitt trigger

Rev. 7 — 9 December 2015

Product data sheet

1. General description

The 74LV14 is a low-voltage Si-gate CMOS device that is pin and function compatible with 74HC14 and 74HCT14.

The 74LV14 provides six inverting buffers with Schmitt-trigger input. It is capable of transforming slowly-changing input signals into sharply defined, jitter-free output signals.

The inputs switch at different points for positive and negative-going signals. The difference between the positive voltage V_{T+} and the negative voltage V_{T-} is defined as the input hysteresis voltage V_H .

2. Features and benefits

- Wide operating voltage: 1.0 V to 5.5 V
- Optimized for low voltage applications: 1.0 V to 3.6 V
- Accepts TTL input levels between $V_{CC} = 2.7$ V and $V_{CC} = 3.6$ V
- Typical output ground bounce < 0.8 V at $V_{CC} = 3.3$ V and $T_{amb} = 25$ °C
- Typical HIGH-level output voltage (V_{OH}) undershoot: > 2 V at $V_{CC} = 3.3$ V and $T_{amb} = 25$ °C
- ESD protection:
 - ◆ HBM JESD22-A114F exceeds 2000 V
 - ◆ MM JESD22-A115-A exceeds 200 V
- Multiple package options
- Specified from -40 °C to +85 °C and from -40 °C to +125 °C

3. Applications

- Wave and pulse shapers for highly noisy environments
- Astable multivibrators
- Monostable multivibrators

4. Ordering information

Table 1. Ordering information

Type number	Package			Version
	Temperature range	Name	Description	
74LV14D	-40 °C to +125 °C	SO14	plastic small outline package; 14 leads; body width 3.9 mm	SOT108-1
74LV14DB	-40 °C to +125 °C	SSOP14	plastic shrink small outline package; 14 leads; body width 5.3 mm	SOT337-1
74LV14PW	-40 °C to +125 °C	TSSOP14	plastic thin shrink small outline package; 14 leads; body width 4.4 mm	SOT402-1
74LV14BQ	-40 °C to +125 °C	DHVQFN14	plastic dual in-line compatible thermal enhanced very thin quad flat package; no leads; 14 terminals; body 2.5 × 3 × 0.85 mm	SOT762-1

5. Functional diagram

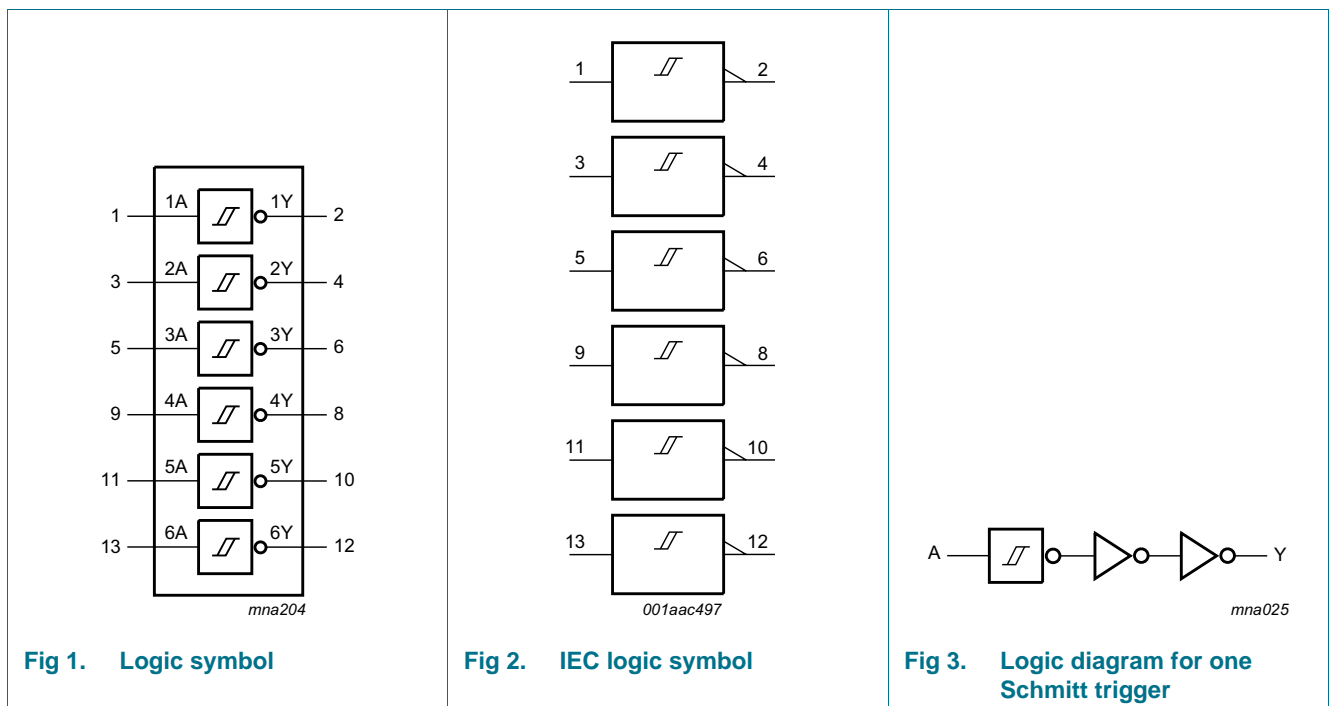

6. Pinning information

6.1 Pinning

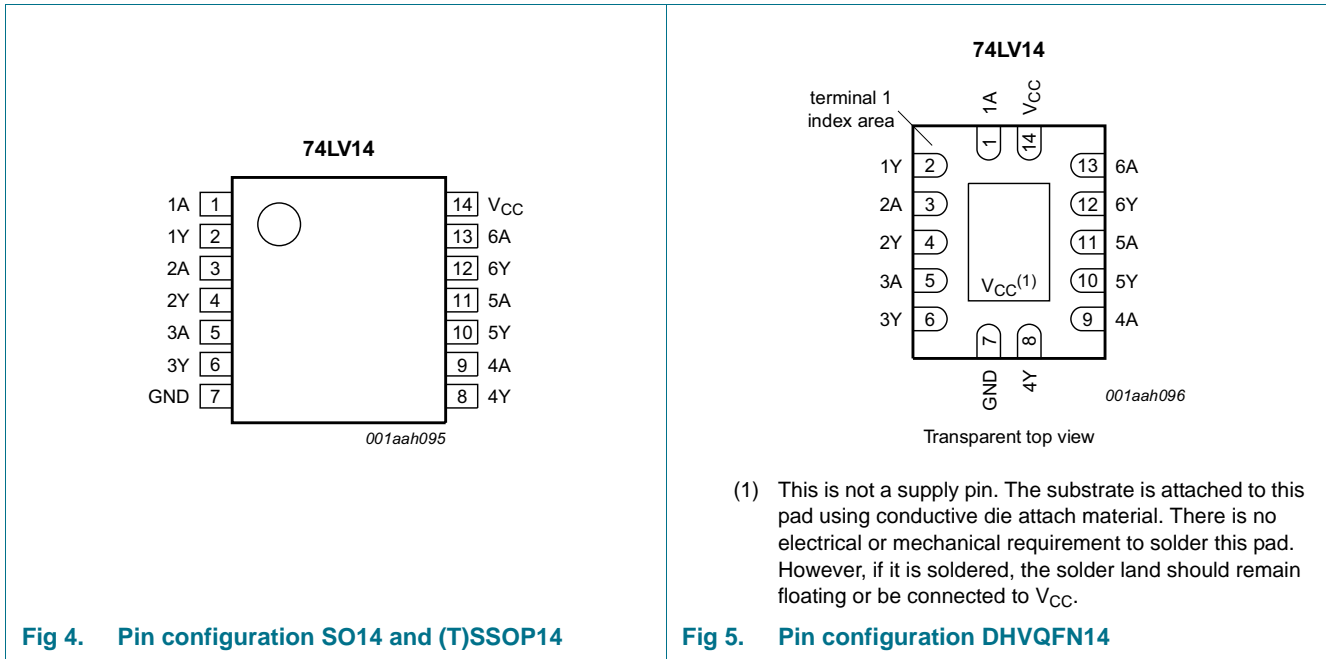

6.2 Pin description

Table 2. Pin description

Symbol	Pin	Description
1A	1	data input
1Y	2	data output
2A	3	data input
2Y	4	data output
3A	5	data input
3Y	6	data output
GND	7	ground (0 V)
4Y	8	data output
4A	9	data input
5Y	10	data output
5A	11	data input
6Y	12	data output
6A	13	data input
V _{CC}	14	supply voltage

7. Functional description

Table 3. Function table

H = HIGH voltage level; L = LOW voltage level.

Input nA	Output nY
L	H
H	L

8. Limiting values

Table 4. Limiting values

In accordance with the Absolute Maximum Rating System (IEC 60134). Voltages are referenced to GND (ground = 0 V).

Symbol	Parameter	Conditions	Min	Max	Unit
V_{CC}	supply voltage		-0.5	+7.0	V
I_{IK}	input clamping current	$V_I < -0.5\text{ V}$ or $V_I > V_{CC} + 0.5\text{ V}$ [1]	-	±20	mA
I_{OK}	output clamping current	$V_O < -0.5\text{ V}$ or $V_O > V_{CC} + 0.5\text{ V}$ [1]	-	±50	mA
I_O	output current	$V_O = -0.5\text{ V}$ to $(V_{CC} + 0.5\text{ V})$	-	±25	mA
I_{CC}	supply current		-	50	mA
I_{GND}	ground current		-50	-	mA
T_{stg}	storage temperature		-65	+150	°C
P_{tot}	total power dissipation	$T_{amb} = -40\text{ °C}$ to $+125\text{ °C}$			
		SO14 package [2]	-	500	mW
		(T)SSOP14 package [3]	-	500	mW
		DHVQFN14 package [4]	-	500	mW

[1] The input and output voltage ratings may be exceeded if the input and output current ratings are observed.

[2] P_{tot} derates linearly with 8 mW/K above 70 °C.

[3] P_{tot} derates linearly with 5.5 mW/K above 60 °C.

[4] P_{tot} derates linearly with 4.5 mW/K above 60 °C.

9. Recommended operating conditions

Table 5. Recommended operating conditions

Voltages are referenced to GND (ground = 0 V).

Symbol	Parameter	Conditions	Min	Typ	Max	Unit
V_{CC}	supply voltage	[1]	1.0	3.3	5.5	V
V_I	input voltage		0	-	V_{CC}	V
V_O	output voltage		0	-	V_{CC}	V
T_{amb}	ambient temperature		-40	+25	+125	°C

[1] The static characteristics are guaranteed from $V_{CC} = 1.2\text{ V}$ to $V_{CC} = 5.5\text{ V}$, but LV devices are guaranteed to function down to $V_{CC} = 1.0\text{ V}$ (with input levels GND or V_{CC}).

10. Static characteristics

Table 6. Static characteristics

Voltages are referenced to GND (ground = 0 V).

Symbol	Parameter	Conditions	T _{amb} = -40 °C to +85 °C			T _{amb} = -40 °C to +125 °C		Unit
			Min	Typ ^[1]	Max	Min	Max	
V _{OH}	HIGH-level output voltage	V _I = V _{T+} or V _{T-}						
		I _O = -100 μA; V _{CC} = 1.2 V	-	1.2	-	-	-	V
		I _O = -100 μA; V _{CC} = 2.0 V	1.8	2.0	-	1.8	-	V
		I _O = -100 μA; V _{CC} = 2.7 V	2.5	2.7	-	2.5	-	V
		I _O = -100 μA; V _{CC} = 3.0 V	2.8	3.0	-	2.8	-	V
		I _O = -100 μA; V _{CC} = 4.5 V	4.3	4.5	-	4.3	-	V
		I _O = -6 mA; V _{CC} = 3.0 V	2.4	2.82	-	2.2	-	V
		I _O = -12 mA; V _{CC} = 4.5 V	3.6	4.2	-	3.5	-	V
V _{OL}	LOW-level output voltage	V _I = V _{T+} or V _{T-}						
		I _O = 100 μA; V _{CC} = 1.2 V	-	0	-	-	-	V
		I _O = 100 μA; V _{CC} = 2.0 V	-	0	0.2	-	0.2	V
		I _O = 100 μA; V _{CC} = 2.7 V	-	0	0.2	-	0.2	V
		I _O = 100 μA; V _{CC} = 3.0 V	-	0	0.2	-	0.2	V
		I _O = 100 μA; V _{CC} = 4.5 V	-	0	0.2	-	0.2	V
		I _O = 6 mA; V _{CC} = 3.0 V	-	0.25	0.40	-	0.50	V
		I _O = 12 mA; V _{CC} = 4.5 V	-	0.35	0.55	-	0.65	V
I _I	input leakage current	V _I = V _{CC} or GND; V _{CC} = 5.5 V	-	-	1.0	-	1.0	μA
I _{CC}	supply current	V _I = V _{CC} or GND; I _O = 0 A; V _{CC} = 5.5 V	-	-	20.0	-	40	μA
ΔI _{CC}	additional supply current	per input; V _I = V _{CC} - 0.6 V; V _{CC} = 2.7 V to 3.6 V	-	-	500	-	850	μA
C _I	input capacitance		-	3.5	-	-	-	pF

[1] Typical values are measured at T_{amb} = 25 °C.

11. Dynamic characteristics

Table 7. Dynamic characteristics
GND = 0 V; For test circuit see Figure 7.

Symbol	Parameter	Conditions	T _{amb} = -40 °C to +85 °C			T _{amb} = -40 °C to +125 °C		Unit
			Min	Typ ^[1]	Max	Min	Max	
t _{pd}	propagation delay	nA to nY; see Figure 6 ^[2]						
		V _{CC} = 1.2 V	-	80	-	-	-	ns
		V _{CC} = 2.0 V	-	27	37	-	48	ns
		V _{CC} = 2.7 V	-	20	28	-	35	ns
		V _{CC} = 3.0 V to 3.6 V; C _L = 15 pF ^[3]	-	13	-	-	-	ns
		V _{CC} = 3.0 V to 3.6 V ^[3]	-	15	22	-	28	ns
C _{PD}	power dissipation capacitance	C _L = 50 pF; f _i = 1 MHz; V _I = GND to V _{CC} ^[4]	-	15	-	-	-	pF

- [1] All typical values are measured at T_{amb} = 25 °C.
- [2] t_{pd} is the same as t_{PLH} and t_{PHL}.
- [3] Typical values are measured at nominal supply voltage (V_{CC} = 3.3 V).
- [4] C_{PD} is used to determine the dynamic power dissipation (P_D in μW).
 $P_D = C_{PD} \times V_{CC}^2 \times f_i \times N + \Sigma(C_L \times V_{CC}^2 \times f_o)$ where:
 f_i = input frequency in MHz, f_o = output frequency in MHz
 C_L = output load capacitance in pF
 V_{CC} = supply voltage in V
 N = number of inputs switching
 $\Sigma(C_L \times V_{CC}^2 \times f_o)$ = sum of the outputs.

12. Waveforms

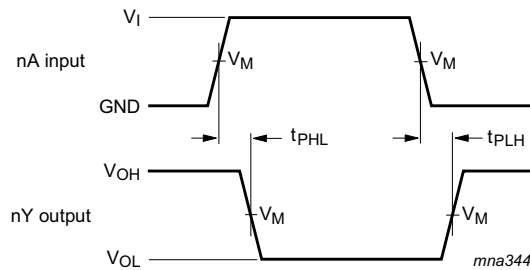

Measurement points are given in [Table 8](#).
 V_{OL} and V_{OH} are typical voltage output levels that occur with the output load.

Fig 6. The input (nA) to output (nY) propagation delays

Table 8. Measurement points

Supply voltage	Input	Output
V_{CC}	V_M	V_M
< 2.7 V	$0.5V_{CC}$	$0.5V_{CC}$
2.7 V to 3.6 V	1.5 V	1.5 V
≥ 4.5 V	$0.5V_{CC}$	$0.5V_{CC}$

Test data is given in [Table 9](#).

Definitions test circuit:

- R_T = Termination resistance should be equal to output impedance Z_o of the pulse generator.
- R_L = Load resistance.
- C_L = Load capacitance including jig and probe capacitance.

Fig 7. Test circuit for measuring switching times

Table 9. Test data

Supply voltage	Input	
V_{CC}	V_I	t_r, t_f
< 2.7 V	V_{CC}	≤ 2.5 ns
2.7 V to 3.6 V	2.7 V	≤ 2.5 ns
≥ 4.5 V	V_{CC}	≤ 2.5 ns

13. Transfer characteristics

Table 10. Transfer characteristics

At recommended operating conditions; voltages are referenced to GND (ground = 0 V); see [Figure 8](#) and [Figure 9](#).

Symbol	Parameter	Conditions	$T_{amb} = -40\text{ }^{\circ}\text{C}$ to $+85\text{ }^{\circ}\text{C}$			$T_{amb} = -40\text{ }^{\circ}\text{C}$ to $+125\text{ }^{\circ}\text{C}$		Unit
			Min	Typ ^[1]	Max	Min	Max	
V_{T+}	positive-going threshold voltage	$V_{CC} = 1.2$ V	-	0.70	-	-	-	V
		$V_{CC} = 2.0$ V	0.8	1.10	1.4	0.8	1.4	V
		$V_{CC} = 2.7$ V	1.0	1.45	2.0	1.0	2.0	V
		$V_{CC} = 3.0$ V	1.2	1.60	2.2	1.2	2.2	V
		$V_{CC} = 3.6$ V	1.5	1.95	2.4	1.5	2.4	V
		$V_{CC} = 4.5$ V	1.7	2.50	3.15	1.7	3.15	V
		$V_{CC} = 5.5$ V	2.1	3.00	3.85	2.1	3.85	V

Table 10. Transfer characteristics ...continued

At recommended operating conditions; voltages are referenced to GND (ground = 0 V); see [Figure 8](#) and [Figure 9](#).

Symbol	Parameter	Conditions	T _{amb} = -40 °C to +85 °C			T _{amb} = -40 °C to +125 °C		Unit
			Min	Typ ^[1]	Max	Min	Max	
V _{T-}	negative-going threshold voltage	V _{CC} = 1.2 V	-	0.34	-	-	-	V
		V _{CC} = 2.0 V	0.3	0.65	0.9	0.3	0.9	V
		V _{CC} = 2.7 V	0.4	0.90	1.4	0.4	1.4	V
		V _{CC} = 3.0 V	0.6	1.05	1.5	0.6	1.5	V
		V _{CC} = 3.6 V	0.8	1.30	1.8	0.8	1.8	V
		V _{CC} = 4.5 V	0.9	1.60	2.0	0.9	2.0	V
		V _{CC} = 5.5 V	1.1	2.00	2.6	1.1	2.6	V
V _H	hysteresis voltage	V _{CC} = 1.2 V	-	0.3	-	-	-	V
		V _{CC} = 2.0 V	0.2	0.55	0.8	0.2	0.8	V
		V _{CC} = 2.7 V	0.3	0.60	1.1	0.3	1.1	V
		V _{CC} = 3.0 V	0.4	0.65	1.2	0.4	1.2	V
		V _{CC} = 3.6 V	0.4	0.70	1.2	0.4	1.2	V
		V _{CC} = 4.5 V	0.4	0.80	1.4	0.4	1.4	V
		V _{CC} = 5.5 V	0.6	1.00	1.5	0.6	1.5	V

[1] All typical values are measured at T_{amb} = 25 °C.

14. Waveforms transfer characteristics

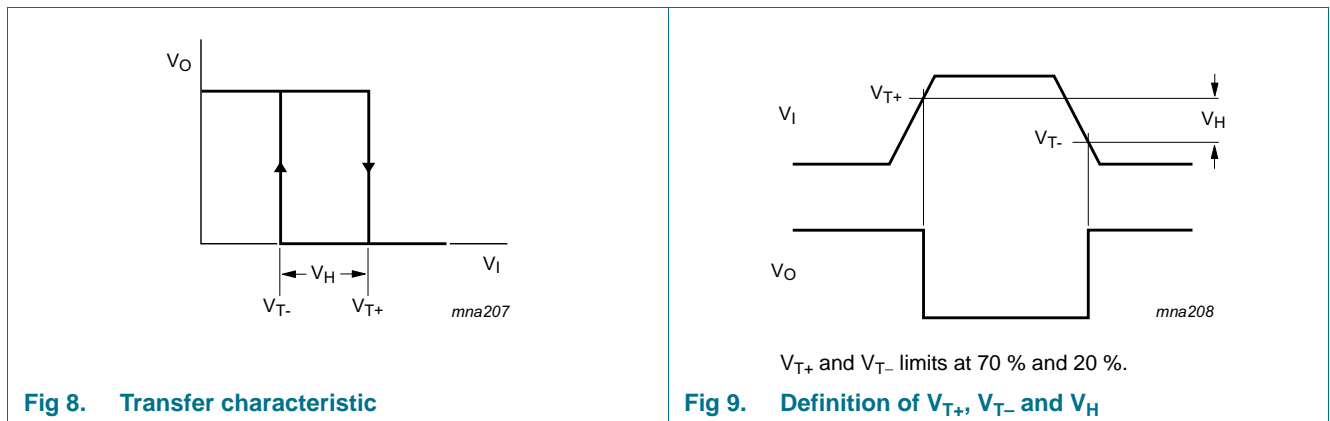

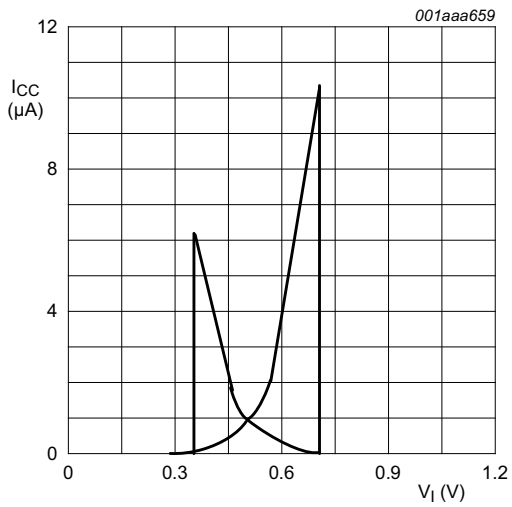

$V_{CC} = 1.2$ V.

Fig 10. Typical 74LV14 transfer characteristics

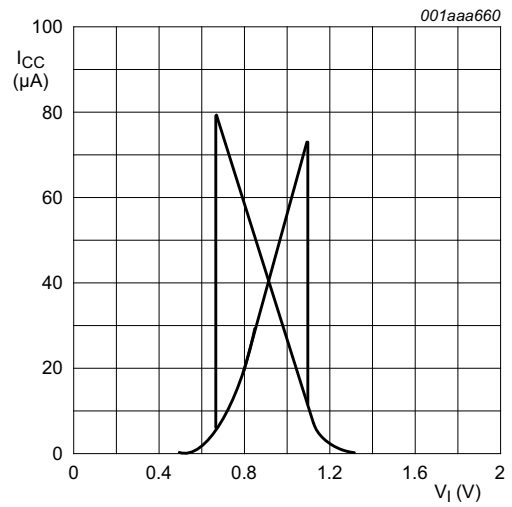

$V_{CC} = 2.0$ V.

Fig 11. Typical 74LV14 transfer characteristics

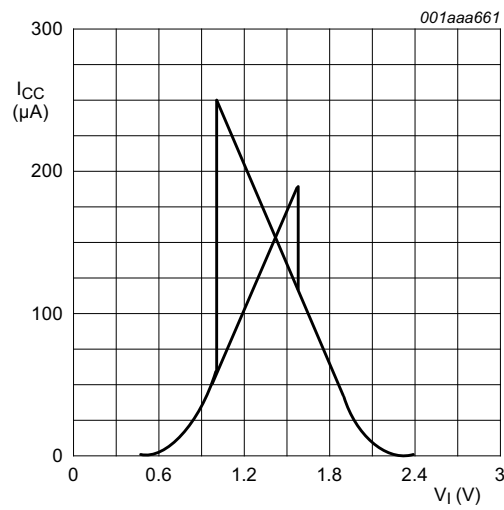

$V_{CC} = 3.0$ V.

Fig 12. Typical 74LV14 transfer characteristics

15. Application information

The slow input rise and fall times cause additional power dissipation, this can be calculated using the following formula:

$$P_{\text{add}} = f_i \times (t_r \times \Delta I_{\text{CC(AV)}} + t_f \times \Delta I_{\text{CC(AV)}}) \times V_{\text{CC}} \text{ where:}$$

P_{add} = additional power dissipation (μW);

f_i = input frequency (MHz);

t_r = rise time (ns); 10 % to 90 %;

t_f = fall time (ns); 90 % to 10 %;

$\Delta I_{\text{CC(AV)}}$ = average additional supply current (μA).

Average $\Delta I_{\text{CC(AV)}}$ differs with positive or negative input transitions, as shown in [Figure 13](#).

An example of a relaxation circuit using the 74LV14 is shown in [Figure 14](#).

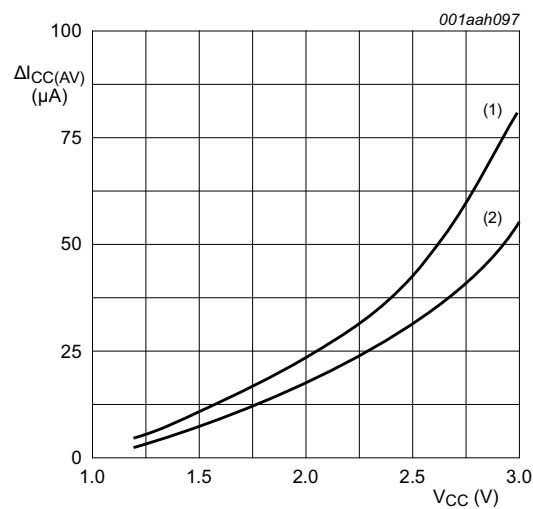

- (1) Positive-going edge.
- (2) Negative-going edge.

Fig 13. Average additional supply current as a function of V_{CC}

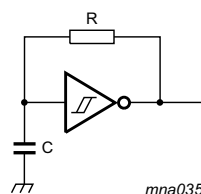

$$f = \frac{1}{T} \approx \frac{1}{0.8 \times RC}$$

Fig 14. Relaxation oscillator

16. Package outline

SO14: plastic small outline package; 14 leads; body width 3.9 mm

SOT108-1

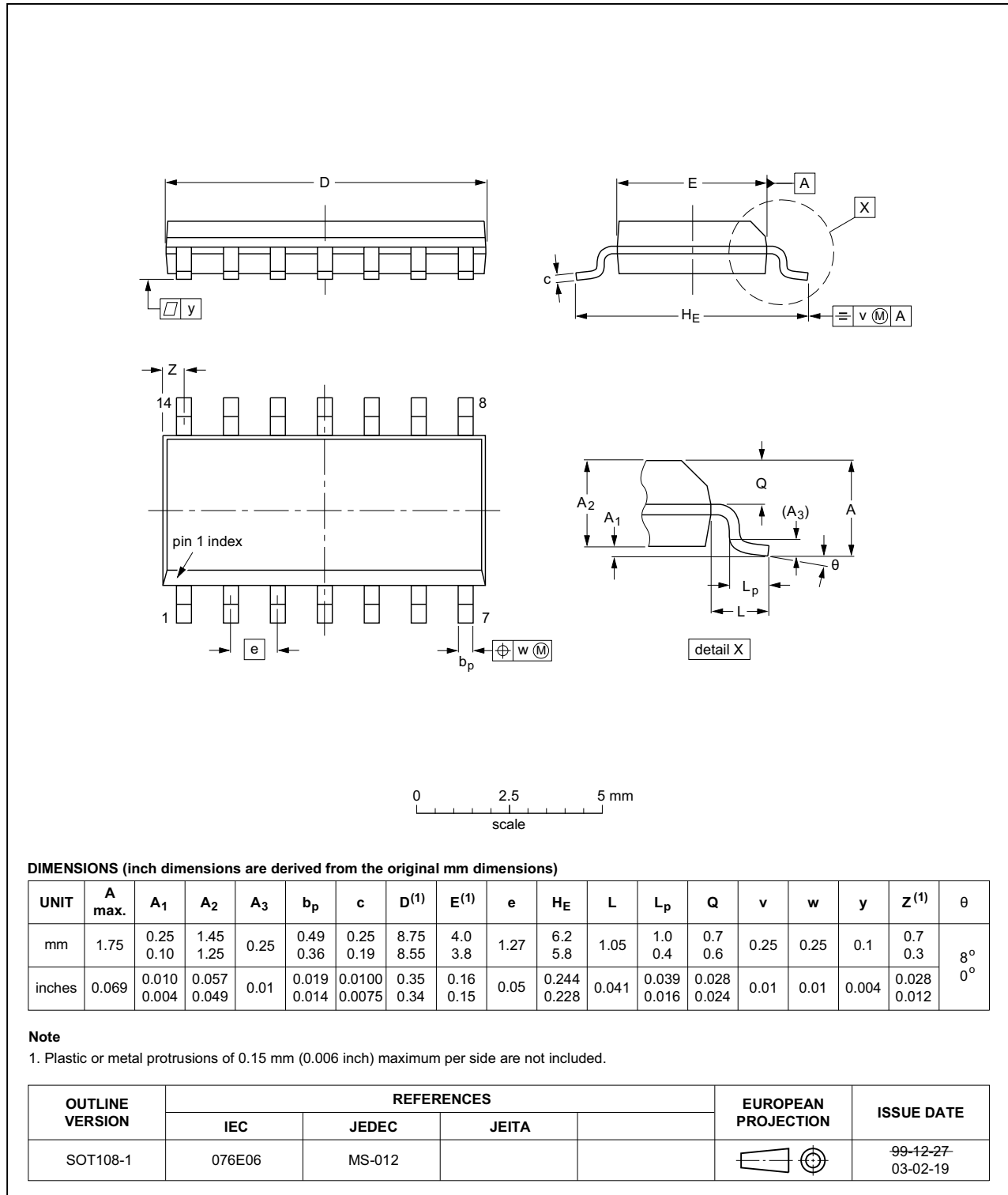

Fig 15. Package outline SOT108-1 (SO14)

SSOP14: plastic shrink small outline package; 14 leads; body width 5.3 mm

SOT337-1

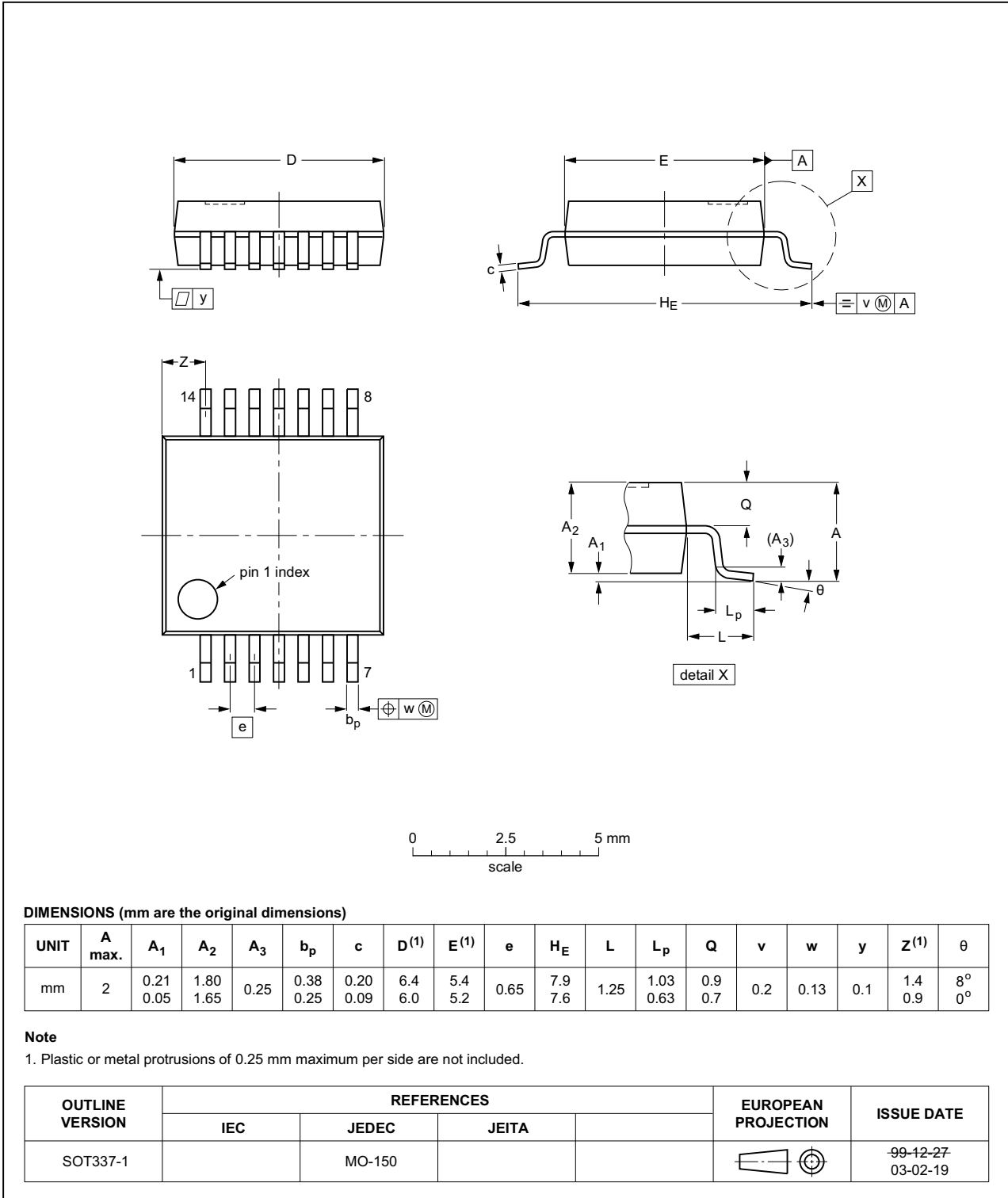

Fig 16. Package outline SOT337-1 (SSOP14)

TSSOP14: plastic thin shrink small outline package; 14 leads; body width 4.4 mm

SOT402-1

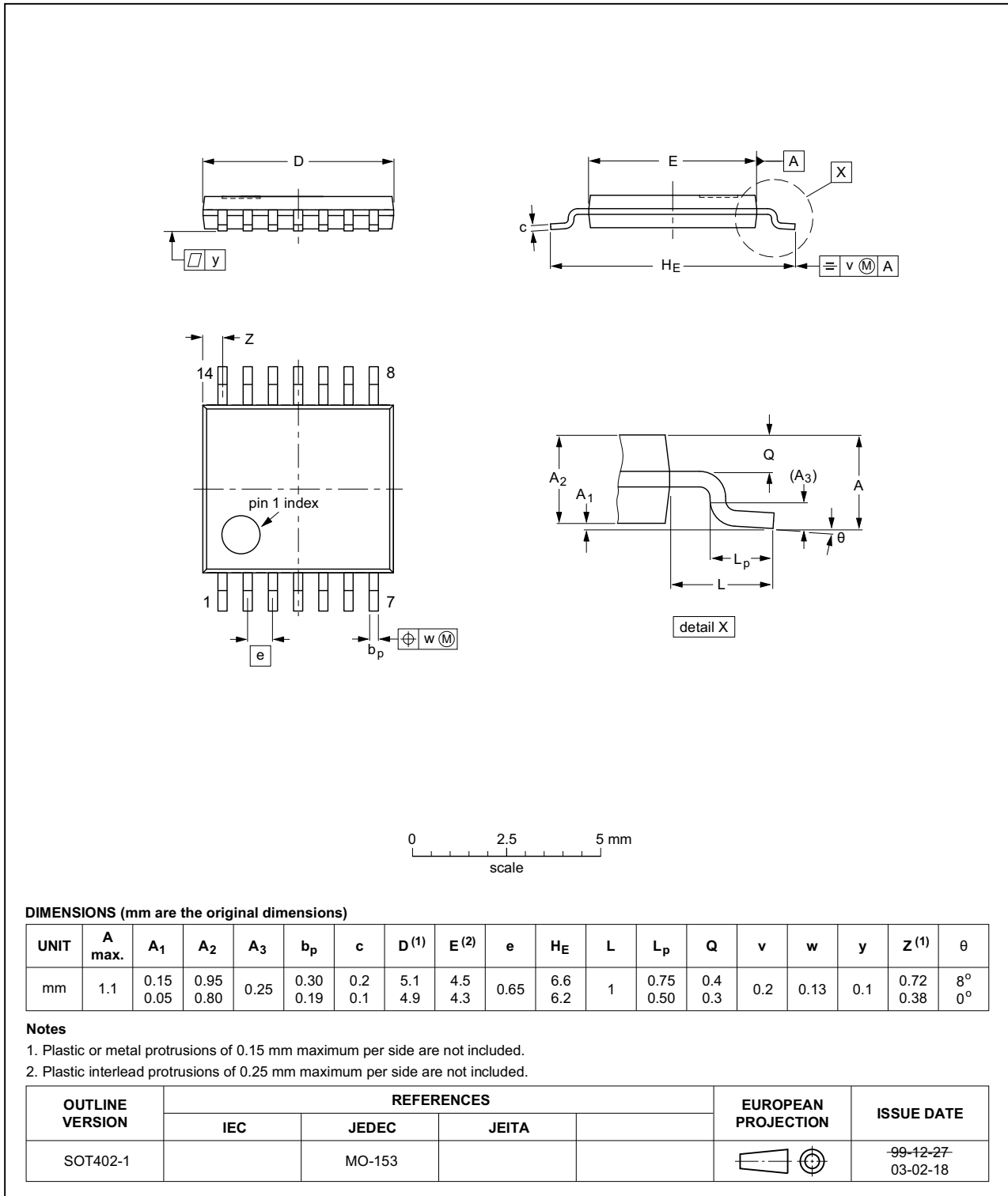

Fig 17. Package outline SOT402-1 (TSSOP14)

DHVQFN14: plastic dual in-line compatible thermal enhanced very thin quad flat package; no leads;
14 terminals; body 2.5 x 3 x 0.85 mm

SOT762-1

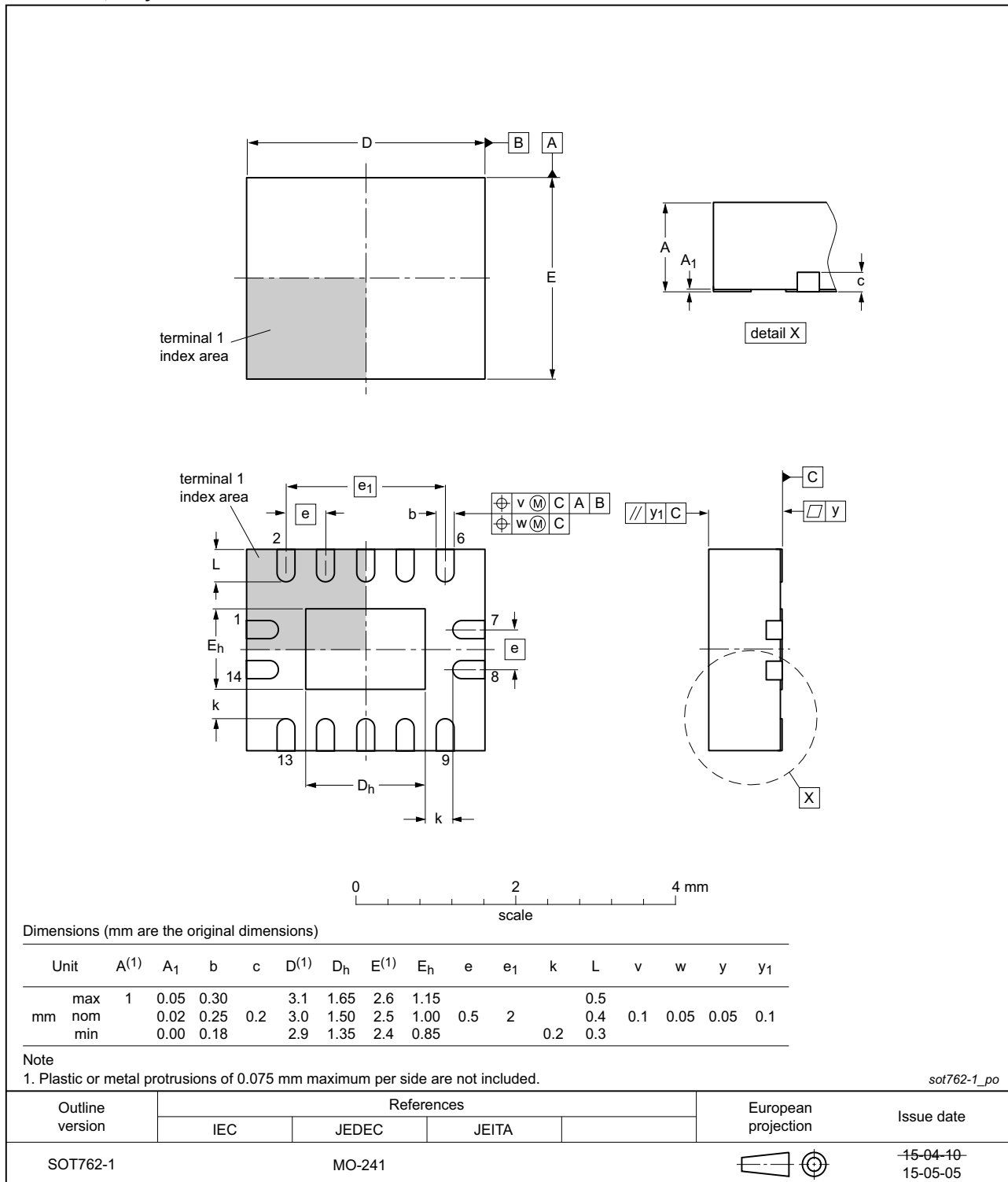

Fig 18. Package outline SOT762-1 (DHVQFN14)

17. Abbreviations

Table 11. Abbreviations

Acronym	Description
CMOS	Complementary Metal Oxide Semiconductor
DUT	Device Under Test
ESD	ElectroStatic Discharge
HBM	Human Body Model
MM	Machine Model
TTL	Transistor-Transistor Logic

18. Revision history

Table 12. Revision history

Document ID	Release date	Data sheet status	Change notice	Supersedes
74LV14 v.7	20151209	Product data sheet	-	74LV14 v.6
Modifications:	<ul style="list-style-type: none"> Type number 74LV14N (SOT27-1) removed. 			
74LV14 v.6	20111212	Product data sheet	-	74LV14 v.5
Modifications:	<ul style="list-style-type: none"> Legal pages updated. 			
74LV14 v.5	20110105	Product data sheet	-	74LV14 v.4
74LV14 v.4	20090702	Product data sheet	-	74LV14 v.3
74LV14 v.3	20071220	Product data sheet	-	74LV14 v.2
74LV14 v.2	19980420	Product specification	-	74LV14 v.1
74LV14 v.1	19970203	Product specification	-	-

19. Legal information

19.1 Data sheet status

Document status ^{[1][2]}	Product status ^[3]	Definition
Objective [short] data sheet	Development	This document contains data from the objective specification for product development.
Preliminary [short] data sheet	Qualification	This document contains data from the preliminary specification.
Product [short] data sheet	Production	This document contains the product specification.

[1] Please consult the most recently issued document before initiating or completing a design.

[2] The term 'short data sheet' is explained in section "Definitions".

[3] The product status of device(s) described in this document may have changed since this document was published and may differ in case of multiple devices. The latest product status information is available on the Internet at URL <http://www.nexperia.com>.

19.2 Definitions

Draft — The document is a draft version only. The content is still under internal review and subject to formal approval, which may result in modifications or additions. Nexperia does not give any representations or warranties as to the accuracy or completeness of information included herein and shall have no liability for the consequences of use of such information.

Short data sheet — A short data sheet is an extract from a full data sheet with the same product type number(s) and title. A short data sheet is intended for quick reference only and should not be relied upon to contain detailed and full information. For detailed and full information see the relevant full data sheet, which is available on request via the local Nexperia sales office. In case of any inconsistency or conflict with the short data sheet, the full data sheet shall prevail.

Product specification — The information and data provided in a Product data sheet shall define the specification of the product as agreed between Nexperia and its customer, unless Nexperia and customer have explicitly agreed otherwise in writing. In no event however, shall an agreement be valid in which the Nexperia product is deemed to offer functions and qualities beyond those described in the Product data sheet.

19.3 Disclaimers

Limited warranty and liability — Information in this document is believed to be accurate and reliable. However, Nexperia does not give any representations or warranties, expressed or implied, as to the accuracy or completeness of such information and shall have no liability for the consequences of use of such information. Nexperia takes no responsibility for the content in this document if provided by an information source outside of Nexperia.

In no event shall Nexperia be liable for any indirect, incidental, punitive, special or consequential damages (including - without limitation - lost profits, lost savings, business interruption, costs related to the removal or replacement of any products or rework charges) whether or not such damages are based on tort (including negligence), warranty, breach of contract or any other legal theory.

Notwithstanding any damages that customer might incur for any reason whatsoever, Nexperia's aggregate and cumulative liability towards customer for the products described herein shall be limited in accordance with the *Terms and conditions of commercial sale* of Nexperia.

Right to make changes — Nexperia reserves the right to make changes to information published in this document, including without limitation specifications and product descriptions, at any time and without notice. This document supersedes and replaces all information supplied prior to the publication hereof.

Suitability for use — Nexperia products are not designed, authorized or warranted to be suitable for use in life support, life-critical or safety-critical systems or equipment, nor in applications where failure or malfunction of a Nexperia product can reasonably be expected to result in personal injury, death or severe property or environmental damage. Nexperia and its suppliers accept no liability for inclusion and/or use of Nexperia products in such equipment or applications and therefore such inclusion and/or use is at the customer's own risk.

Applications — Applications that are described herein for any of these products are for illustrative purposes only. Nexperia makes no representation or warranty that such applications will be suitable for the specified use without further testing or modification.

Customers are responsible for the design and operation of their applications and products using Nexperia products, and Nexperia accepts no liability for any assistance with applications or customer product design. It is customer's sole responsibility to determine whether the Nexperia product is suitable and fit for the customer's applications and products planned, as well as for the planned application and use of customer's third party customer(s). Customers should provide appropriate design and operating safeguards to minimize the risks associated with their applications and products.

Nexperia does not accept any liability related to any default, damage, costs or problem which is based on any weakness or default in the customer's applications or products, or the application or use by customer's third party customer(s). Customer is responsible for doing all necessary testing for the customer's applications and products using Nexperia products in order to avoid a default of the applications and the products or of the application or use by customer's third party customer(s). Nexperia does not accept any liability in this respect.

Limiting values — Stress above one or more limiting values (as defined in the Absolute Maximum Ratings System of IEC 60134) will cause permanent damage to the device. Limiting values are stress ratings only and (proper) operation of the device at these or any other conditions above those given in the Recommended operating conditions section (if present) or the Characteristics sections of this document is not warranted. Constant or repeated exposure to limiting values will permanently and irreversibly affect the quality and reliability of the device.

Terms and conditions of commercial sale — Nexperia products are sold subject to the general terms and conditions of commercial sale, as published at <http://www.nexperia.com/profile/terms>, unless otherwise agreed in a valid written individual agreement. In case an individual agreement is concluded only the terms and conditions of the respective agreement shall apply. Nexperia hereby expressly objects to applying the customer's general terms and conditions with regard to the purchase of Nexperia products by customer.

No offer to sell or license — Nothing in this document may be interpreted or construed as an offer to sell products that is open for acceptance or the grant, conveyance or implication of any license under any copyrights, patents or other industrial or intellectual property rights.

Export control — This document as well as the item(s) described herein may be subject to export control regulations. Export might require a prior authorization from competent authorities.

Non-automotive qualified products — Unless this data sheet expressly states that this specific Nexperia product is automotive qualified, the product is not suitable for automotive use. It is neither qualified nor tested in accordance with automotive testing or application requirements. Nexperia accepts no liability for inclusion and/or use of non-automotive qualified products in automotive equipment or applications.

In the event that customer uses the product for design-in and use in automotive applications to automotive specifications and standards, customer (a) shall use the product without Nexperia's warranty of the product for such automotive applications, use and specifications, and (b) whenever customer uses the product for automotive applications beyond

Nexperia's specifications such use shall be solely at customer's own risk, and (c) customer fully indemnifies Nexperia for any liability, damages or failed product claims resulting from customer design and use of the product for automotive applications beyond Nexperia's standard warranty and Nexperia's product specifications.

Translations — A non-English (translated) version of a document is for reference only. The English version shall prevail in case of any discrepancy between the translated and English versions.

19.4 Trademarks

Notice: All referenced brands, product names, service names and trademarks are the property of their respective owners.

20. Contact information

For more information, please visit: <http://www.nexperia.com>



For sales office addresses, please send an email to: salesaddresses@nexperia.com

21. Contents

1	General description	1
2	Features and benefits	1
3	Applications	1
4	Ordering information	2
5	Functional diagram	2
6	Pinning information	3
6.1	Pinning	3
6.2	Pin description	3
7	Functional description	4
8	Limiting values	4
9	Recommended operating conditions	4
10	Static characteristics	5
11	Dynamic characteristics	6
12	Waveforms	6
13	Transfer characteristics	7
14	Waveforms transfer characteristics	8
15	Application information	10
16	Package outline	11
17	Abbreviations	15
18	Revision history	15
19	Legal information	16
19.1	Data sheet status	16
19.2	Definitions	16
19.3	Disclaimers	16
19.4	Trademarks	17
20	Contact information	17
21	Contents	18

Looking for pricing, stock, or lifecycle information?

Click below to explore more details on WIN SOURCE:

-  [View 74LV14DB,118 on WIN SOURCE](#)
-  [Nexperia USA Inc. Information](#)

Optimize Your Supply Chain with WIN SOURCE Solutions

-  Global Sourcing Solution
-  Obsolete Management
-  Cost Control Management
-  Shortage Management
-  Alternative Solution
-  Excess Inventory Management