



THE DATASHEET OF STGP3NC120HD





STGB3NC120HD STGF3NC120HD, STGP3NC120HD

7 A, 1200 V very fast IGBT with ultrafast diode

Features

- High voltage capability
- High speed
- Very soft ultrafast recovery anti-parallel diode

Applications

- Home appliance
- Lighting

Description

This high voltage and very fast IGBT shows an excellent trade-off between low conduction losses and fast switching performance. It is designed in PowerMESH™ technology combined with high voltage ultrafast diode.

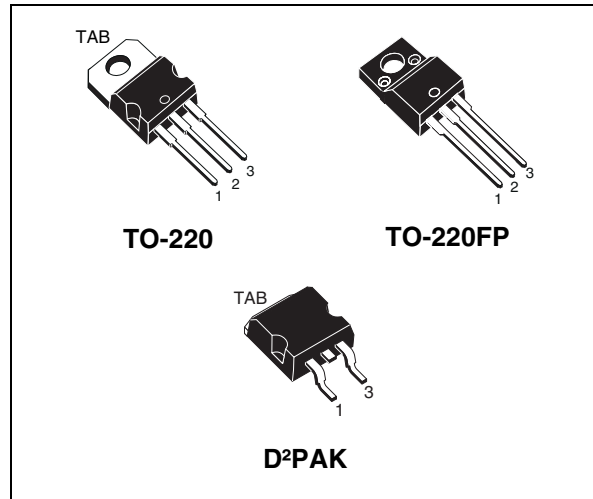

Figure 1. Internal schematic diagram

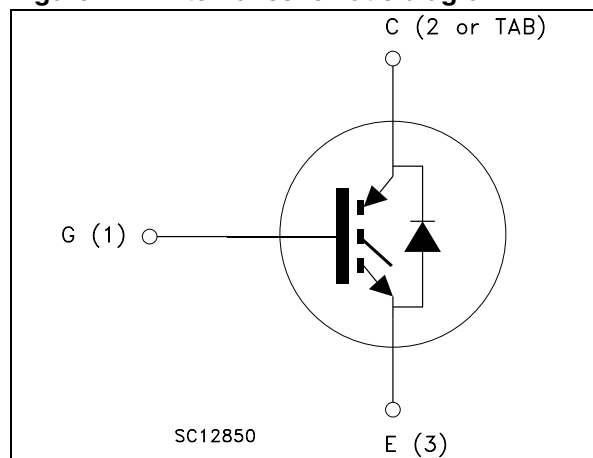

Table 1. Device summary

Order codes	Marking	Packages	Packaging
STGB3NC120HDT4	GB3NC120HD	D ² PAK	Tape and reel
STGF3NC120HD	GF3NC120HD	TO-220FP	Tube
STGP3NC120HD	GP3NC120HD	TO-220	Tube

Contents

1	Electrical ratings	3
2	Electrical characteristics	4
	2.1 Electrical characteristics (curves)	6
3	Test circuit	9
4	Package mechanical data	10
5	Revision history	15

1 Electrical ratings

Table 2. Absolute maximum ratings

Symbol	Parameter	Value		Unit
		TO-220FP	TO-220/D ² PAK	
V _{CES}	Collector-emitter voltage (V _{GE} = 0)	1200		V
I _C ⁽¹⁾	Continuous collector current at T _C = 25 °C	6	14	A
I _C ⁽¹⁾	Continuous collector current at T _C = 100 °C	3	7	A
I _{CL} ⁽²⁾	Turn-off latching current	14		A
I _{CP} ⁽³⁾	Pulsed collector current	20		A
V _{GE}	Gate-emitter voltage	± 20		V
I _F	Diode RMS forward current at T _C = 25 °C	3		A
I _{FSM}	Surge non repetitive forward current t _p =10 ms sinusoidal	12		A
P _{TOT}	Total dissipation at T _C = 25 °C	25	75	W
V _{ISO}	Insulation withstand voltage (RMS) from all three leads to external heat sink	2500		V
T _J	Operating junction temperature	-55 to 150		°C

1. Calculated according to the iterative formula:

$$I_C(T_C) = \frac{T_{j(max)} - T_C}{R_{thj-c} \times V_{CE(sat)(max)}(T_{j(max)}, I_C(T_C))}$$

2. V_{clamp} = 80 % V_{CES}, T_J = 150 °C, R_G = 10 Ω, V_{GE} = 15 V

3. Pulse width limited by maximum junction temperature and turn-off within RBSOA

Table 3. Thermal data

Symbol	Parameter	Value		Unit
		TO-220FP	TO-220/D ² PAK	
R _{thJC}	Thermal resistance junction-case IGBT	5	1.65	°C/W
	Thermal resistance junction-case (diode)	3.5		°C/W
R _{thJA}	Thermal resistance junction-ambient	62.5		°C/W

2 Electrical characteristics

$T_J = 25\text{ °C}$ unless otherwise specified.

Table 4. Static electrical characteristics

Symbol	Parameter	Test conditions	Min.	Typ.	Max.	Unit
$V_{(BR)CES}$	Collector-emitter breakdown voltage ($V_{GE} = 0$)	$I_C = 1\text{ mA}$	1200			V
$V_{CE(sat)}$	Collector-emitter saturation voltage	$V_{GE} = 15\text{ V}, I_C = 3\text{ A}$ $V_{GE} = 15\text{ V}, I_C = 3\text{ A}, T_J = 125\text{ °C}$		2.3 2.2	2.8	V V
$V_{GE(th)}$	Gate threshold voltage	$V_{CE} = V_{GE}, I_C = 250\mu\text{A}$	2		5	V
I_{CES}	Collector cut-off current ($V_{GE} = 0$)	$V_{CE} = 1200\text{ V}$ $V_{CE} = 1200\text{ V}, T_J = 125\text{ °C}$			50 1	μA mA
I_{GES}	Gate-emitter leakage current ($V_{CE} = 0$)	$V_{GE} = \pm 20\text{ V}$			± 100	nA
$g_{fs}^{(1)}$	Forward transconductance	$V_{CE} = 25\text{ V}, I_C = 3\text{ A}$		4		S

1. Pulse duration: 300 μs , duty cycle 1.5%

Table 5. Dynamic

Symbol	Parameter	Test conditions	Min.	Typ.	Max.	Unit
C_{ies}	Input capacitance	$V_{CE} = 25\text{ V}, f = 1\text{ MHz}, V_{GE} = 0$	-	470	-	pF
C_{oes}	Output capacitance			45		pF
C_{res}	Reverse transfer capacitance			6		pF
Q_g	Total gate charge	$V_{CE} = 960\text{ V},$ $I_C = 3\text{ A}, V_{GE} = 15\text{ V}$	-	24	-	nC
Q_{ge}	Gate-emitter charge			3		nC
Q_{gc}	Gate-collector charge			10		nC

Table 6. Switching on/off (inductive load)

Symbol	Parameter	Test conditions	Min.	Typ.	Max.	Unit
$t_{d(on)}$ t_r $(di/dt)_{on}$	Turn-on delay time Current rise time Turn-on current slope	$V_{CC} = 800\text{ V}$, $I_C = 3\text{ A}$ $R_G = 10\ \Omega$, $V_{GE} = 15\text{ V}$, (see Figure 20)	-	15 3.5 880	-	ns ns A/ μ s
$t_{d(on)}$ t_r $(di/dt)_{on}$	Turn-on delay time Current rise time Turn-on current slope	$V_{CC} = 800\text{ V}$, $I_C = 3\text{ A}$ $R_G = 10\ \Omega$, $V_{GE} = 15\text{ V}$, $T_J = 125\text{ }^\circ\text{C}$ (see Figure 20)	-	14.5 4 770	-	ns ns A/ μ s
$t_r(V_{off})$ $t_{d(off)}$ t_f	Off voltage rise time Turn-off delay time Current fall time	$V_{CC} = 800\text{ V}$, $I_C = 3\text{ A}$ $R_G = 10\ \Omega$, $V_{GE} = 15\text{ V}$, (see Figure 20)	-	72 118 250	-	ns ns ns
$t_r(V_{off})$ $t_{d(off)}$ t_f	Off voltage rise time Turn-off delay time Current fall time	$V_{CC} = 800\text{ V}$, $I_C = 3\text{ A}$ $R_G = 10\ \Omega$, $V_{GE} = 15\text{ V}$, $T_J = 125\text{ }^\circ\text{C}$ (see Figure 20)	-	132 210 470	-	ns ns ns

Table 7. Switching energy (inductive load)

Symbol	Parameter	Test conditions	Min.	Typ.	Max.	Unit
$E_{on}^{(1)}$ $E_{off}^{(2)}$ E_{ts}	Turn-on switching losses Turn-off switching losses Total switching losses	$V_{CC} = 800\text{ V}$, $I_C = 3\text{ A}$ $R_G = 10\ \Omega$, $V_{GE} = 15\text{ V}$, (see Figure 20)	-	236 290 526	-	μ J μ J μ J
$E_{on}^{(1)}$ $E_{off}^{(2)}$ E_{ts}	Turn-on switching losses Turn-off switching losses Total switching losses	$V_{CC} = 800\text{ V}$, $I_C = 3\text{ A}$ $R_G = 10\ \Omega$, $V_{GE} = 15\text{ V}$, $T_J = 125\text{ }^\circ\text{C}$ (see Figure 20)	-	360 620 980	-	μ J μ J μ J

1. E_{on} is the turn-on losses when a typical diode is used in the test circuit in figure 2. If the IGBT is offered in a package with a co-pack diode, the co-pack diode is used as external diode. IGBTs & Diode are at the same temperature (25 °C and 125 °C)
2. Turn-off losses include also the tail of the collector current

Table 8. Collector-emitter diode

Symbol	Parameter	Test conditions	Min.	Typ.	Max.	Unit
V_F	Forward on-voltage	$I_F = 1.5\text{ A}$ $I_F = 1.5\text{ A}$, $T_J = 125\text{ }^\circ\text{C}$	-	1.6 1.3	2.0	V V
t_{rr} Q_{rr} I_{rrm}	Reverse recovery time Reverse recovery charge Reverse recovery current	$I_F = 3\text{ A}$, $V_R = 40\text{ V}$, $di/dt = 100\text{ A}/\mu\text{s}$ (see Figure 23)	-	51 85 3.3		ns nC A
t_{rr} Q_{rr} I_{rrm}	Reverse recovery time Reverse recovery charge Reverse recovery current	$I_F = 3\text{ A}$, $V_R = 40\text{ V}$, $T_J = 125\text{ }^\circ\text{C}$, $di/dt = 100\text{ A}/\mu\text{s}$ (see Figure 23)	-	64 133 4.2		ns nC A

2.1 Electrical characteristics (curves)

Figure 2. Output characteristics

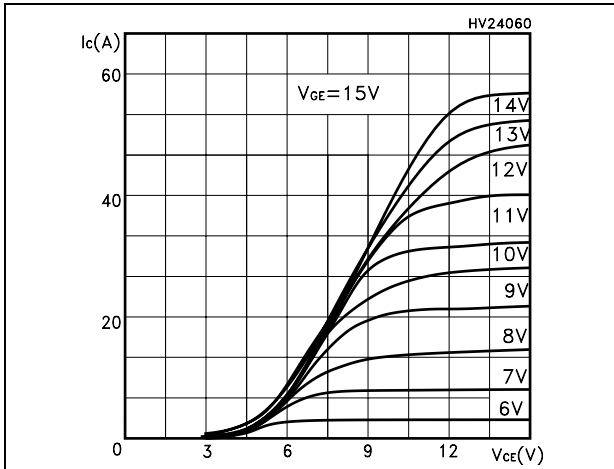

Figure 3. Transfer characteristics

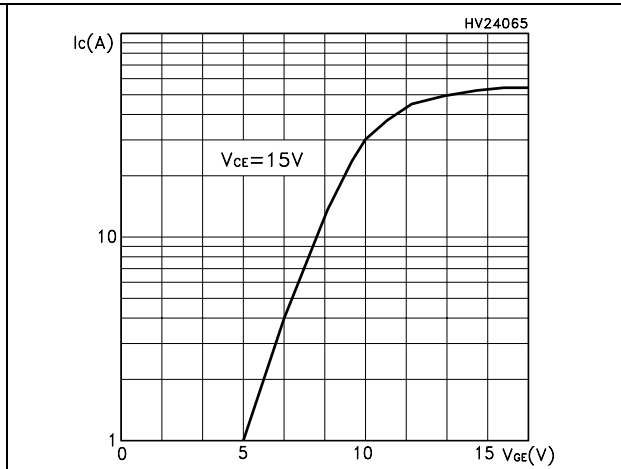

Figure 4. Transconductance

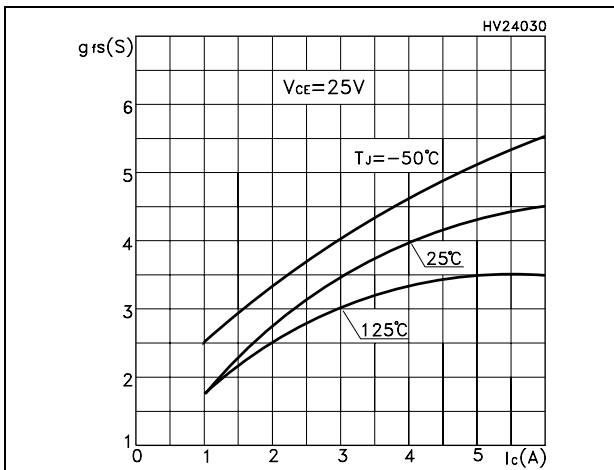

Figure 5. Collector-emitter on voltage vs. temperature

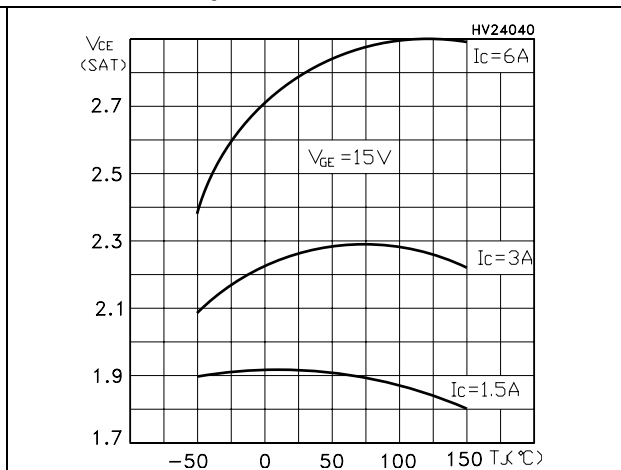

Figure 6. Collector-emitter on voltage vs. collector current

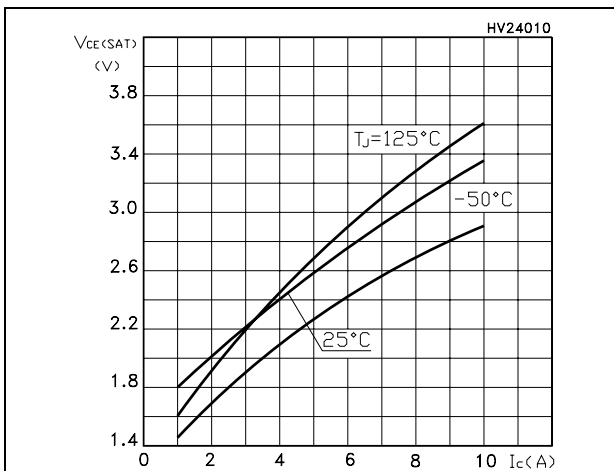

Figure 7. Normalized gate threshold voltage vs. temperature

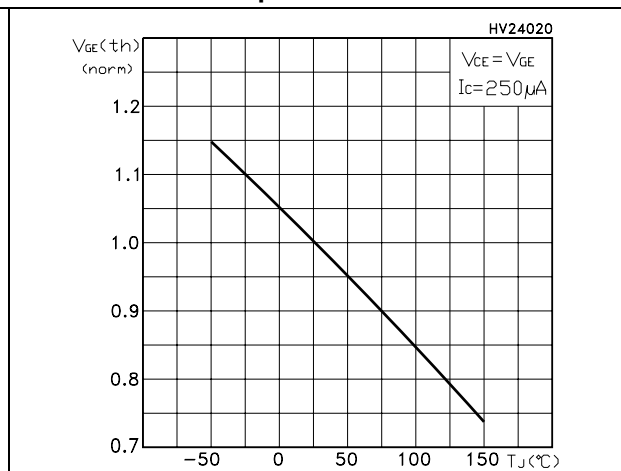

Figure 8. Normalized breakdown voltage vs. temperature

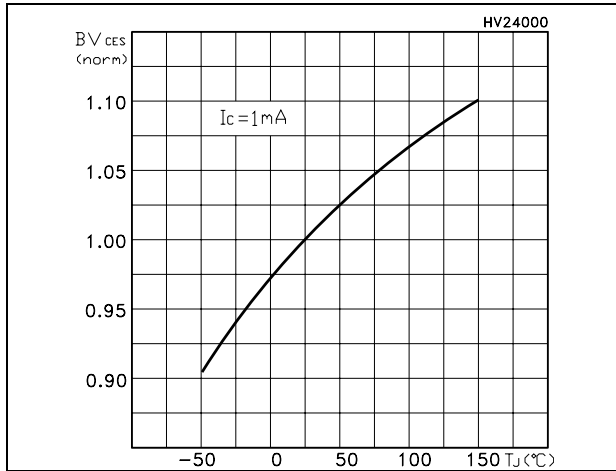

Figure 9. Gate charge vs. gate-source voltage

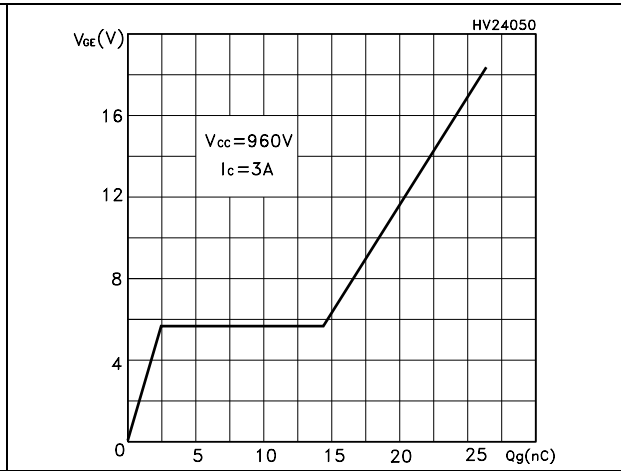

Figure 10. Capacitance variations

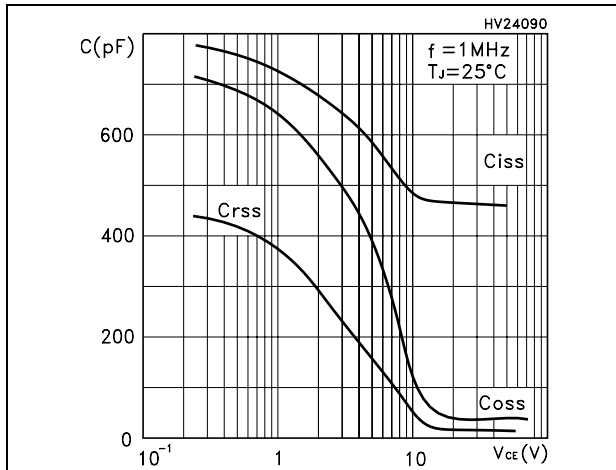

Figure 11. Switching losses vs. temperature

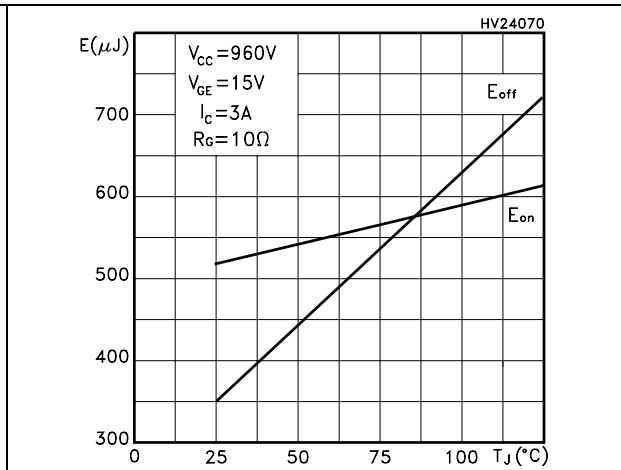

Figure 12. Switching losses vs. gate resistance

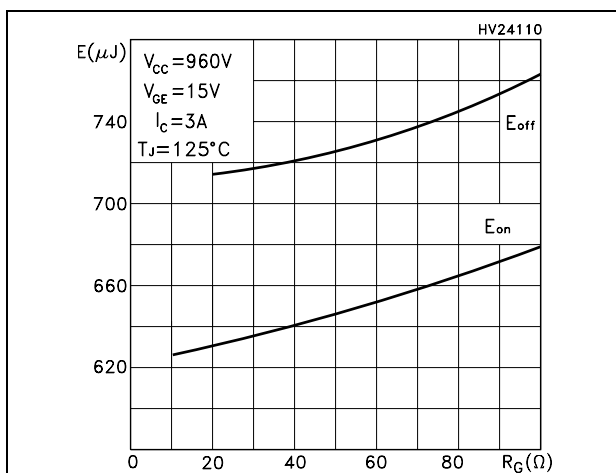

Figure 13. Switching losses vs. collector current

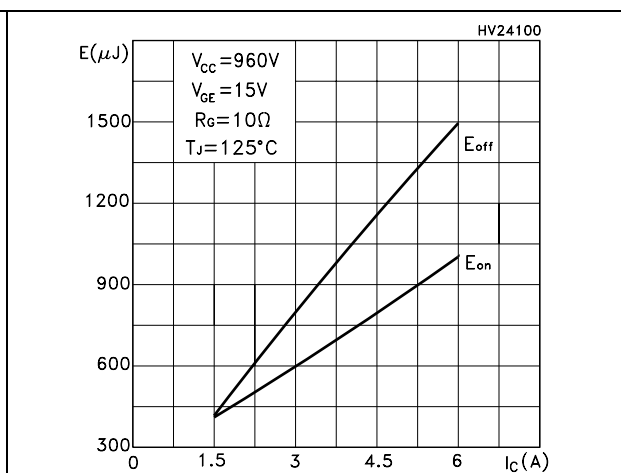

Figure 14. Collector-emitter diode characteristics

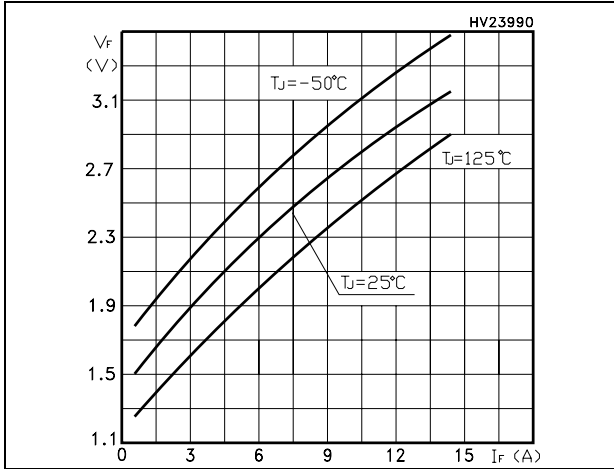

Figure 15. Power losses @ $I_C = 3\text{ A}$

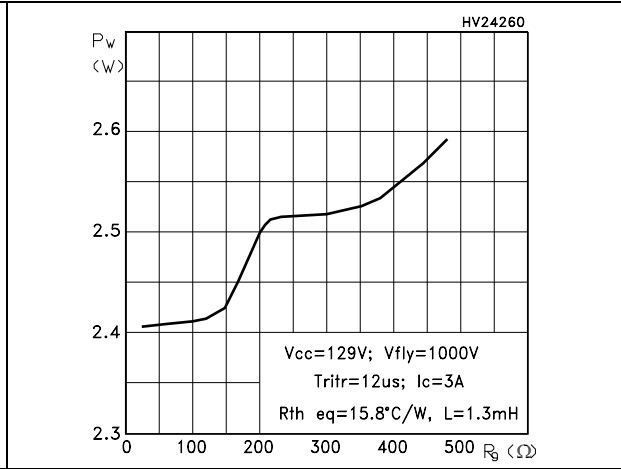

Figure 16. Power losses @ $I_C = 2\text{ A}$

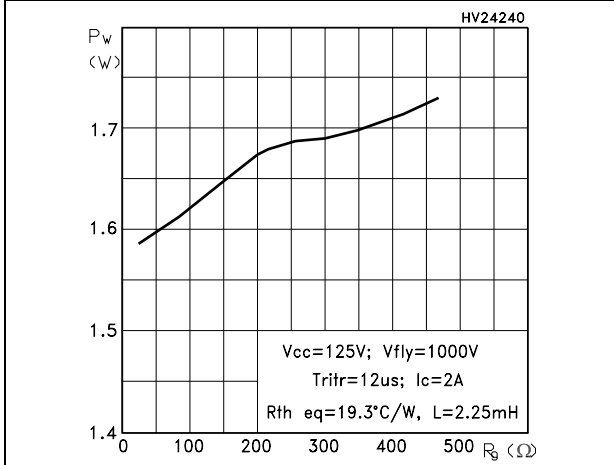

Figure 17. Thermal impedance for TO-220

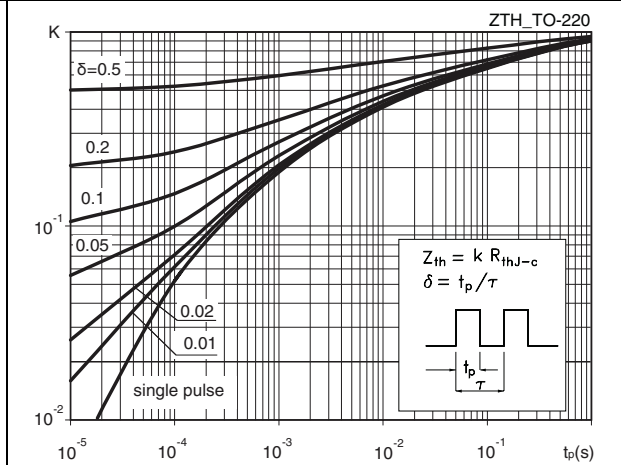

Figure 18. Turn-off SOA

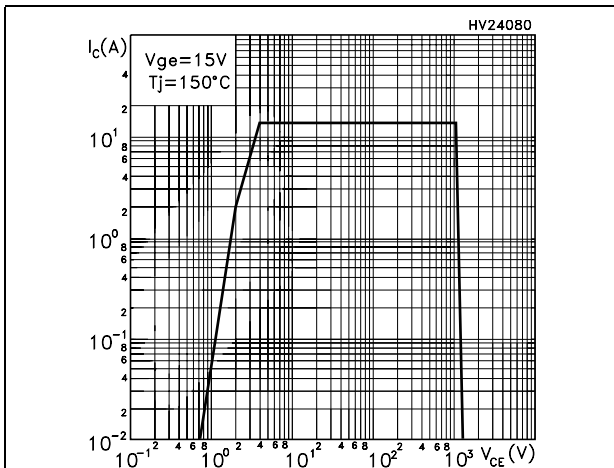
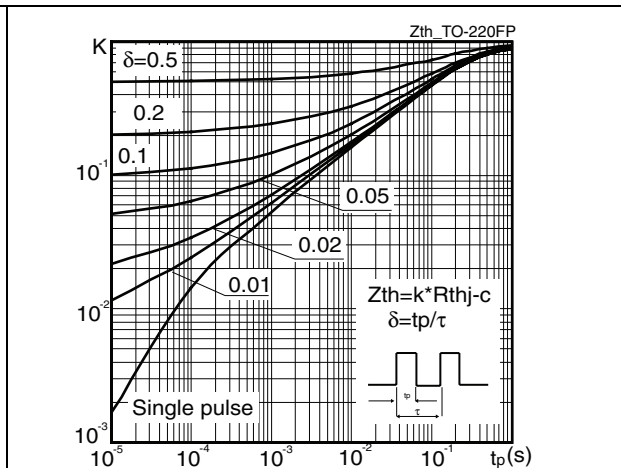

Figure 19. Thermal impedance for TO-220FP



4 Package mechanical data

In order to meet environmental requirements, ST offers these devices in different grades of ECOPACK[®] packages, depending on their level of environmental compliance. ECOPACK[®] specifications, grade definitions and product status are available at: www.st.com. ECOPACK is an ST trademark.

Table 9. D²PAK (TO-263) mechanical data

Dim.	mm		
	Min.	Typ.	Max.
A	4.40		4.60
A1	0.03		0.23
b	0.70		0.93
b2	1.14		1.70
c	0.45		0.60
c2	1.23		1.36
D	8.95		9.35
D1	7.50		
E	10		10.40
E1	8.50		
e		2.54	
e1	4.88		5.28
H	15		15.85
J1	2.49		2.69
L	2.29		2.79
L1	1.27		1.40
L2	1.30		1.75
R		0.4	
V2	0°		8°

D²PAK (TO-263) drawing

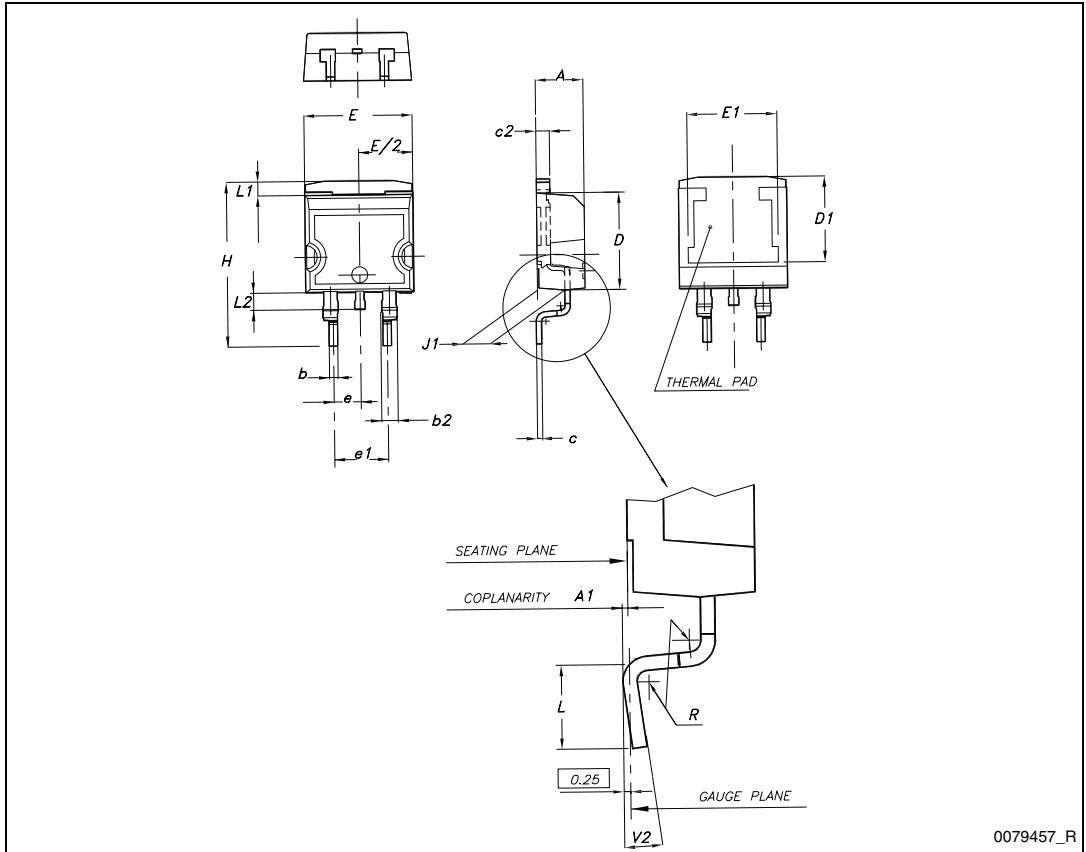

0079457_R

Table 10. TO-220FP mechanical data

Dim.	mm		
	Min.	Typ.	Max.
A	4.4		4.6
B	2.5		2.7
D	2.5		2.75
E	0.45		0.7
F	0.75		1
F1	1.15		1.70
F2	1.15		1.70
G	4.95		5.2
G1	2.4		2.7
H	10		10.4
L2		16	
L3	28.6		30.6
L4	9.8		10.6
L5	2.9		3.6
L6	15.9		16.4
L7	9		9.3
Dia	3		3.2

Figure 24. TO-220FP drawing

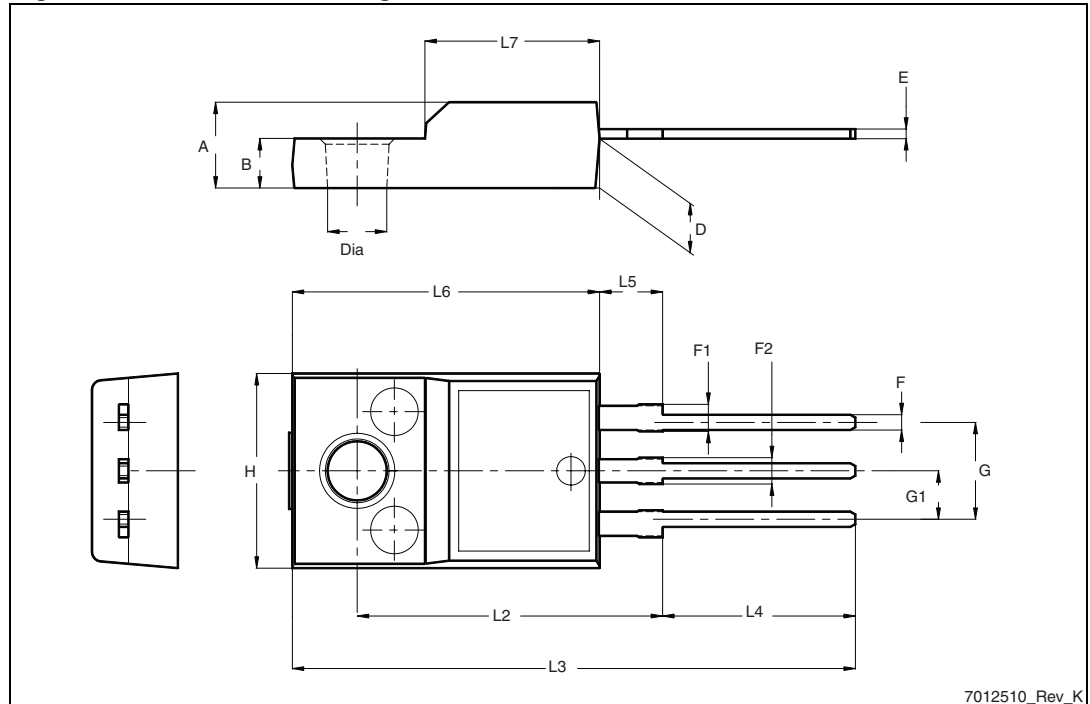

7012510_Rev_K

Table 11. TO-220 type A mechanical data

Dim.	mm		
	Min.	Typ.	Max.
A	4.40		4.60
b	0.61		0.88
b1	1.14		1.70
c	0.48		0.70
D	15.25		15.75
D1		1.27	
E	10		10.40
e	2.40		2.70
e1	4.95		5.15
F	1.23		1.32
H1	6.20		6.60
J1	2.40		2.72
L	13		14
L1	3.50		3.93
L20		16.40	
L30		28.90	
ØP	3.75		3.85
Q	2.65		2.95

TO-220 type A drawing

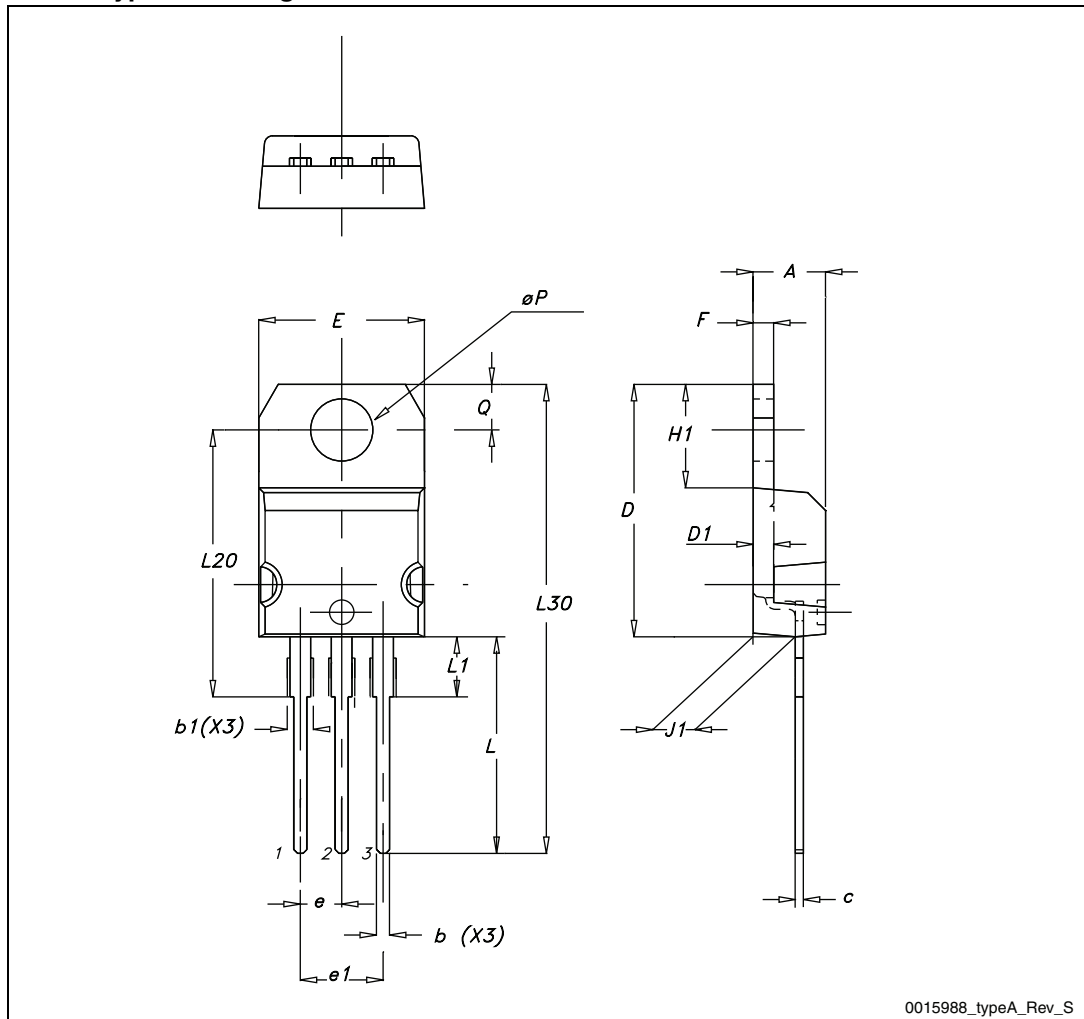

5 Revision history

Table 12. Document revision history

Date	Revision	Changes
13-Dec-2004	1	First release.
21-Jan-2005	2	Modified Figure 18: Turn-off SOA .
03-May-2010	3	Added new package, mechanical data: TO-220.
25-Jan-2011	4	Added new package, mechanical data: D ² PAK.

Please Read Carefully:

Information in this document is provided solely in connection with ST products. STMicroelectronics NV and its subsidiaries ("ST") reserve the right to make changes, corrections, modifications or improvements, to this document, and the products and services described herein at any time, without notice.

All ST products are sold pursuant to ST's terms and conditions of sale.

Purchasers are solely responsible for the choice, selection and use of the ST products and services described herein, and ST assumes no liability whatsoever relating to the choice, selection or use of the ST products and services described herein.

No license, express or implied, by estoppel or otherwise, to any intellectual property rights is granted under this document. If any part of this document refers to any third party products or services it shall not be deemed a license grant by ST for the use of such third party products or services, or any intellectual property contained therein or considered as a warranty covering the use in any manner whatsoever of such third party products or services or any intellectual property contained therein.

UNLESS OTHERWISE SET FORTH IN ST'S TERMS AND CONDITIONS OF SALE ST DISCLAIMS ANY EXPRESS OR IMPLIED WARRANTY WITH RESPECT TO THE USE AND/OR SALE OF ST PRODUCTS INCLUDING WITHOUT LIMITATION IMPLIED WARRANTIES OF MERCHANTABILITY, FITNESS FOR A PARTICULAR PURPOSE (AND THEIR EQUIVALENTS UNDER THE LAWS OF ANY JURISDICTION), OR INFRINGEMENT OF ANY PATENT, COPYRIGHT OR OTHER INTELLECTUAL PROPERTY RIGHT.

UNLESS EXPRESSLY APPROVED IN WRITING BY AN AUTHORIZED ST REPRESENTATIVE, ST PRODUCTS ARE NOT RECOMMENDED, AUTHORIZED OR WARRANTED FOR USE IN MILITARY, AIR CRAFT, SPACE, LIFE SAVING, OR LIFE SUSTAINING APPLICATIONS, NOR IN PRODUCTS OR SYSTEMS WHERE FAILURE OR MALFUNCTION MAY RESULT IN PERSONAL INJURY, DEATH, OR SEVERE PROPERTY OR ENVIRONMENTAL DAMAGE. ST PRODUCTS WHICH ARE NOT SPECIFIED AS "AUTOMOTIVE GRADE" MAY ONLY BE USED IN AUTOMOTIVE APPLICATIONS AT USER'S OWN RISK.

Resale of ST products with provisions different from the statements and/or technical features set forth in this document shall immediately void any warranty granted by ST for the ST product or service described herein and shall not create or extend in any manner whatsoever, any liability of ST.

ST and the ST logo are trademarks or registered trademarks of ST in various countries.

Information in this document supersedes and replaces all information previously supplied.

The ST logo is a registered trademark of STMicroelectronics. All other names are the property of their respective owners.

© 2011 STMicroelectronics - All rights reserved



STMicroelectronics group of companies

Australia - Belgium - Brazil - Canada - China - Czech Republic - Finland - France - Germany - Hong Kong - India - Israel - Italy - Japan - Malaysia - Malta - Morocco - Philippines - Singapore - Spain - Sweden - Switzerland - United Kingdom - United States of America

www.st.com

Looking for pricing, stock, or lifecycle information?

Click below to explore more details on WIN SOURCE:

-  [View STGP3NC120HD](#) on WIN SOURCE
-  [STMicroelectronics](#) Information

Optimize Your Supply Chain with WIN SOURCE Solutions

-  Global Sourcing Solution
-  Obsolete Management
-  Cost Control Management
-  Shortage Management
-  Alternative Solution
-  Excess Inventory Management