



# THE DATASHEET OF STGFL6NC60DI





# STGBL6NC60DI, STGDL6NC60DI STGFL6NC60DI, STGPL6NC60DI

6 A, 600 V hyper fast IGBT

## Features

- Low  $C_{RES} / C_{IES}$  ratio (no cross-conduction susceptibility)
- Very high frequency operation
- Very soft ultrafast recovery antiparallel diode

## Applications

- High frequency inverters
- SMPS and PFC (hard switching too)
- High frequency motor drive

## Description

Thanks to a new lifetime control system, this new PowerMESH™ technology-based series of devices exhibits very low turn-off energy, representing the best trade-off between on-state voltage and switching losses and thus allowing very high operating frequencies.

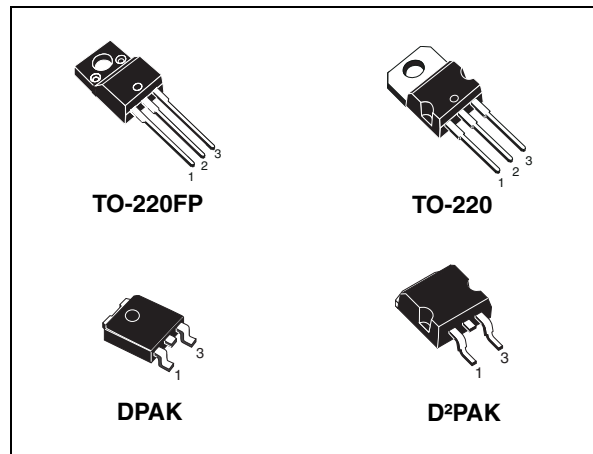

Figure 1. Internal schematic diagram

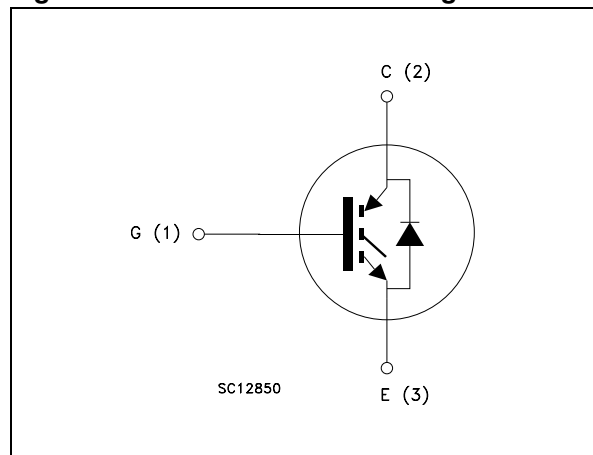

Table 1. Device summary

Order codes	Marking	Package	Packaging
STGBL6NC60DIT4	GBL6NC60DI	D <sup>2</sup> PAK	Tape and reel
STGDL6NC60DIT4	GDL6NC60DI	DPAK	Tape and reel
STGPL6NC60DI	GPL6NC60DI	TO-220	Tube
STGFL6NC60DI	GFL6NC60DI	TO-220FP	Tube

## Contents

<b>1</b>	<b>Electrical ratings</b> .....	<b>3</b>
<b>2</b>	<b>Electrical characteristics</b> .....	<b>4</b>
	2.1 Electrical characteristics (curves) .....	6
<b>3</b>	<b>Test circuits</b> .....	<b>9</b>
<b>4</b>	<b>Package mechanical data</b> .....	<b>10</b>
<b>5</b>	<b>Packaging mechanical data</b> .....	<b>15</b>
<b>6</b>	<b>Revision history</b> .....	<b>17</b>

# 1 Electrical ratings

**Table 2. Absolute maximum ratings**

Symbol	Parameter	Value			Unit
		DPAK	TO-220 D <sup>2</sup> PAK	TO-220FP	
V <sub>CES</sub>	Collector-emitter voltage (V <sub>GE</sub> = 0)	600			V
I <sub>C</sub> <sup>(1)</sup>	Collector current (continuous) at T <sub>C</sub> = 25 °C	13	14	7	A
I <sub>C</sub> <sup>(1)</sup>	Collector current (continuous) at T <sub>C</sub> = 100 °C	5	6	3	A
I <sub>CL</sub> <sup>(2)</sup>	Turn-off latching current	18			A
I <sub>CP</sub> <sup>(3)</sup>	Pulsed collector current	18			A
V <sub>GE</sub>	Gate-emitter voltage	±20			V
I <sub>F</sub>	Diode RMS forward current at T <sub>C</sub> = 25 °C	10			A
I <sub>FSM</sub>	Surge non repetitive forward current t <sub>p</sub> =10ms sinusoidal	25			A
P <sub>TOT</sub>	Total dissipation at T <sub>C</sub> = 25 °C	50	56	22	W
V <sub>ISO</sub>	Isolation withstand voltage (RMS) from all three leads to external heat sink (t=1 s; T <sub>C</sub> =25 °C)	--	--	2500	V
T <sub>j</sub>	Operating junction temperature	- 55 to 150			°C

1. Calculated according to the iterative formula:

$$I_C(T_C) = \frac{T_{j(max)} - T_C}{R_{thj-c} \times V_{CE(sat)(max)}(T_{j(max)}, I_C(T_C))}$$

2. V<sub>clamp</sub> = 80%.(V<sub>CES</sub>), T<sub>j</sub> = 150°C, R<sub>G</sub> = 10 Ω, V<sub>GE</sub> = 15 V

3. Pulse width limited by maximum junction temperature and turn-off within RBSOA

**Table 3. Thermal data**

Symbol	Parameter	Value			Unit
		DPAK	TO-220 D <sup>2</sup> PAK	TO-220FP	
R <sub>thj-case</sub>	Thermal resistance junction-case IGBT max.	2.5	2.2	5.6	°C/W
	Thermal resistance junction-case diode max.	4.5	4	7	°C/W
R <sub>thj-amb</sub>	Thermal resistance junction-ambient max.	100	62.5		°C/W

## 2 Electrical characteristics

( $T_j=25\text{ °C}$  unless otherwise specified)

**Table 4. Static electrical characteristics**

Symbol	Parameter	Test conditions	Min.	Typ.	Max.	Unit
$V_{(BR)CES}$	Collector-emitter breakdown voltage ( $V_{GE} = 0$ )	$I_C = 1\text{ mA}$	600			V
$V_{CE(sat)}$	Collector-emitter saturation voltage	$V_{GE} = 15\text{ V}, I_C = 1.5\text{ A}$		1.9		V
		$V_{GE} = 15\text{ V}, I_C = 3\text{ A}$		2.2	2.9	V
		$V_{GE} = 15\text{ V}, I_C = 3\text{ A}, T_j = 125\text{ °C}$		2		V
$V_{GE(th)}$	Gate threshold voltage	$V_{CE} = V_{GE}, I_C = 250\text{ }\mu\text{A}$	3.75		5.75	V
$I_{CES}$	Collector cut-off current ( $V_{GE} = 0$ )	$V_{CE} = 600\text{ V}$			50	$\mu\text{A}$
		$V_{CE} = 600\text{ V}, T_j = 125\text{ °C}$			5	mA
$I_{GES}$	Gate-emitter leakage current ( $V_{CE} = 0$ )	$V_{GE} = \pm 20\text{ V}$			$\pm 100$	nA
$g_{fs}$	Forward transconductance	$V_{CE} = 15\text{ V}, I_C = 3\text{ A}$		3		S

**Table 5. Dynamic electrical characteristics**

Symbol	Parameter	Test conditions	Min.	Typ.	Max.	Unit
$C_{ies}$ $C_{oes}$ $C_{res}$	Input capacitance	$V_{CE} = 25\text{ V}, f = 1\text{ MHz},$ $V_{GE} = 0$	-	208	-	pF
	Output capacitance			32.5		
	Reverse transfer capacitance			5.4		
$Q_g$ $Q_{ge}$ $Q_{gc}$	Total gate charge	$V_{CE} = 390\text{ V}, I_C = 3\text{ A},$ $V_{GE} = 15\text{ V}$ (see Figure 17)	-	12	-	nC
	Gate-emitter charge			2.6		nC
	Gate-collector charge			4.9		nC

**Table 6. Switching on/off (inductive load)**

Symbol	Parameter	Test conditions	Min.	Typ.	Max.	Unit
$t_{d(on)}$ $t_r$ $(di/dt)_{on}$	Turn-on delay time Current rise time Turn-on current slope	$V_{CC} = 390\text{ V}$ , $I_C = 3\text{ A}$ $R_G = 10\ \Omega$ , $V_{GE} = 15\text{ V}$ (see Figure 18)	-	6.7 3.7 930	-	ns ns A/ $\mu$ s
$t_{d(on)}$ $t_r$ $(di/dt)_{on}$	Turn-on delay time Current rise time Turn-on current slope	$V_{CC} = 390\text{ V}$ , $I_C = 3\text{ A}$ $R_G = 10\ \Omega$ , $V_{GE} = 15\text{ V}$ , $T_j = 125\text{ }^\circ\text{C}$ (see Figure 18)	-	6.5 4 820	-	ns ns A/ $\mu$ s
$t_r(V_{off})$ $t_{d(off)}$ $t_f$	Off voltage rise time Turn-off delay time Current fall time	$V_{CC} = 390\text{ V}$ , $I_C = 3\text{ A}$ , $R_{GE} = 10\ \Omega$ , $V_{GE} = 15\text{ V}$ (see Figure 18)	-	17 46 47	-	ns ns ns
$t_r(V_{off})$ $t_{d(off)}$ $t_f$	Off voltage rise time Turn-off delay time Current fall time	$V_{CC} = 390\text{ V}$ , $I_C = 3\text{ A}$ , $R_{GE} = 10\ \Omega$ , $V_{GE} = 15\text{ V}$ , $T_j = 125\text{ }^\circ\text{C}$ (see Figure 18)	-	35 67 55	-	ns ns ns

**Table 7. Switching energy (inductive load)**

Symbol	Parameter	Test conditions	Min.	Typ.	Max.	Unit
$E_{on}^{(1)}$ $E_{off}^{(2)}$ $E_{ts}$	Turn-on switching losses Turn-off switching losses Total switching losses	$V_{CC} = 390\text{ V}$ , $I_C = 3\text{ A}$ $R_G = 10\ \Omega$ , $V_{GE} = 15\text{ V}$ (see Figure 18)	-	32 24 56	-	$\mu$ J $\mu$ J $\mu$ J
$E_{on}^{(1)}$ $E_{off}^{(2)}$ $E_{ts}$	Turn-on switching losses Turn-off switching losses Total switching losses	$V_{CC} = 390\text{ V}$ , $I_C = 3\text{ A}$ $R_G = 10\ \Omega$ , $V_{GE} = 15\text{ V}$ , $T_j = 125\text{ }^\circ\text{C}$ (see Figure 18)	-	51 46 97	-	$\mu$ J $\mu$ J $\mu$ J

1.  $E_{on}$  is the turn-on losses when a typical diode is used in the test circuit in (see Figure 19). If the IGBT is offered in a package with a co-pak diode, the co-pak diode is used as external diode. IGBTs and diode are at the same temperature (25°C and 125°C)
2. Turn-off losses include also the tail of the collector current

**Table 8. Collector-emitter diode**

Symbol	Parameter	Test conditions	Min.	Typ.	Max.	Unit
$V_F$	Forward on-voltage	$I_F = 1\text{ A}$ $I_F = 3\text{ A}$ $I_F = 3\text{ A}$ , $T_j = 125\text{ }^\circ\text{C}$	-	1.8 1.3	1.7	V V V
$t_{rr}$ $Q_{rr}$ $I_{rrm}$	Reverse recovery time Reverse recovery charge Reverse recovery current	$I_F = 3\text{ A}$ , $V_R = 40\text{ V}$ , $di/dt = 100\text{ A}/\mu\text{s}$ (see Figure 19)	-	23 21 1.5		ns nC A
$t_{rr}$ $Q_{rr}$ $I_{rrm}$	Reverse recovery time Reverse recovery charge Reverse recovery current	$I_F = 3\text{ A}$ , $V_R = 40\text{ V}$ , $T_j = 125\text{ }^\circ\text{C}$ , $di/dt = 100\text{ A}/\mu\text{s}$ (see Figure 19)	-	47 51 2		ns nC A

## 2.1 Electrical characteristics (curves)

Figure 2. Output characteristics

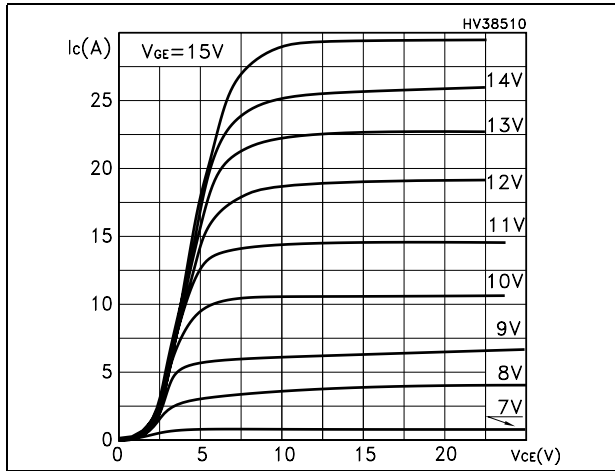

Figure 3. Transfer characteristics

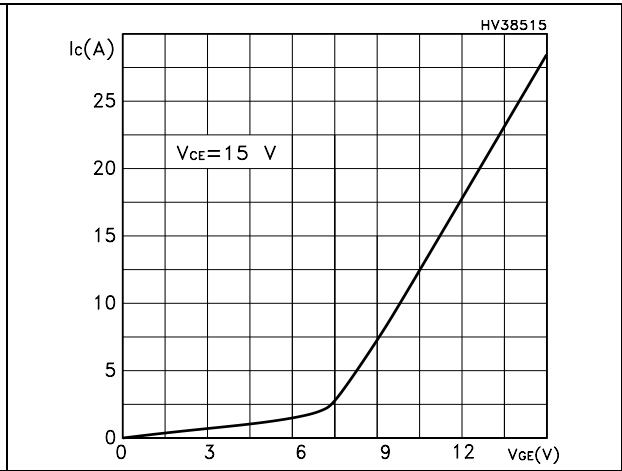

Figure 4. Transconductance

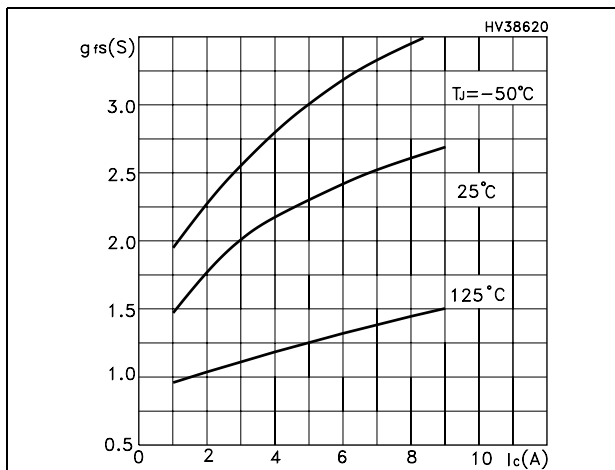

Figure 5. Collector-emitter on voltage vs temperature

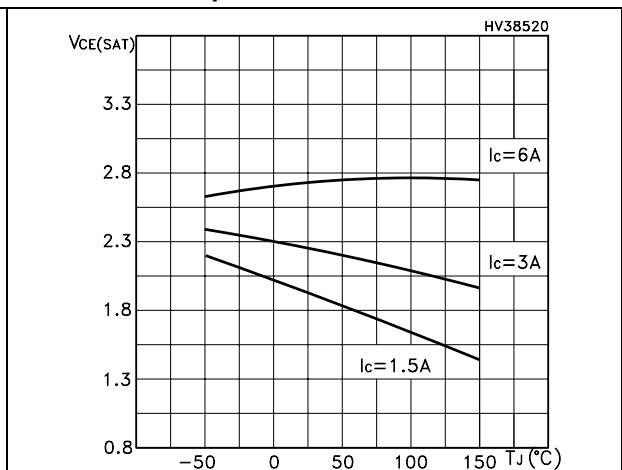

Figure 6. Gate charge vs gate-source voltage

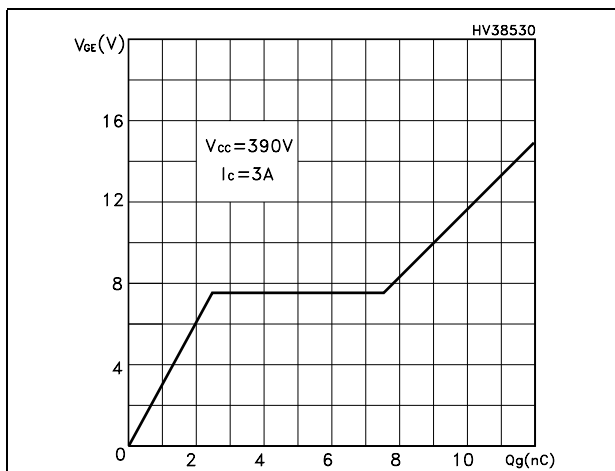

Figure 7. Capacitance variations

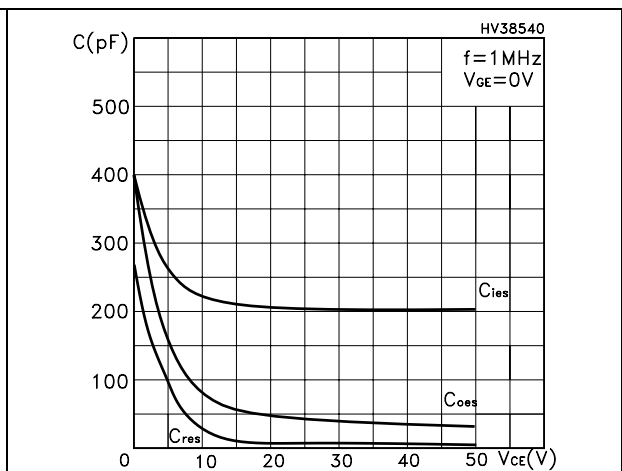

Figure 8. Normalized gate threshold voltage vs temperature

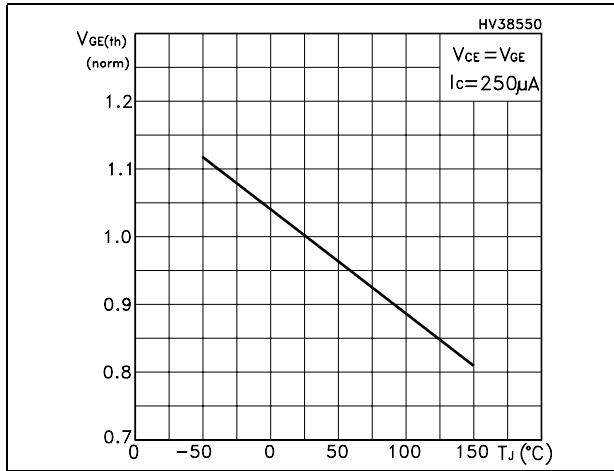

Figure 9. Collector-emitter on voltage vs collector current

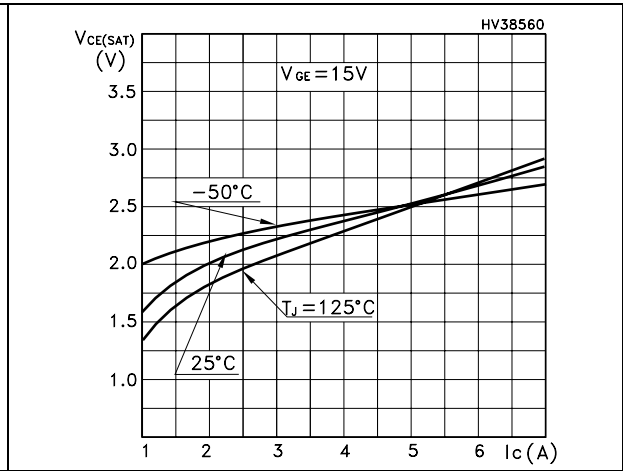

Figure 10. Normalized breakdown voltage vs temperature

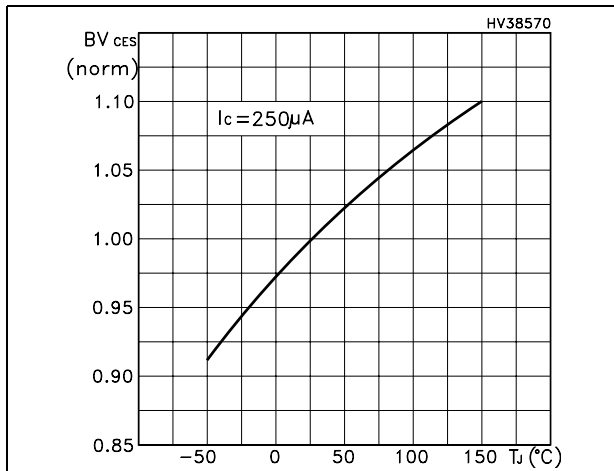

Figure 11. Switching losses vs temperature

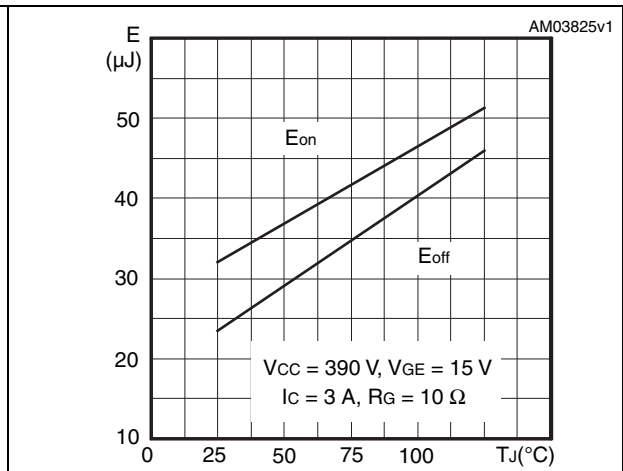

Figure 12. Switching losses vs gate resistance

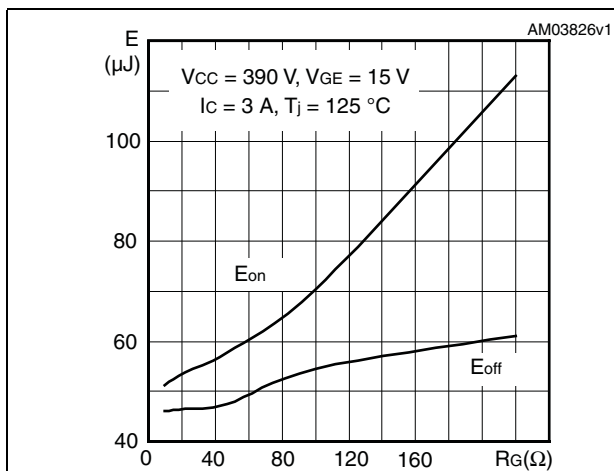

Figure 13. Switching losses vs collector current

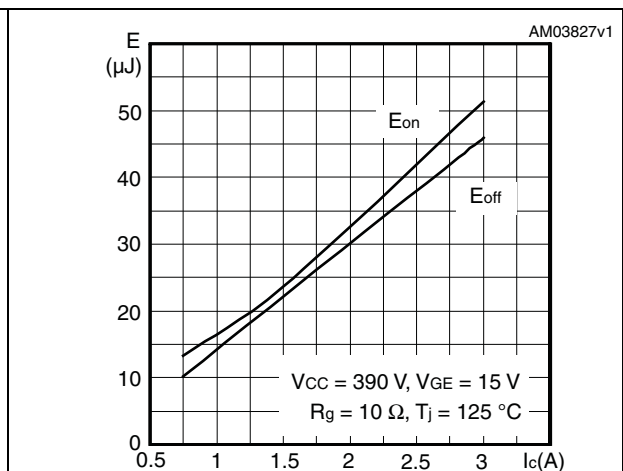

Figure 14. RBSOA

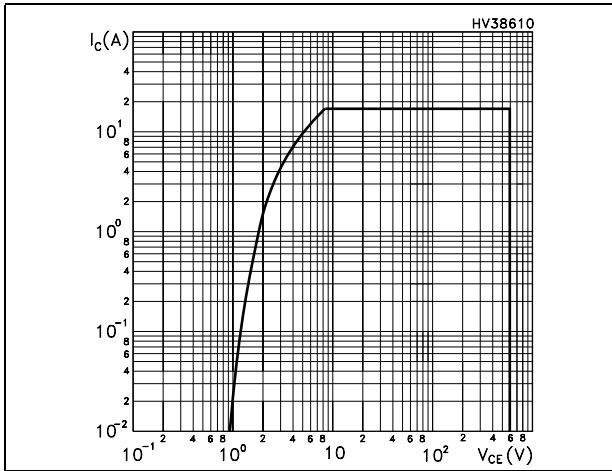
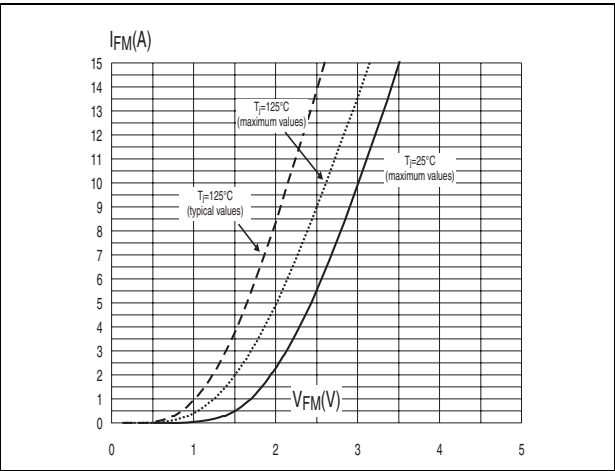

Figure 15. Forward voltage drop versus forward current





## 4      **Package mechanical data**

In order to meet environmental requirements, ST offers these devices in different grades of ECOPACK® packages, depending on their level of environmental compliance. ECOPACK® specifications, grade definitions and product status are available at: [www.st.com](http://www.st.com). ECOPACK® is an ST trademark.

**TO-220 type A mechanical data**

Dim	mm		
	Min	Typ	Max
A	4.40		4.60
b	0.61		0.88
b1	1.14		1.70
c	0.48		0.70
D	15.25		15.75
D1		1.27	
E	10		10.40
e	2.40		2.70
e1	4.95		5.15
F	1.23		1.32
H1	6.20		6.60
J1	2.40		2.72
L	13		14
L1	3.50		3.93
L20		16.40	
L30		28.90	
∅P	3.75		3.85
Q	2.65		2.95

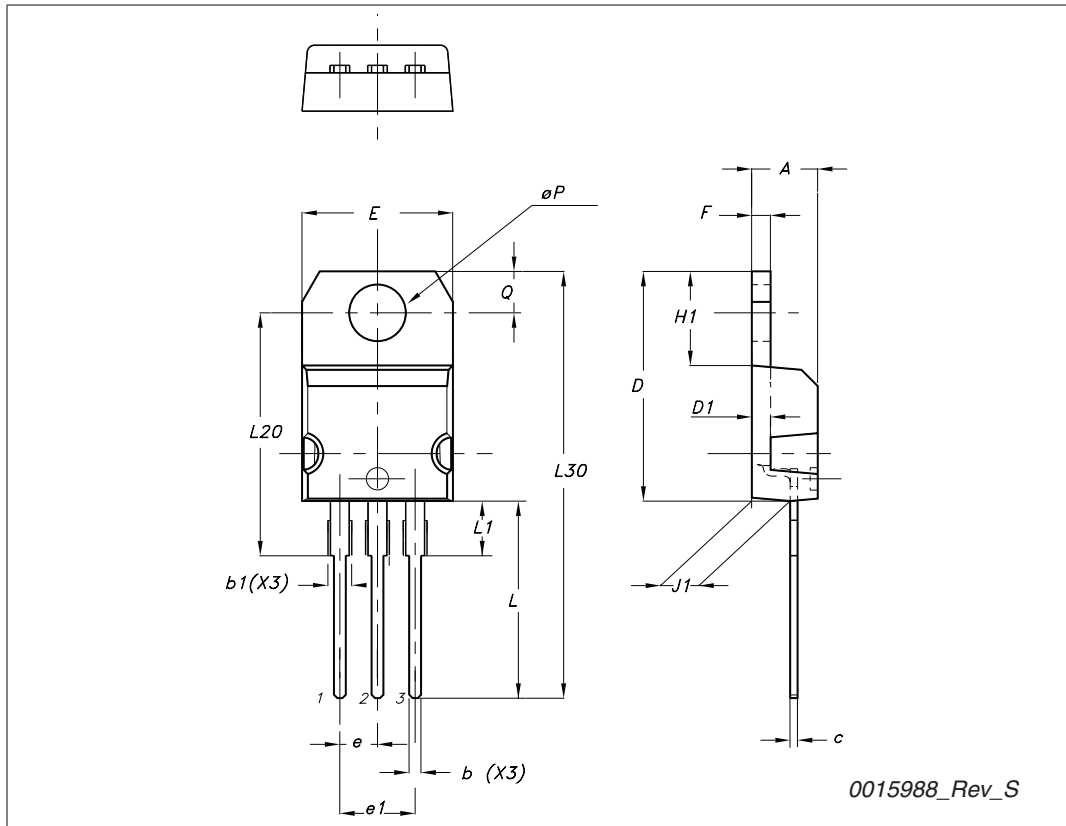

TO-220FP mechanical data

Dim.	mm		
	Min.	Typ.	Max.
A	4.4		4.6
B	2.5		2.7
D	2.5		2.75
E	0.45		0.7
F	0.75		1
F1	1.15		1.70
F2	1.15		1.5
G	4.95		5.2
G1	2.4		2.7
H	10		10.4
L2		16	
L3	28.6		30.6
L4	9.8		10.6
L5	2.9		3.6
L6	15.9		16.4
L7	9		9.3
Dia	3		3.2

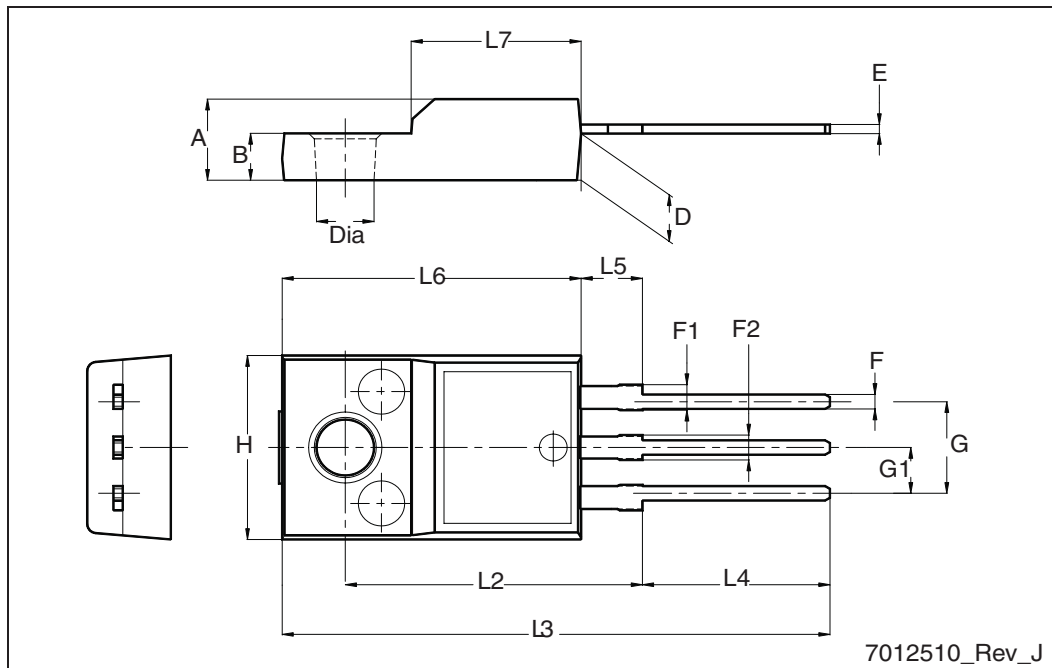

**TO-252 (DPAK) mechanical data**

DIM.	mm.		
	min.	typ	max.
A	2.20		2.40
A1	0.90		1.10
A2	0.03		0.23
b	0.64		0.90
b4	5.20		5.40
c	0.45		0.60
c2	0.48		0.60
D	6.00		6.20
D1		5.10	
E	6.40		6.60
E1		4.70	
e		2.28	
e1	4.40		4.60
H	9.35		10.10
L	1		
L1		2.80	
L2		0.80	
L4	0.60		1
R		0.20	
V2	0°		8°

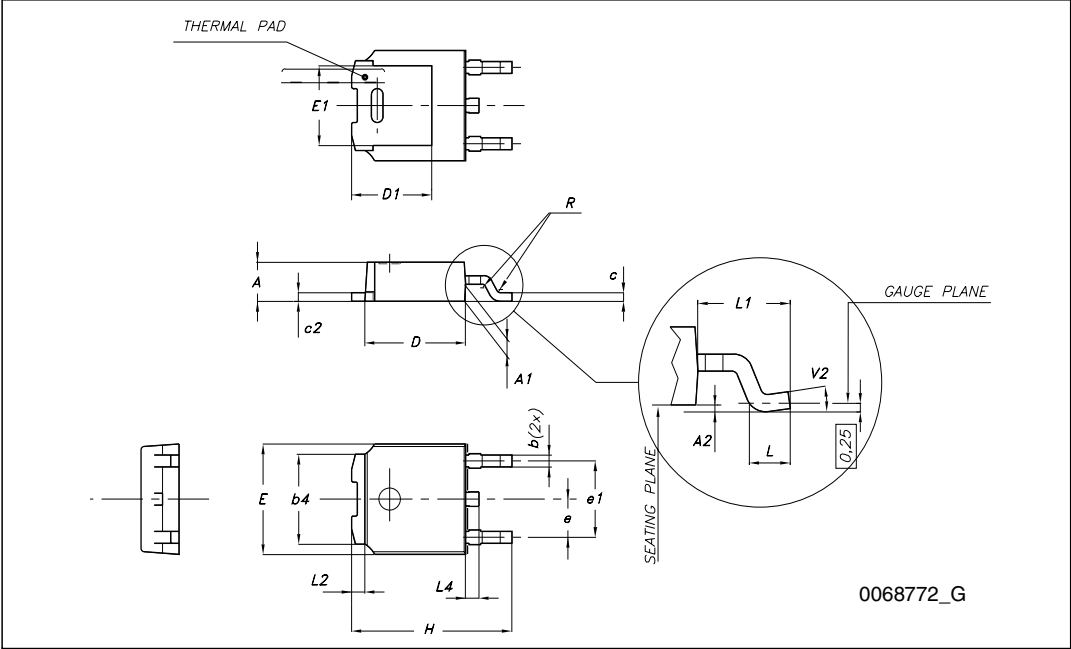

D<sup>2</sup>PAK (TO-263) mechanical data

Dim	mm			inch		
	Min	Typ	Max	Min	Typ	Max
A	4.40		4.60	0.173		0.181
A1	0.03		0.23	0.001		0.009
b	0.70		0.93	0.027		0.037
b2	1.14		1.70	0.045		0.067
c	0.45		0.60	0.017		0.024
c2	1.23		1.36	0.048		0.053
D	8.95		9.35	0.352		0.368
D1	7.50			0.295		
E	10		10.40	0.394		0.409
E1	8.50			0.334		
e		2.54			0.1	
e1	4.88		5.28	0.192		0.208
H	15		15.85	0.590		0.624
J1	2.49		2.69	0.099		0.106
L	2.29		2.79	0.090		0.110
L1	1.27		1.40	0.05		0.055
L2	1.30		1.75	0.051		0.069
R		0.4			0.016	
V2	0°		8°	0°		8°

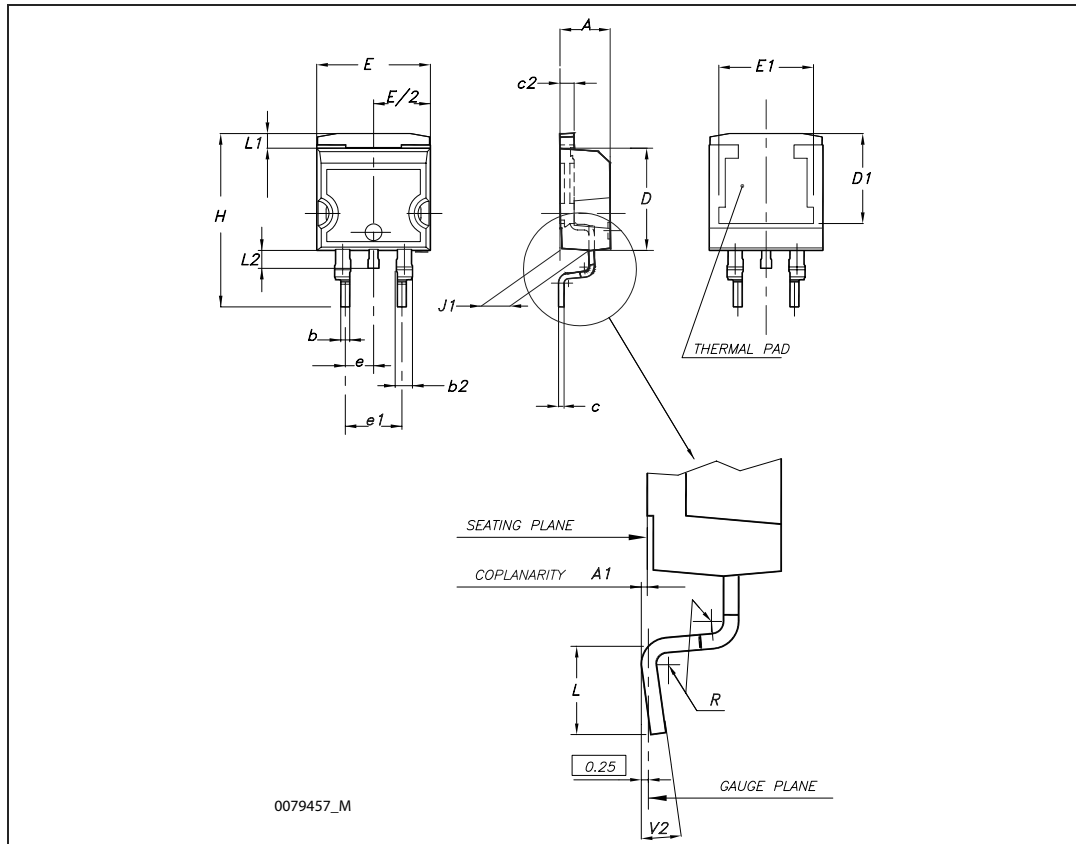

## 5 Packaging mechanical data

### DPAK FOOTPRINT

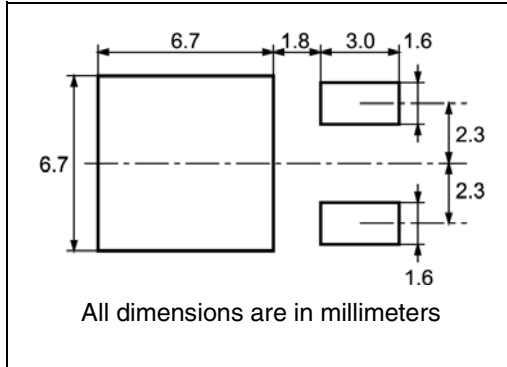

### TAPE AND REEL SHIPMENT

#### REEL MECHANICAL DATA

DIM.	mm		inch	
	MIN.	MAX.	MIN.	MAX.
A		330		12.992
B	1.5		0.059	
C	12.8	13.2	0.504	0.520
D	20.2		0.795	
G	16.4	18.4	0.645	0.724
N	50		1.968	
T		22.4		0.881

  

BASE QTY	BULK QTY
2500	2500

#### TAPE MECHANICAL DATA

DIM.	mm		inch	
	MIN.	MAX.	MIN.	MAX.
A0	6.8	7	0.267	0.275
B0	10.4	10.6	0.409	0.417
B1		12.1		0.476
D	1.5	1.6	0.059	0.063
D1	1.5		0.059	
E	1.65	1.85	0.065	0.073
F	7.4	7.6	0.291	0.299
K0	2.55	2.75	0.100	0.108
P0	3.9	4.1	0.153	0.161
P1	7.9	8.1	0.311	0.319
P2	1.9	2.1	0.075	0.082
R	40		1.574	
W	15.7	16.3	0.618	0.641

### D<sup>2</sup>PAK FOOTPRINT

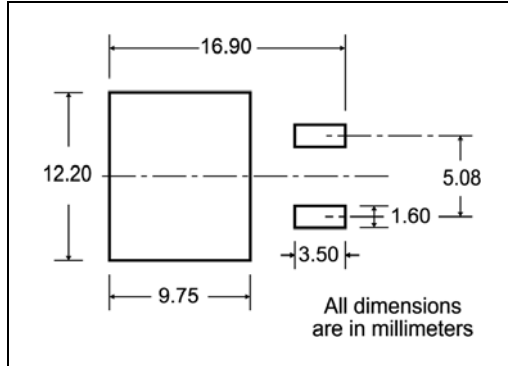

### TAPE AND REEL SHIPMENT

**TAPE MECHANICAL DATA**

DIM.	mm		inch	
	MIN.	MAX.	MIN.	MAX.
A0	10.5	10.7	0.413	0.421
B0	15.7	15.9	0.618	0.626
D	1.5	1.6	0.059	0.063
D1	1.59	1.61	0.062	0.063
E	1.65	1.85	0.065	0.073
F	11.4	11.6	0.449	0.456
K0	4.8	5.0	0.189	0.197
P0	3.9	4.1	0.153	0.161
P1	11.9	12.1	0.468	0.476
P2	1.9	2.1	0.075	0.082
R	50		1.574	
T	0.25	0.35	0.0098	0.0137
W	23.7	24.3	0.933	0.956

**REEL MECHANICAL DATA**

DIM.	mm		inch	
	MIN.	MAX.	MIN.	MAX.
A		330		12.992
B	1.5		0.059	
C	12.8	13.2	0.504	0.520
D	20.2		0.795	
G	24.4	26.4	0.960	1.039
N	100		3.937	
T		30.4		1.197

BASE QTY	BULK QTY
1000	1000

\* on sales type

## 6 Revision history

Table 9. Document revision history

Date	Revision	Changes
27-Mar-2009	1	First release
13-Aug-2009	2	Document status promoted from preliminary data to datasheet, inserted <a href="#">Section 2.1: Electrical characteristics (curves)</a> , updated TO-220 and TO-220FP package mechanical data

**Please Read Carefully:**

Information in this document is provided solely in connection with ST products. STMicroelectronics NV and its subsidiaries ("ST") reserve the right to make changes, corrections, modifications or improvements, to this document, and the products and services described herein at any time, without notice.

All ST products are sold pursuant to ST's terms and conditions of sale.

Purchasers are solely responsible for the choice, selection and use of the ST products and services described herein, and ST assumes no liability whatsoever relating to the choice, selection or use of the ST products and services described herein.

No license, express or implied, by estoppel or otherwise, to any intellectual property rights is granted under this document. If any part of this document refers to any third party products or services it shall not be deemed a license grant by ST for the use of such third party products or services, or any intellectual property contained therein or considered as a warranty covering the use in any manner whatsoever of such third party products or services or any intellectual property contained therein.

**UNLESS OTHERWISE SET FORTH IN ST'S TERMS AND CONDITIONS OF SALE ST DISCLAIMS ANY EXPRESS OR IMPLIED WARRANTY WITH RESPECT TO THE USE AND/OR SALE OF ST PRODUCTS INCLUDING WITHOUT LIMITATION IMPLIED WARRANTIES OF MERCHANTABILITY, FITNESS FOR A PARTICULAR PURPOSE (AND THEIR EQUIVALENTS UNDER THE LAWS OF ANY JURISDICTION), OR INFRINGEMENT OF ANY PATENT, COPYRIGHT OR OTHER INTELLECTUAL PROPERTY RIGHT.**

**UNLESS EXPRESSLY APPROVED IN WRITING BY AN AUTHORIZED ST REPRESENTATIVE, ST PRODUCTS ARE NOT RECOMMENDED, AUTHORIZED OR WARRANTED FOR USE IN MILITARY, AIR CRAFT, SPACE, LIFE SAVING, OR LIFE SUSTAINING APPLICATIONS, NOR IN PRODUCTS OR SYSTEMS WHERE FAILURE OR MALFUNCTION MAY RESULT IN PERSONAL INJURY, DEATH, OR SEVERE PROPERTY OR ENVIRONMENTAL DAMAGE. ST PRODUCTS WHICH ARE NOT SPECIFIED AS "AUTOMOTIVE GRADE" MAY ONLY BE USED IN AUTOMOTIVE APPLICATIONS AT USER'S OWN RISK.**

Resale of ST products with provisions different from the statements and/or technical features set forth in this document shall immediately void any warranty granted by ST for the ST product or service described herein and shall not create or extend in any manner whatsoever, any liability of ST.

ST and the ST logo are trademarks or registered trademarks of ST in various countries.

Information in this document supersedes and replaces all information previously supplied.

The ST logo is a registered trademark of STMicroelectronics. All other names are the property of their respective owners.

© 2009 STMicroelectronics - All rights reserved

STMicroelectronics group of companies

Australia - Belgium - Brazil - Canada - China - Czech Republic - Finland - France - Germany - Hong Kong - India - Israel - Italy - Japan - Malaysia - Malta - Morocco - Philippines - Singapore - Spain - Sweden - Switzerland - United Kingdom - United States of America

[www.st.com](http://www.st.com)

## Looking for pricing, stock, or lifecycle information?

Click below to explore more details on WIN SOURCE:

- ⊖ [View STGFL6NC60DI on WIN SOURCE](#)
- ⊖ [STMicroelectronics Information](#)

## Optimize Your Supply Chain with WIN SOURCE Solutions

- ✓ Global Sourcing Solution
- ✓ Obsolete Management
- ✓ Cost Control Management
- ✓ Shortage Management
- ✓ Alternative Solution
- ✓ Excess Inventory Management