



# THE DATASHEET OF CS20-14IO1



# Thyristor

$$V_{RRM} = 1400 \text{ V}$$

$$I_{TAV} = 20 \text{ A}$$

$$V_T = 1,23 \text{ V}$$

## Single Thyristor

### Part number

**CS20-14io1**

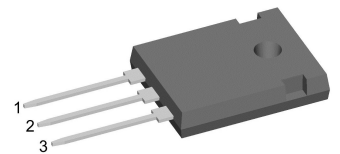

Backside: anode

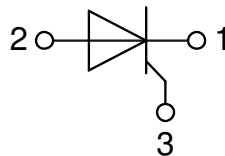

### Features / Advantages:

- Thyristor for line frequency
- Planar passivated chip
- Long-term stability

### Applications:

- Line rectifying 50/60 Hz
- Softstart AC motor control
- DC Motor control
- Power converter
- AC power control
- Lighting and temperature control

### Package: TO-247

- Industry standard outline
- RoHS compliant
- Epoxy meets UL 94V-0

### Terms Conditions of usage:

The data contained in this product data sheet is exclusively intended for technically trained staff. The user will have to evaluate the suitability of the product for the intended application and the completeness of the product data with respect to his application. The specifications of our components may not be considered as an assurance of component characteristics. The information in the valid application- and assembly notes must be considered. Should you require product information in excess of the data given in this product data sheet or which concerns the specific application of your product, please contact the sales office, which is responsible for you.

Due to technical requirements our product may contain dangerous substances. For information on the types in question please contact the sales office, which is responsible for you.

Should you intend to use the product in aviation, in health or live endangering or life support applications, please notify. For any such application we urgently recommend

- to perform joint risk and quality assessments;

- the conclusion of quality agreements;

- to establish joint measures of an ongoing product survey, and that we may make delivery dependent on the realization of any such measures.

Thyristor				Ratings			
Symbol	Definition	Conditions	min.	typ.	max.	Unit	
$V_{RSM/DSM}$	max. non-repetitive reverse/forward blocking voltage	$T_{VJ} = 25^{\circ}C$			1500	V	
$V_{RRM/DRM}$	max. repetitive reverse/forward blocking voltage	$T_{VJ} = 25^{\circ}C$			1400	V	
$I_{RD}$	reverse current, drain current	$V_{R/D} = 1400 V$	$T_{VJ} = 25^{\circ}C$		20	$\mu A$	
		$V_{R/D} = 1400 V$	$T_{VJ} = 125^{\circ}C$		2	mA	
$V_T$	forward voltage drop	$I_T = 20 A$	$T_{VJ} = 25^{\circ}C$		1,27	V	
		$I_T = 40 A$			1,53	V	
		$I_T = 20 A$	$T_{VJ} = 125^{\circ}C$		1,23	V	
		$I_T = 40 A$			1,57	V	
$I_{TAV}$	average forward current	$T_C = 130^{\circ}C$	$T_{VJ} = 150^{\circ}C$		20	A	
$I_{T(RMS)}$	RMS forward current	180° sine			31	A	
$V_{T0}$	threshold voltage	} for power loss calculation only	$T_{VJ} = 150^{\circ}C$		0,87	V	
$r_T$	slope resistance				17,3	m $\Omega$	
$R_{thJC}$	thermal resistance junction to case				0,6	K/W	
$R_{thCH}$	thermal resistance case to heatsink			0,25		K/W	
$P_{tot}$	total power dissipation		$T_C = 25^{\circ}C$		200	W	
$I_{TSM}$	max. forward surge current	$t = 10 ms$ ; (50 Hz), sine	$T_{VJ} = 45^{\circ}C$		260	A	
		$t = 8,3 ms$ ; (60 Hz), sine	$V_R = 0 V$		280	A	
		$t = 10 ms$ ; (50 Hz), sine	$T_{VJ} = 150^{\circ}C$		220	A	
		$t = 8,3 ms$ ; (60 Hz), sine	$V_R = 0 V$		240	A	
$I^2t$	value for fusing	$t = 10 ms$ ; (50 Hz), sine	$T_{VJ} = 45^{\circ}C$		340	A <sup>2</sup> s	
		$t = 8,3 ms$ ; (60 Hz), sine	$V_R = 0 V$		325	A <sup>2</sup> s	
		$t = 10 ms$ ; (50 Hz), sine	$T_{VJ} = 150^{\circ}C$		240	A <sup>2</sup> s	
		$t = 8,3 ms$ ; (60 Hz), sine	$V_R = 0 V$		240	A <sup>2</sup> s	
$C_J$	junction capacitance	$V_R = 400 V$ $f = 1 MHz$	$T_{VJ} = 25^{\circ}C$		16	pF	
$P_{GM}$	max. gate power dissipation	$t_p = 30 \mu s$	$T_C = 150^{\circ}C$		10	W	
		$t_p = 300 \mu s$			5	W	
$P_{GAV}$	average gate power dissipation				0,5	W	
$(di/dt)_{cr}$	critical rate of rise of current	$T_{VJ} = 125^{\circ}C$ ; $f = 50 Hz$ repetitive, $I_T = 60 A$			150	A/ $\mu s$	
		$t_p = 200 \mu s$ ; $di_G/dt = 0,3 A/\mu s$ ; $I_G = 0,3 A$ ; $V = \frac{2}{3} V_{DRM}$ non-repet., $I_T = 20 A$			500	A/ $\mu s$	
$(dv/dt)_{cr}$	critical rate of rise of voltage	$V = \frac{2}{3} V_{DRM}$ $R_{GK} = \infty$ ; method 1 (linear voltage rise)	$T_{VJ} = 125^{\circ}C$		1000	V/ $\mu s$	
$V_{GT}$	gate trigger voltage	$V_D = 6 V$	$T_{VJ} = 25^{\circ}C$		1,3	V	
			$T_{VJ} = -40^{\circ}C$		1,6	V	
$I_{GT}$	gate trigger current	$V_D = 6 V$	$T_{VJ} = 25^{\circ}C$		50	mA	
			$T_{VJ} = -40^{\circ}C$		80	mA	
$V_{GD}$	gate non-trigger voltage	$V_D = \frac{2}{3} V_{DRM}$	$T_{VJ} = 125^{\circ}C$		0,2	V	
$I_{GD}$	gate non-trigger current				5	mA	
$I_L$	latching current	$t_p = 10 \mu s$	$T_{VJ} = 25^{\circ}C$		150	mA	
		$I_G = 0,3 A$ ; $di_G/dt = 0,3 A/\mu s$					
$I_H$	holding current	$V_D = 6 V$ $R_{GK} = \infty$	$T_{VJ} = 25^{\circ}C$		100	mA	
$t_{gd}$	gate controlled delay time	$V_D = \frac{1}{2} V_{DRM}$	$T_{VJ} = 25^{\circ}C$		2	$\mu s$	
		$I_G = 0,3 A$ ; $di_G/dt = 0,3 A/\mu s$					
$t_q$	turn-off time	$V_R = 100 V$ ; $I_T = 20 A$ ; $V = \frac{2}{3} V_{DRM}$ $di/dt = 15 A/\mu s$ $dv/dt = 20 V/\mu s$ $t_p = 200 \mu s$	$T_{VJ} = 125^{\circ}C$		150	$\mu s$	

Package TO-247			Ratings			
Symbol	Definition	Conditions	min.	typ.	max.	Unit
$I_{RMS}$	RMS current	per terminal			70	A
$T_{VJ}$	virtual junction temperature		-40		150	°C
$T_{op}$	operation temperature		-40		125	°C
$T_{stg}$	storage temperature		-40		150	°C
<b>Weight</b>				6		g
$M_D$	mounting torque		0,8		1,2	Nm
$F_C$	mounting force with clip		20		120	N

### Product Marking

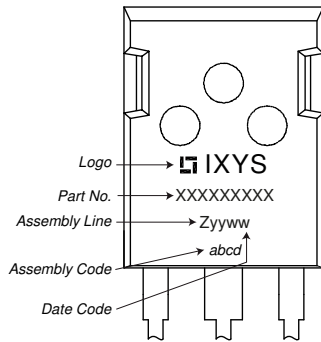

Ordering	Ordering Number	Marking on Product	Delivery Mode	Quantity	Code No.
Standard	CS20-14io1	CS20-14io1	Tube	30	466522

Similar Part	Package	Voltage class
CS20-12io1	TO-247AD (3)	1200
CS20-16io1	TO-247AD (3)	1600

### Equivalent Circuits for Simulation

\* on die level

$T_{VJ} = 150\text{ °C}$

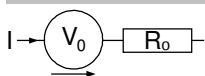

Thyristor

$V_{0\ max}$	threshold voltage	0,87	V
$R_{0\ max}$	slope resistance *	14,8	mΩ

## Outlines TO-247

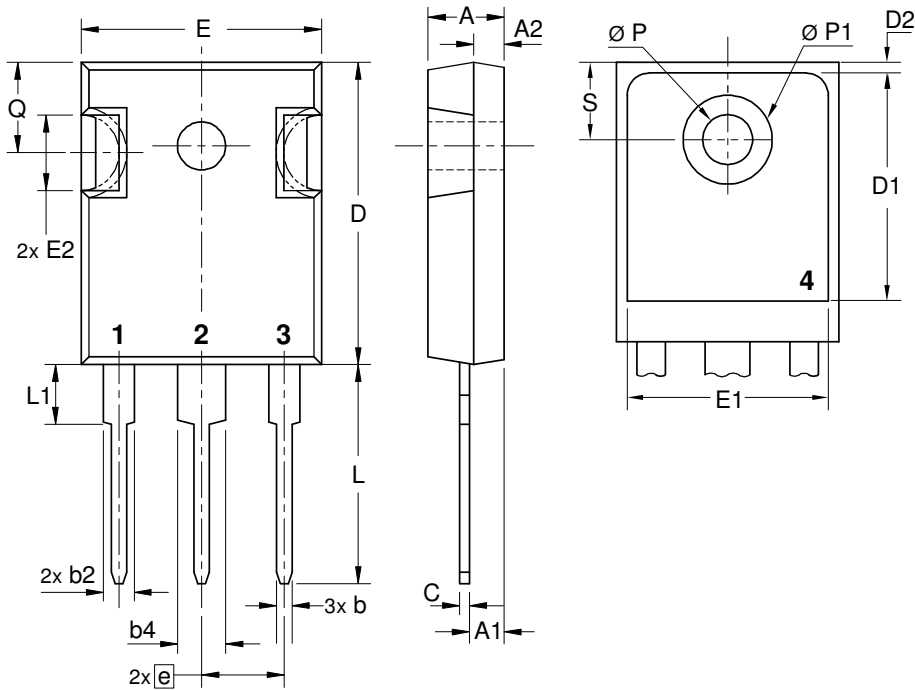

Sym.	Inches		Millimeter	
	min.	max.	min.	max.
A	0.185	0.209	4.70	5.30
A1	0.087	0.102	2.21	2.59
A2	0.059	0.098	1.50	2.49
D	0.819	0.845	20.79	21.45
E	0.610	0.640	15.48	16.24
E2	0.170	0.216	4.31	5.48
e	0.215	BSC	5.46	BSC
L	0.780	0.800	19.80	20.30
L1	-	0.177	-	4.49
Ø P	0.140	0.144	3.55	3.65
Q	0.212	0.244	5.38	6.19
S	-	0.242 BSC	-	6.14 BSC
b	0.039	0.055	0.99	1.40
b2	0.065	0.094	1.65	2.39
b4	0.102	0.135	2.59	3.43
c	0.015	0.035	0.38	0.89
D1	0.515	-	13.07	-
D2	0.020	0.053	0.51	1.35
E1	0.530	-	13.45	-
Ø P1	-	0.29	-	7.39

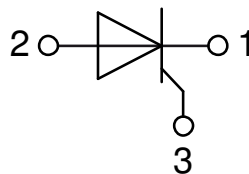

**Thyristor**

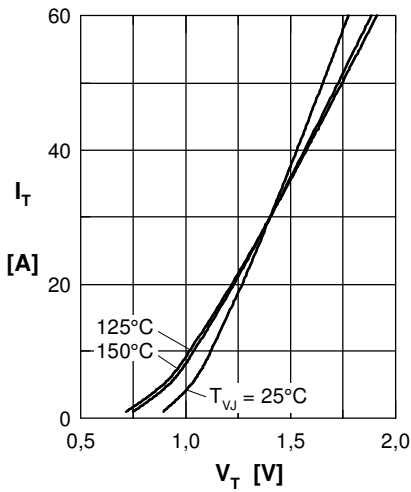

Fig. 1 Forward characteristics

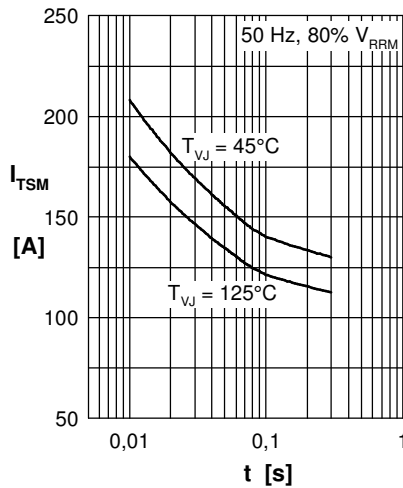

Fig. 2 Surge overload current

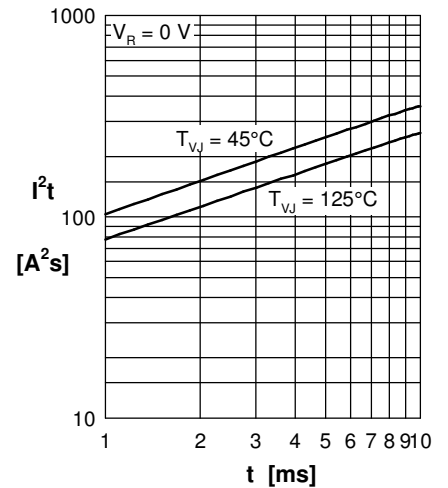

Fig. 3  $I^2t$  versus time (1-10 ms)

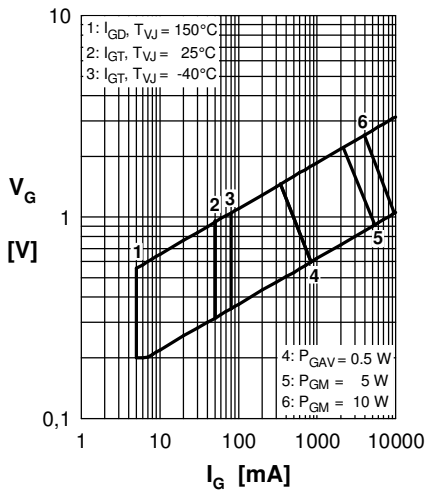

Fig. 4 Gate trigger characteristics

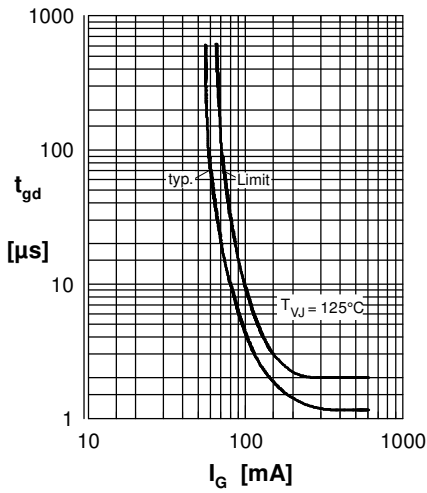

Fig. 5 Gate controlled delay time

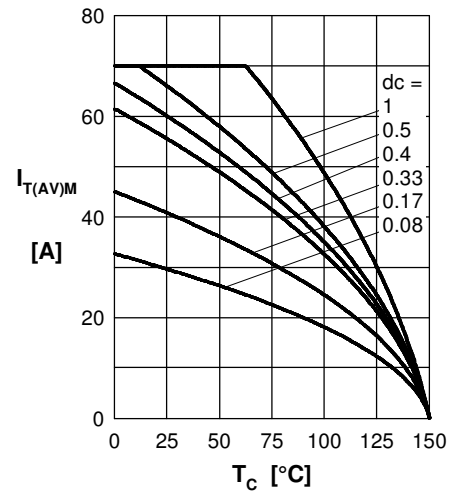

Fig. 6 Max. forward current at case temperature

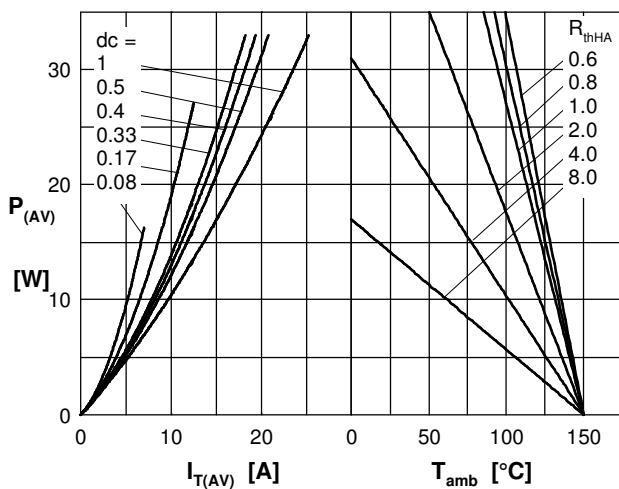

Fig. 7a Power dissipation versus direct output current  
Fig. 7b and ambient temperature

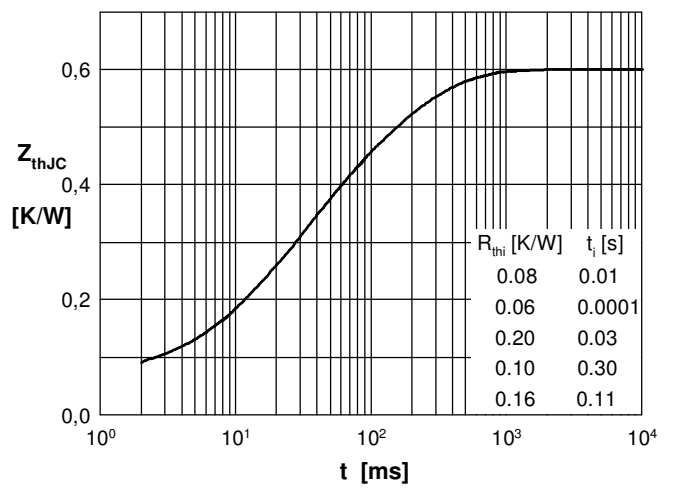

Fig. 8 Transient thermal impedance junction to case

## Looking for pricing, stock, or lifecycle information?

Click below to explore more details on WIN SOURCE:

- ⊖ [View CS20-14IO1 on WIN SOURCE](#)
- ⊖ [IXYS Information](#)

## Optimize Your Supply Chain with WIN SOURCE Solutions

- ✓ Global Sourcing Solution
- ✓ Obsolete Management
- ✓ Cost Control Management
- ✓ Shortage Management
- ✓ Alternative Solution
- ✓ Excess Inventory Management