

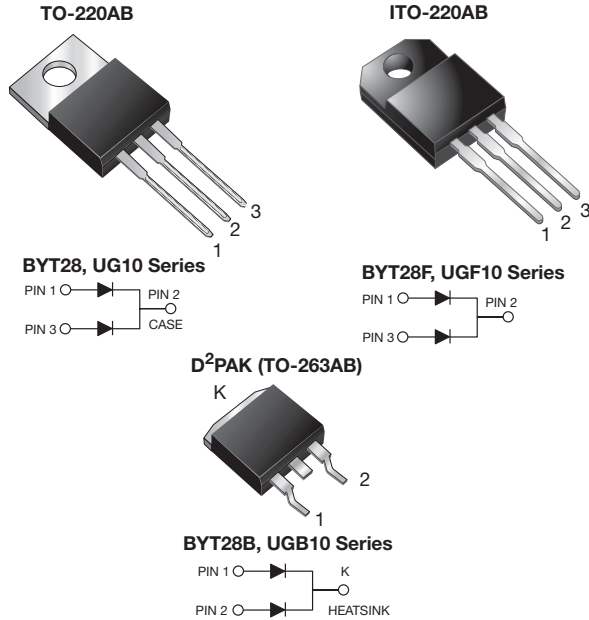

**THE DATASHEET OF
BYT28F-400-E3/45**



Dual Common Cathode Ultrafast Soft Recovery Rectifier



FEATURES

- Power pack
- Glass passivated pellet chip junction
- Ultrafast recovery time
- Low switching losses, high efficiency
- Low forward voltage drop
- High forward surge capability
- Meets MSL level 1, per J-STD-020, LF maximum peak of 245 °C (for TO-263AB package)
- Solder dip 275 °C max. 10 s, per JESD 22-B106 (for TO-220AB and ITO-220AB package)
- AEC-Q101 qualified available
 - Automotive ordering code: base P/NHE3 (for ITO-220AB and D²PAK (TO-263AB package))
- Material categorization: for definitions of compliance please see www.vishay.com/doc?99912

RoHS
COMPLIANT

TYPICAL APPLICATIONS

For use in high frequency rectifier of switching mode power supplies, inverters, freewheeling diodes, DC/DC converters, and other power switching application.

DESIGN SUPPORT TOOLS AVAILABLE



PRIMARY CHARACTERISTICS

$I_{F(AV)}$	2 x 5.0 A
V_{RRM}	300 V to 400 V
I_{FSM}	60 A
t_{rr}	35 ns
V_F	1.05 V
T_J max.	150 °C
Package	TO-220AB, ITO-220AB, D ² PAK (TO-263AB)
Circuit configurations	Common cathode

MECHANICAL DATA

Case: TO-220AB, ITO-220AB, D²PAK (TO-263AB)

Molding compound meets UL 94 V-0 flammability rating
Base P/N-E3 - RoHS-compliant, commercial grade
Base P/NHE3_X - RoHS-compliant and AEC-Q101 qualified ("X" denotes revision code e.g. A, B,...)

Terminals: matte tin plated leads, solderable per J-STD-002 and JESD 22-B102

E3 suffix meets JESD 201 class 1A whisker test, HE3 suffix meets JESD 201 class 2 whisker test

Polarity: as marked

Mounting Torque: 10 in-lbs maximum

MAXIMUM RATINGS ($T_C = 25$ °C unless otherwise noted)

PARAMETER	SYMBOL	BYT28-300 UG10FCT	BYT28-400 UG10GCT	UNIT
Maximum repetitive peak reverse voltage	V_{RRM}	300	400	V
Maximum working reverse voltage	V_{RWM}	300	400	V
Maximum RMS voltage	V_{RMS}	210	280	V
Maximum DC blocking voltage	V_{DC}	300	400	V
Maximum average forward rectified current at $T_C = 100$ °C	$I_{F(AV)}$	total device		A
		per diode		
Peak forward surge current 8.3 ms single half sine-wave superimposed on rated load per diode	I_{FSM}	60		A
Operating junction and storage temperature range	T_J, T_{STG}	-40 to +150		°C
Isolation voltage (ITO-220AB only) from terminal to heatsink $t = 1$ min	V_{AC}	1500		V



ELECTRICAL CHARACTERISTICS ($T_C = 25\text{ }^\circ\text{C}$ unless otherwise noted)					
PARAMETER	TEST CONDITIONS		SYMBOL	VALUE	UNIT
Maximum instantaneous forward voltage per diode	$I_F = 5\text{ A}$	$T_J = 25\text{ }^\circ\text{C}$	$V_F^{(1)}$	1.30	V
	$I_F = 10\text{ A}$			1.40	
	$I_F = 5\text{ A}$	$T_J = 150\text{ }^\circ\text{C}$		1.05	
Maximum reverse current per diode at V_{RRM}			I_R	10	μA
				$T_J = 100\text{ }^\circ\text{C}$	
Maximum reverse recovery time per diode	$I_F = 0.5\text{ A}, I_R = 1.0\text{ A}, I_{rr} = 0.25\text{ A}$		t_{rr}	35	ns
	$I_F = 1.0\text{ A}, di/dt = 100\text{ A}/\mu\text{s}, V_R = 30\text{ V}, I_{rr} = 0.1 I_{RM}$			50	
Maximum reverse recovery current per diode	$I_F = 5\text{ A}, di/dt = 50\text{ A}/\mu\text{s}, V_R = 30\text{ V}, T_C = 100\text{ }^\circ\text{C}$		I_{RM}	3.0	A
Maximum stored charge per diode	$I_F = 2\text{ A}, di/dt = 20\text{ A}/\mu\text{s}, V_R = 30\text{ V}, I_{rr} = 0.1 I_{RM}$		Q_{rr}	50	nC

Note

(1) Pulse test: 300 μs pulse width, 1 % duty cycle

THERMAL CHARACTERISTICS ($T_C = 25\text{ }^\circ\text{C}$ unless otherwise noted)					
PARAMETER	SYMBOL	BYT28 UG10	BYT28F UGF10	BYT28B UGB10	UNIT
Typical thermal resistance junction to case per diode	$R_{\theta JC}$	4.5	6.7	4.5	$^\circ\text{C}/\text{W}$

ORDERING INFORMATION (Example)					
PACKAGE	PREFERRED P/N	UNIT WEIGHT (g)	PACKAGE CODE	BASE QUANTITY	DELIVERY MODE
TO-220AB	BYT28-400-E3/45	1.80	45	50/tube	Tube
ITO-220AB	BYT28F-400-E3/45	1.95	45	50/tube	Tube
TO-263AB	BYT28B-400-E3/45	1.77	45	50/tube	Tube
TO-263AB	BYT28B-400-E3/81	1.77	81	800/reel	Tape and reel
ITO-220AB	BYT28F-400HE3_A/P (1)	1.95	P	50/tube	Tube
TO-263AB	BYT28B-400HE3_A/P (1)	1.77	P	50/tube	Tube
TO-263AB	BYT28B-400HE3_A/I (1)	1.77	I	800/reel	Tape and reel

Note

(1) AEC-Q101 qualified, available in ITO-220AB and TO-263AB package



RATINGS AND CHARACTERISTICS CURVES (T_A = 25 °C unless otherwise noted)

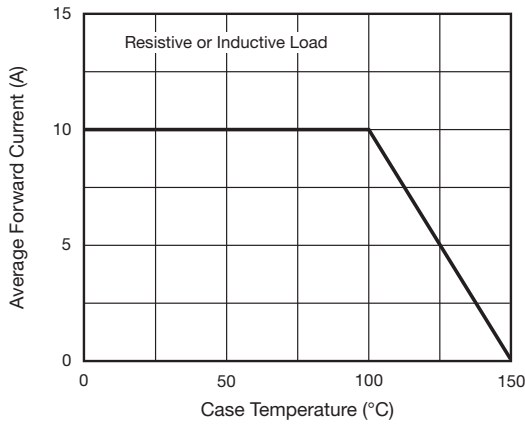

Fig. 1 - Forward Current Derating Curve

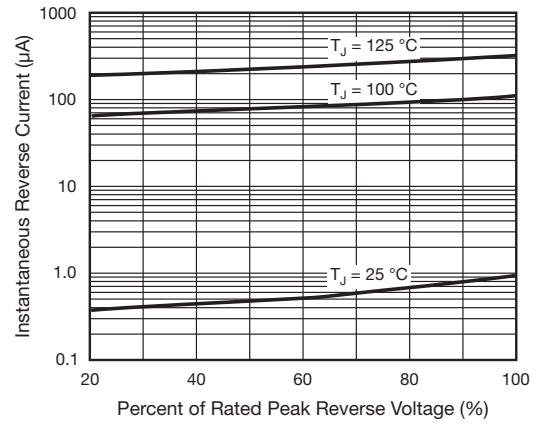

Fig. 4 - Typical Reverse Characteristics Per Diode

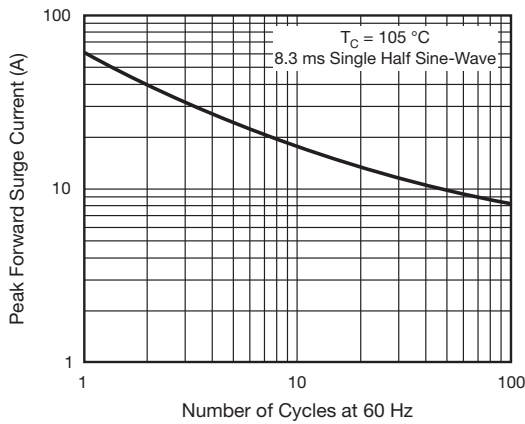

Fig. 2 - Maximum Non-Repetitive Peak Forward Surge Current Per Diode

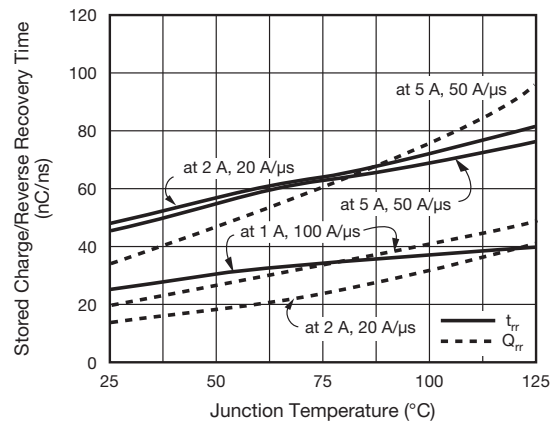

Fig. 5 - Reverse Switching Characteristics Per Diode

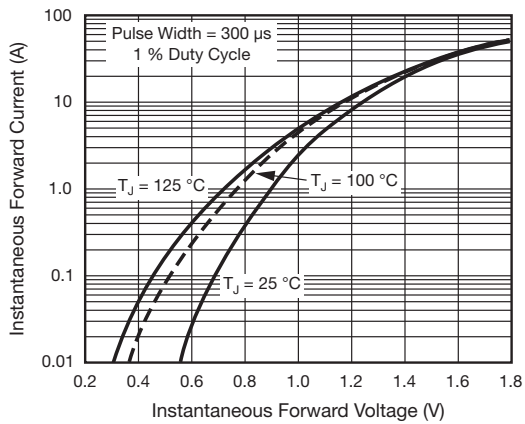

Fig. 3 - Typical Instantaneous Forward Characteristics Per Diode

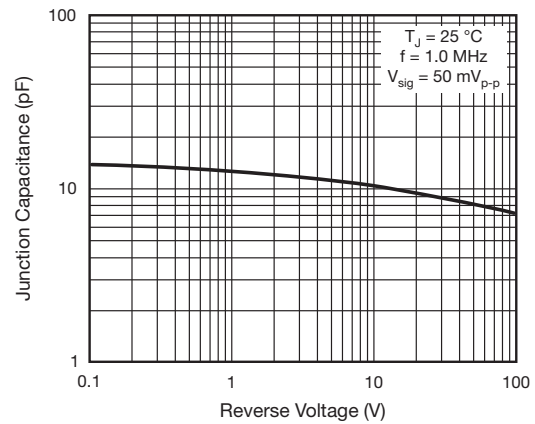
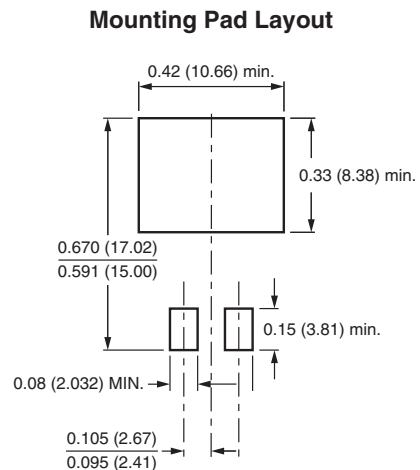
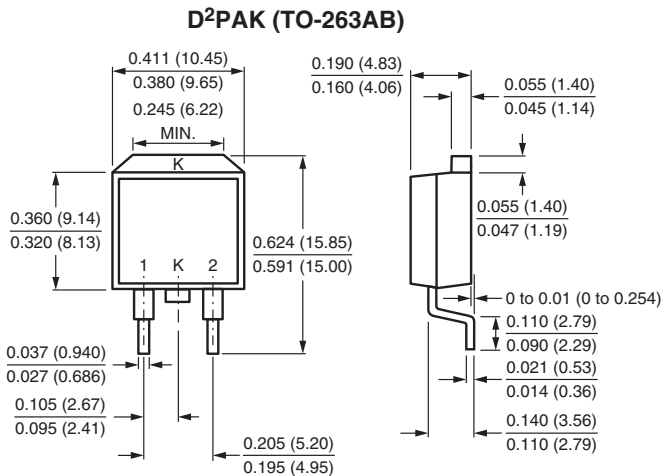
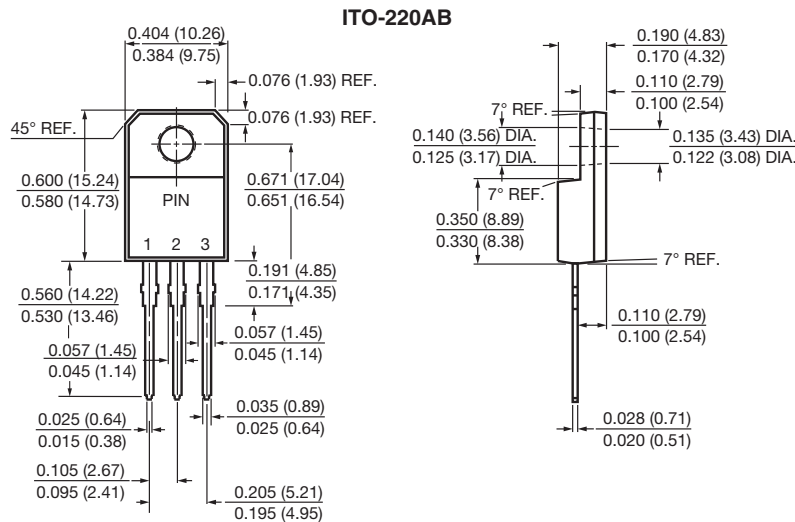
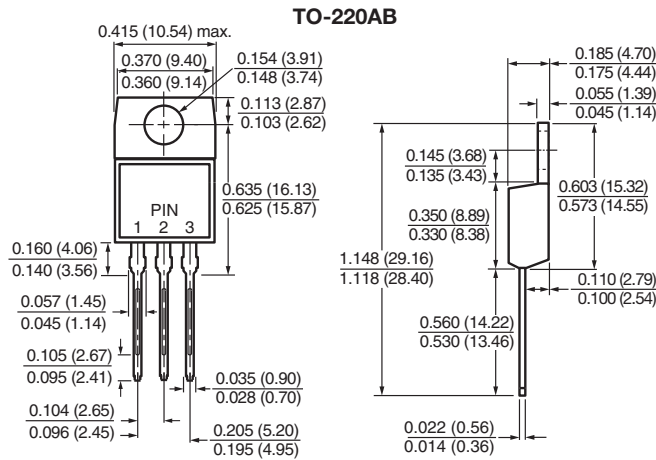

Fig. 6 - Typical Junction Capacitance Per Diode



PACKAGE OUTLINE DIMENSIONS in inches (millimeters)





Disclaimer

ALL PRODUCT, PRODUCT SPECIFICATIONS AND DATA ARE SUBJECT TO CHANGE WITHOUT NOTICE TO IMPROVE RELIABILITY, FUNCTION OR DESIGN OR OTHERWISE.

Vishay Intertechnology, Inc., its affiliates, agents, and employees, and all persons acting on its or their behalf (collectively, "Vishay"), disclaim any and all liability for any errors, inaccuracies or incompleteness contained in any datasheet or in any other disclosure relating to any product.

Vishay makes no warranty, representation or guarantee regarding the suitability of the products for any particular purpose or the continuing production of any product. To the maximum extent permitted by applicable law, Vishay disclaims (i) any and all liability arising out of the application or use of any product, (ii) any and all liability, including without limitation special, consequential or incidental damages, and (iii) any and all implied warranties, including warranties of fitness for particular purpose, non-infringement and merchantability.

Statements regarding the suitability of products for certain types of applications are based on Vishay's knowledge of typical requirements that are often placed on Vishay products in generic applications. Such statements are not binding statements about the suitability of products for a particular application. It is the customer's responsibility to validate that a particular product with the properties described in the product specification is suitable for use in a particular application. Parameters provided in datasheets and / or specifications may vary in different applications and performance may vary over time. All operating parameters, including typical parameters, must be validated for each customer application by the customer's technical experts. Product specifications do not expand or otherwise modify Vishay's terms and conditions of purchase, including but not limited to the warranty expressed therein.

Except as expressly indicated in writing, Vishay products are not designed for use in medical, life-saving, or life-sustaining applications or for any other application in which the failure of the Vishay product could result in personal injury or death. Customers using or selling Vishay products not expressly indicated for use in such applications do so at their own risk. Please contact authorized Vishay personnel to obtain written terms and conditions regarding products designed for such applications.

No license, express or implied, by estoppel or otherwise, to any intellectual property rights is granted by this document or by any conduct of Vishay. Product names and markings noted herein may be trademarks of their respective owners.

Looking for pricing, stock, or lifecycle information?

Click below to explore more details on WIN SOURCE:

 [View BYT28F-400-E3/45 on WIN SOURCE](#)

 [Vishay Information](#)

Optimize Your Supply Chain with WIN SOURCE Solutions

-  Global Sourcing Solution
-  Obsolete Management
-  Cost Control Management
-  Shortage Management
-  Alternative Solution
-  Excess Inventory Management