



**THE DATASHEET OF  
AD1854JRSZRL**



### FEATURES

- 5 V Stereo Audio DAC System**
- Accepts 16-/18-/20-/24-Bit Data**
- Supports 24 Bits and 96 kHz Sample Rate**
- Multibit Sigma-Delta Modulator with "Perfect Differential Linearity Restoration" for Reduced Idle Tones and Noise Floor**
- Data Directed Scrambling DAC—Least Sensitive to Jitter**
- Differential Output for Optimum Performance**
- 113 dB Dynamic Range at 48 kHz Sample Rate (AD1854KRS)**
- 112 dB Signal-to-Noise at 48 kHz Sample Rate (AD1854KRS)**
- 101 THD+N (AD1854KRS)**
- On-Chip Volume Control with 1024 Steps**
- Hardware and Software Controllable Clickless Mute**
- Zero Input Flag Outputs for Left and Right Channels**
- Digital De-Emphasis Processing**
- Supports  $256 \times F_S$  or  $384 \times F_S$  Master Mode Clock**
- Switchable Clock Doubler**
- Power-Down Mode Plus Soft Power-Down Mode**
- Flexible Serial Data Port with Right-Justified, Left-Justified, and I<sup>2</sup>S-Compatible**
- 28-Lead SSOP Plastic Package**

### APPLICATIONS

DVD, CD, Set-Top Boxes, Home Theater Systems, Automotive Audio Systems, Sampling Musical Keyboards, Digital Mixing Consoles, Digital Audio Effects Processors

### PRODUCT OVERVIEW

The AD1854 is a high performance, single-chip stereo, audio DAC delivering 113 dB Dynamic Range and 112 dB SNR (A-weighted—not muted) at 48 kHz sample rate. It is comprised of a multibit sigma-delta modulator with dither, continuous time analog filters and analog output drive circuitry. Other features include an on-chip stereo attenuator and mute, programmed through an SPI-compatible serial control port. The AD1854 is fully compatible with current DVD formats, including 96 kHz sample frequency and 24 bits. It is also backwards compatible by supporting 50  $\mu$ s/15  $\mu$ s digital de-emphasis intended for "redbook" 44.1 kHz sample frequency playback from compact discs.

The AD1854 has a very simple but very flexible serial data input port that allows for glueless interconnection to a variety of ADCs, DSP chips, AES/EBU receivers and sample rate converters. The AD1854 can be configured in left-justified, I<sup>2</sup>S, and right-justified. The AD1854 accepts serial audio data in MSB first, two's-complement format. A power-down mode is offered to minimize power consumption when the device is inactive. The AD1854 operates from a single 5 V power supply. It is fabricated on a single monolithic integrated circuit and housed in a 28-lead SSOP package for operation over the temperature range 0°C to 70°C.

### FUNCTIONAL BLOCK DIAGRAM

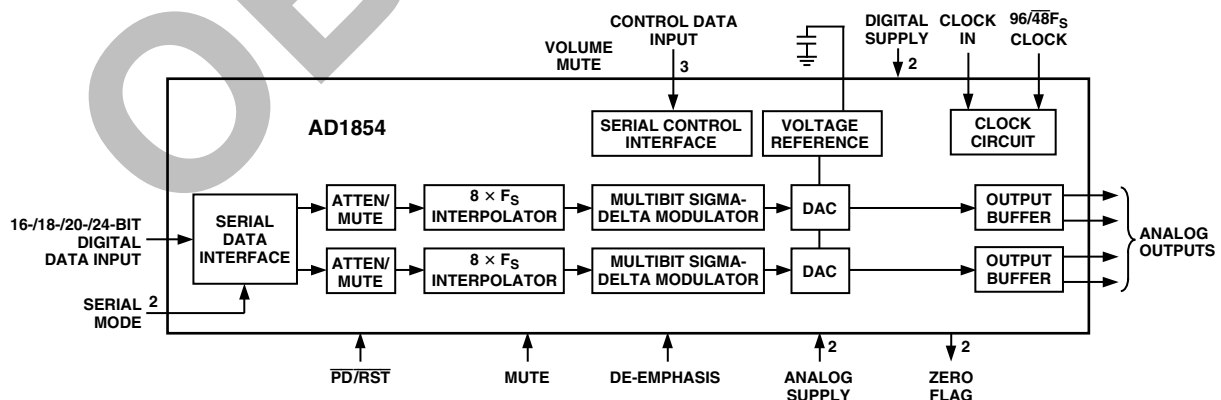

REV. A

Information furnished by Analog Devices is believed to be accurate and reliable. However, no responsibility is assumed by Analog Devices for its use, nor for any infringements of patents or other rights of third parties which may result from its use. No license is granted by implication or otherwise under any patent or patent rights of Analog Devices.

# AD1854—SPECIFICATIONS

## TEST CONDITIONS UNLESS OTHERWISE NOTED

Supply Voltages ( $V_{DD}$ , $DV_{DD}$ )	5.0 V
Ambient Temperature	25°C
Input Clock	12.288 MHz ( $256 \times F_S$ Mode)
Input Signal	1.0013 kHz
	-0.5 dB Full Scale
Input Sample Rate	48 kHz
Measurement Bandwidth	20 Hz to 20 kHz
Word Width	20 Bits
Load Capacitance	100 pF
Load Impedance	47 k $\Omega$
Input Voltage HI	2.4 V
Input Voltage LO	0.8 V

Performance of right and left channels are identical (exclusive of the Interchannel Gain Mismatch and Interchannel Phase Deviation specifications).

## ANALOG PERFORMANCE

	Min	Typ	Max	Unit
Resolution		20		Bits
Signal-to-Noise Ratio (20 Hz to 20 kHz)				
No Filter (AD1854JRS)		105		dB
No Filter (AD1854KRS)		110		dB
With A-Weighted Filter (AD1854JRS)		108		dB
With A-Weighted Filter (AD1854KRS)		112		dB
Dynamic Range (20 Hz to 20 kHz, -60 dB Input)				
No Filter (AD1854JRS)		105		dB
No Filter (AD1854KRS)	106	110		dB
With A-Weighted Filter (AD1854JRS)		108		dB
With A-Weighted Filter (AD1854KRS)	108	113		dB
Total Harmonic Distortion + Noise (AD1854JRS) $V_O = 0$ dB	-88	-97		dB
Total Harmonic Distortion + Noise (AD1854KRS) $V_O = 0$ dB	-94	-101		dB
Total Harmonic Distortion + Noise (AD1854JRS and AD1854KRS) $V_O = -20$ dB		-89		dB
Total Harmonic Distortion + Noise (AD1854JRS and AD1854KRS) $V_O = -60$ dB		-49		dB
Analog Outputs				
Differential Output Range ( $\pm$ Full Scale)		5.6		V p-p
Output Impedance at Each Output Pin		<200		$\Omega$
Output Capacitance at Each Output Pin			20	pF
Out-of-Band Energy ( $0.5 \times F_S$ to 100 kHz)			-72.5	dB
CMOUT		2.25		V
DC Accuracy				
Gain Error	-11.0	$\pm 3.0$	+11.0	%
Interchannel Gain Mismatch	-0.15		+0.15	dB
Gain Drift		200	300	ppm/ $^{\circ}$ C
Interchannel Crosstalk (EIAJ Method)		-120		dB
Interchannel Phase Deviation		$\pm 0.1$		Degrees
Mute Attenuation		-100		dB
De-Emphasis Gain Error			$\pm 0.1$	dB

## DIGITAL I/O (0°C to 70°C)

	Min	Typ	Max	Unit
Input Voltage HI ( $V_{IH}$ )	2.2			V
Input Voltage LO ( $V_{IL}$ )			0.8	V
High Level Output Voltage ( $V_{OH}$ ) $I_{OH} = 1$ mA	2.0			V
Low Level Output Voltage ( $V_{OL}$ ) $I_{OL} = 1$ mA			0.4	V
Input Leakage ( $I_{IH}$ @ $V_{IH} = 2.4$ V)			10	$\mu$ A
Input Leakage ( $I_{IL}$ @ $V_{IL} = 0.8$ V)			10	$\mu$ A
Input Capacitance			20	pF

**POWER**

	Min	Typ	Max	Unit
Supplies				
Voltage, Analog and Digital	4.5	5	5.5	V
Analog Current	26	30	35	mA
Analog Current—Power-Down	26	29	33.5	mA
Digital Current	14	17	20	mA
Digital Current—Power-Down	1.5	2.5	5.5	mA
Dissipation				
Operation—Both Supplies		250		mW
Operation—Analog Supply		150		mW
Operation—Digital Supply		100		mW
Power-Down—Both Supplies			190	mW
Power Supply Rejection Ratio				
1 kHz 300 mV p-p Signal at Analog Supply Pins		-60		dB
20 kHz 300 mV p-p Signal at Analog Supply Pins		-50		dB

**TEMPERATURE RANGE**

	Min	Typ	Max	Unit
Specifications Guaranteed		25		°C
Functionality Guaranteed	0		70	°C
Storage	-55		+125	°C

**DIGITAL TIMING (Guaranteed over 0°C to 70°C,  $AV_{DD} = DV_{DD} = 5.0 V \pm 10\%$ )**

	Min	Max	Unit
$t_{DMP}$ MCLK Period (512 $F_S$ Mode)	35		ns
$t_{DMP}$ MCLK Period (384 $F_S$ Mode)	48		ns
$t_{DMP}$ MCLK Period (256 $F_S$ Mode)	70		ns
$t_{DML}$ MCLK LO Pulsewidth (All Mode)	$0.4 \times t_{DMP}$		ns
$t_{DMH}$ MCLK HI Pulsewidth (All Mode)	$0.4 \times t_{DMP}$		ns
$t_{DBH}$ BCLK HI Pulsewidth	20		ns
$t_{DBL}$ BCLK LO Pulsewidth	20		ns
$t_{DBP}$ BCLK Period	140		ns
$t_{DLS}$ $L/\overline{R}$ CLK Setup	20		ns
$t_{DLH}$ $L/\overline{R}$ CLK Hold (DSP Serial Port Mode Only)	5		ns
$t_{DDS}$ SDATA Setup	5		ns
$t_{DDH}$ SDATA Hold	10		ns
$t_{PDRP}$ $\overline{PD}/\overline{RST}$ LO Pulsewidth	4 MCLK Periods		ns

**DIGITAL FILTER CHARACTERISTICS**

	Min	Typ	Max	Unit
Passband Ripple		$\pm 0.04$		dB
Stopband Attenuation		47		dB
Passband		0.448		$F_S$
Stopband		0.552		$F_S$
Group Delay		$106/F_S$		sec
Group Delay Variation		0		$\mu s$

Specifications subject to change without notice.

# AD1854

## ABSOLUTE MAXIMUM RATINGS\*

	Min	Max	Unit
DV <sub>DD</sub> to DGND	-0.3	+6	V
AV <sub>DD</sub> to AGND	-0.3	+6	V
Digital Inputs	DGND - 0.3	DV <sub>DD</sub> + 0.3	V
Analog Outputs	AGND - 0.3	AV <sub>DD</sub> + 0.3	V
AGND to DGND	-0.3	+0.3	V
Reference Voltage		(AV <sub>DD</sub> + 0.3)/2	°C
Soldering		300	sec
		10	

\*Stresses greater than those listed under Absolute Maximum Ratings may cause permanent damage to the device. This is a stress rating only; functional operation of the device at these or any other conditions above those indicated in the operational section of this specification is not implied. Exposure to absolute maximum rating conditions for extended periods may affect device reliability.

## PACKAGE CHARACTERISTICS

	Min	Typ	Max	Unit
$\theta_{JA}$ (Thermal Resistance [Junction-to-Ambient])		109		°C/W
$\theta_{JC}$ (Thermal Resistance [Junction-to-Case])		39		°C/W

## PIN CONFIGURATION

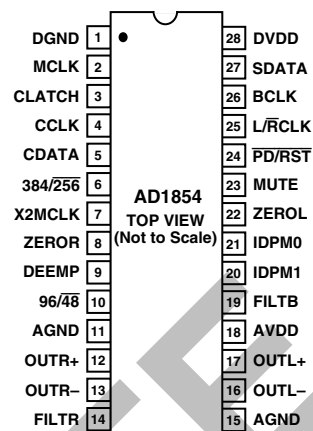

## ORDERING GUIDE

Model	Temperature	Package Description	Package Option
AD1854JRS	0°C to 70°C	28-Lead Shrink Small Outline	RS-28
AD1854JRSRL	0°C to 70°C	28-Lead Shrink Small Outline	RS-28 on 13" Reels
AD1854KRS	0°C to 70°C	28-Lead Shrink Small Outline	RS-28
AD1854KRSRL	0°C to 70°C	28-Lead Shrink Small Outline	RS-28 on 13" Reels

## CAUTION

ESD (electrostatic discharge) sensitive device. Electrostatic charges as high as 4000 V readily accumulate on the human body and test equipment and can discharge without detection. Although the AD1854 features proprietary ESD protection circuitry, permanent damage may occur on devices subjected to high-energy electrostatic discharges. Therefore, proper ESD precautions are recommended to avoid performance degradation or loss of functionality.



## PIN FUNCTION DESCRIPTIONS

Pin	Input/Output	Pin Name	Description
1	I	DGND	Digital Ground.
2	I	MCLK	Master Clock Input. Connect to an external clock source at either 256, 384 or 512 F <sub>s</sub> .
3	I	CLATCH	Latch input for control data. This input is rising-edge sensitive.
4	I	CCLK	Control clock input for control data. Control input data must be valid on the rising edge of CCLK. CCLK may be continuous or gated.
5	I	CDATA	Serial control input, MSB first, containing 16 bits of unsigned data per channel. Used for specifying channel-specific attenuation and mute.
6	I	$\overline{384/256}$	Selects the master clock mode as either 384 times the intended sample frequency (HI) or 256 times the intended sample frequency (LO). The state of this input should be hardwired to logic HI or logic LO, or may be changed while the AD1854 is in power-down/reset. It must not be changed while the AD1854 is operational.
7	I	X2MCLK	Selects internal clock doubler (LO) or internal clock = MCLK (HI).
8	O	ZEROR	Right Channel Zero Flag Output. This pin goes HI when Right Channel has no signal input for more than 1024 LR Clock Cycles.
9	I	DEEMP	De-Emphasis. Digital de-emphasis is enabled when this input signal is HI. This is used to impose a 50 $\mu$ s/15 $\mu$ s response characteristic on the output audio spectrum at an assumed 44.1 kHz sample rate.
10	I	$\overline{96/48}$	Selects 48 kHz (LO) or 96 kHz Sample Frequency Control.
11, 15	I	AGND	Analog Ground.
12	O	OUTR+	Right Channel Positive line level analog output.
13	O	OUTR-	Right Channel Negative line level analog output.
14	O	FILTR	Voltage Reference Filter Capacitor Connection. Bypass and decouple the voltage reference with parallel 10 $\mu$ F and 0.1 $\mu$ F capacitors to the AGND.
16	O	OUTL-	Left Channel Negative line level analog output.
17	O	OUTL+	Left Channel Positive line level analog output.
18	I	AVDD	Analog Power Supply. Connect to analog 5 V supply.
19	O	FILTB	Filter Capacitor connection, connect 10 $\mu$ F capacitor to AGND.
20	I	IDPM1	Input serial data port mode control one. With IDPM0, defines one of four serial modes.
21	I	IDPM0	Input serial data port mode control zero. With IDPM1, defines one of four serial modes.
22	O	ZEROL	Left Channel Zero Flag Output. This pin goes HI when Left Channel has no signal input for more than 1024 LR Clock Cycles.
23	I	MUTE	Mute. Assert HI to mute both stereo analog outputs. Deassert LO for normal operation.
24	I	$\overline{PD/RST}$	Power-Down/Reset. The AD1854 is placed in a low power consumption mode when this pin is held LO. The AD1854 is reset on the rising edge of this signal. The serial control port registers are reset to the default values. Connect HI for normal operation.
25	I	$\overline{L/R}CLK$	Left/Right clock input for input data. Must run continuously.
26	I	BCLK	Bit clock input for input data. Need not run continuously; may be gated or used in a burst fashion.
27	I	SDATA	Serial input, MSB first, containing two channels of 16, 18, 20, and 24 bits of twos complement data per channel.
28	I	DVDD	Digital Power Supply Connect to digital 5 V supply.

# AD1854

## OPERATING FEATURES

### Serial Data Input Port

The AD1854's flexible serial data input port accepts data in two's-complement, MSB-first format. The left channel data field always precedes the right channel data field. The input data consists of either 16, 18, 20, or 24 bits, as established by the mode select pins (IDPM0 Pin 21 and IDPM1 Pin 20) or the mode select bits (Bits 15 and 14) in the control register through the SPI (Serial Peripheral Interface) control port. Neither the pins nor the SPI controls has preference; to ensure proper control, the selection not being used should be tied LO. Therefore, when the SPI bits are used to control Serial Data Input Format, Pins 20 and 21 should be tied LO. Similarly, when the pins are to be used to select the Data Format, the SPI bits should be set to zeros. When the SPI Control Port is not being used, the SPI Pins (3, 4, and 5) should be tied LO.

### Serial Data Input Mode

The AD1854 uses two multiplexed input pins to control the mode configuration of the input data port mode as follows:

**Table I. Serial Data Input Modes**

IDPM1 (Pin 20)	IDPM0 (Pin 21)	Serial Data Input Format
0	0	Right Justified (16 Bits)
0	1	I <sup>2</sup> S-Compatible
1	0	Right Justified (20 Bits)
1	1	Right Justified (24 Bits)
Bit Clock	0	Left Justified

Figure 1 shows the right-justified mode (16-bit mode).  $L/\overline{R}CLK$  is HI for the left channel, LO for the right channel. Data is valid on the rising edge of BCLK. The MSB is delayed 16-bit clock periods from an  $L/\overline{R}CLK$  transition, so that when there are 64 BCLK periods per  $L/\overline{R}CLK$  period, the LSB of the data will be right justified to the next  $L/\overline{R}CLK$  transition. The right-justified mode can also be used with 20-bit or 24-bit inputs as selected in Table I.

Figure 2 shows the I<sup>2</sup>S-justified mode.  $L/\overline{R}CLK$  is LO for the left channel and HI for the right channel. Data is valid on the rising edge of BCLK. The MSB is left justified to an  $L/\overline{R}CLK$  transition but with a single BCLK period delay. The I<sup>2</sup>S-justified mode can be used with 16-/18-/20- or 24-bit inputs.

Figure 3 shows the left-justified mode. *Note: Left-justified mode is selected by pulsing IDPM1 (Pin 20) with bit clock, that is, tying bit clock to IDPM1 while IDPM0 (Pin 21) is tied LO. Left-justified can only be selected this way, it cannot be selected through SPI Control Port.*

$L/\overline{R}CLK$  is HI for the left channel, and LO for the right channel. Data is valid on the rising edge of BCLK. The MSB is left-justified to an  $L/\overline{R}CLK$  transition, with no MSB delay. The left-justified mode can be used with 16-/18-/20- or 24-bit inputs.

Note that the AD1854 is capable of a  $32 \times F_S$  BCLK frequency "packed mode" where the MSB is left-justified to an  $L/\overline{R}CLK$  transition, and the LSB is right-justified to an  $L/\overline{R}CLK$  transition.  $L/\overline{R}CLK$  is HI for the left channel, and LO for the right channel. Data is valid on the rising edge of BCLK. Packed mode can be used when the AD1854 is programmed in right-justified mode. Packed mode is shown in Figure 4.

**Table II. Frequency Mode Settings**

$F_S$	96/48	MCLK	X2MCLK	384/256	Note
Normal, 32 kHz–48 kHz	0	$256 \times F_S$	0	0	Not Allowed
Normal, 32 kHz–48 kHz	0	$384 \times F_S$	0	1	
Normal, 32 kHz–48 kHz	0	$512 \times F_S$	1	0	
Normal, 32 kHz–48 kHz	0		1	1	
Double $F_S$ (96 kHz)	1	$128 \times F_S$	0	0	Not Allowed
Double $F_S$ (96 kHz)	1	$(384/2) \times F_S$	0	1	
Double $F_S$ (96 kHz)	1	$256 \times F_S$	1	0	
Double $F_S$ (96 kHz)	1		1	1	

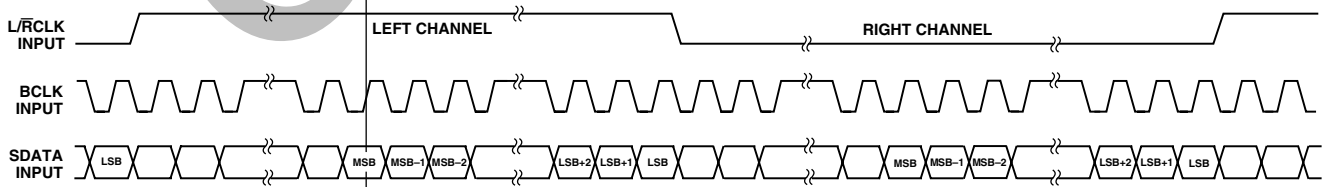

Figure 1. Right-Justified Mode

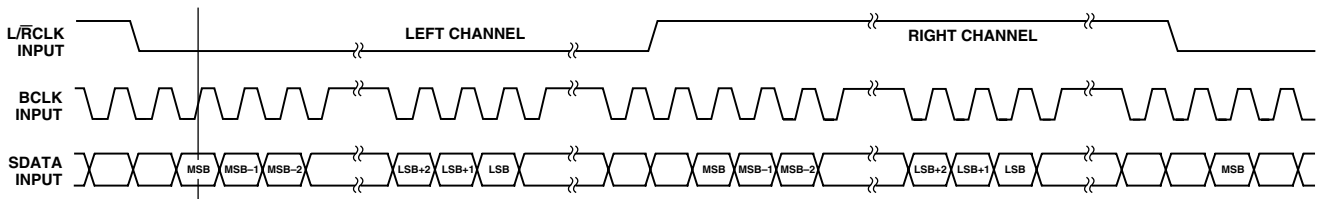

Figure 2. I<sup>2</sup>S-Justified Mode

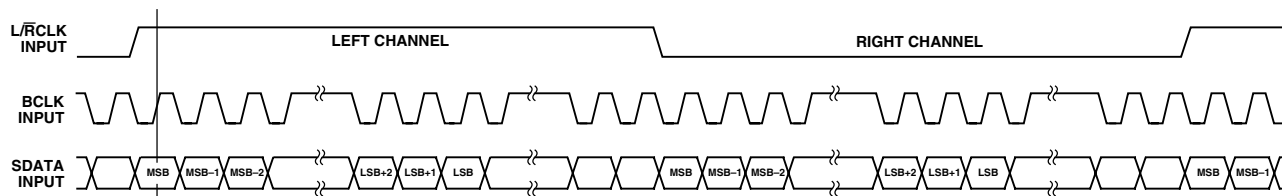

Figure 3. Left-Justified Mode

Figure 4.  $32 \times F_s$  Packed Mode

Figure 5. Serial Control Port Timing

### Serial Control Port

The AD1854 serial control port is SPI-compatible. SPI (Serial Peripheral Interface) is an industry standard serial port protocol. The write-only serial control port gives the user access to: select input mode, soft power-down control, soft de-emphasis, channel-specific attenuation and mute (both channels at once). The AD1854 serial control port consists of three signals, control clock CCLK (Pin 4), control data CDATA (Pin 5), and control latch CLATCH (Pin 3). The control data input must be valid on the control clock rising edge, and the control clock must make a LO to HI transition when there is valid data. The control latch must make a LO-to-HI transition after the LSB has been clocked into the AD1854, while the control clock is inactive. The timing relation between these signals is shown in Figure 5. The control bits are assigned as in Table IV.

Table III. Digital Timing

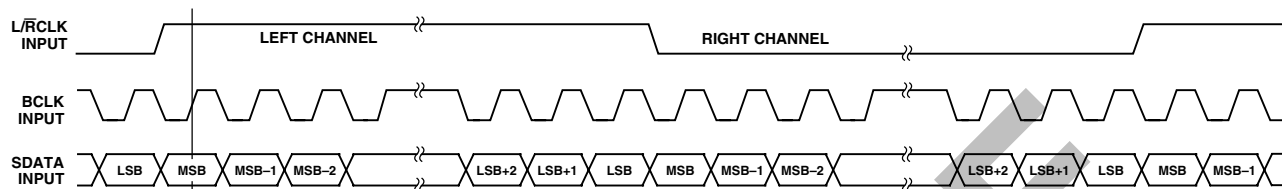
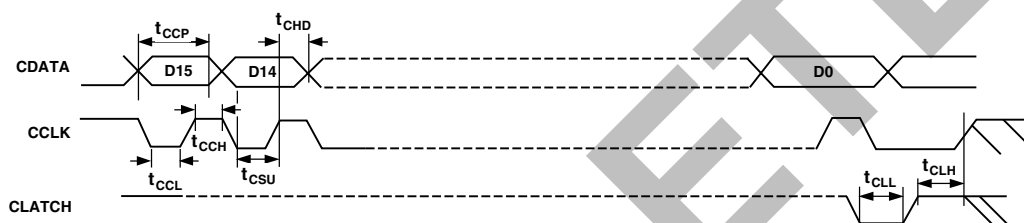
		Min	Unit
$t_{CCH}$	CCLK HI Pulsewidth	40 (Burst Mode)	ns
$t_{CCL}$	CCLK LO Pulsewidth	40 (Burst Mode)	ns
$t_{CCP}$	CCLK Period	80 (Burst Mode)	ns
$t_{CSU}$	CDATA Setup Time	10	ns
$t_{CHD}$	CDATA Hold Time	10	ns
$t_{CCLL}$	CLATCH LO Pulsewidth	10	ns
$t_{CLH}$	CLATCH HI Pulsewidth	130 (Burst Mode)	ns

The serial control port is byte oriented. The data is MSB first, and is unsigned. There is one control register for the left channel or the right channel, as distinguished by Bit Data 10. For power-up and reset, the default settings are: Data 11 the mute control bit, reset default state is LO, which is the normal (nonmuted) setting. Data 10 is LO, the Volume 9 through Volume 0 control bits have a reset default value of 11 1111 1111, which is an attenuation of 0.0 dB (i.e., full scale, no attenuation). The intent with these reset defaults is to enable AD1854 applications without requiring the use of the serial control port. For those users who do not use the serial control port, it is still possible to mute the AD1854 output by using the MUTE (Pin 23) signal.

Note that the serial control port timing is asynchronous to the serial data port timing. Changes made to the attenuator level will be updated on the next edge of the  $L/\bar{R}CLK$  after the CLATCH write pulse as shown in Figure 8.

The SPI port can be used in either of two modes, Burst Mode, or Continuous CCLK Mode, as described below.

### Continuous CCLK Mode

In this mode, the maximum CCLK frequency is 3 MHz. The CCLK can run continuously between transactions. Please note that the LO-to-HI transition of the CLATCH with respect to the rising edge of CCLK must be at least 130 ns, as shown in Figure 6.

Table IV. Serial Control Bit Definitions

MSB	Data 15	Data 14	Data 13	Data 12	Data 11	Data 10	Data 9	Data 8	Data 7	Data 6	Data 5	Data 4	Data 3	Data 2	Data 1	LSB
	Data 15	Data 14	Data 13	Data 12	Data 11	Data 10	Data 9	Data 8	Data 7	Data 6	Data 5	Data 4	Data 3	Data 2	Data 1	Data 0
IDPM1 Input Mode1 Select	IDPM0 Input Mode0 Select	Soft Power- Down	Soft De- Emphasis	1/Mute 0/Normal (Nonmute)	1/Right 0/Left	Volume Control Data	Volume Control Data	Volume Control Data	Volume Control Data	Volume Control Data	Volume Control Data	Volume Control Data	Volume Control Data	Volume Control Data	Volume Control Data	Volume Control Data

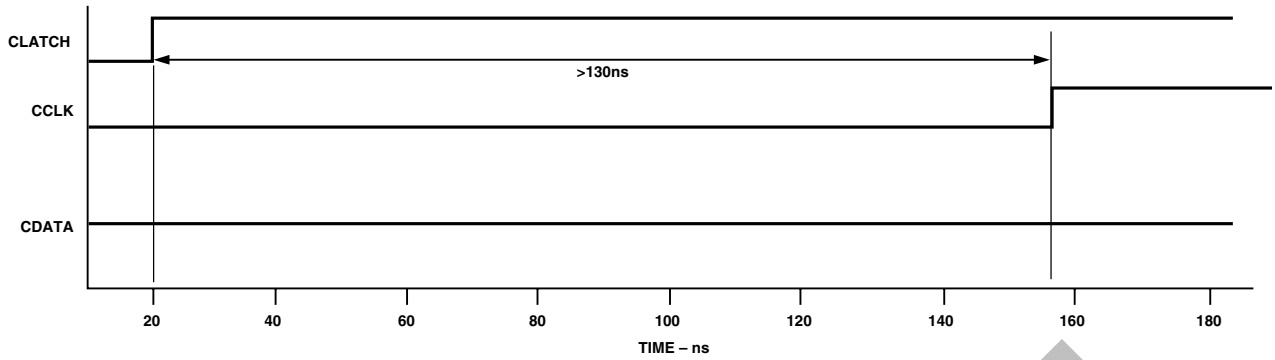

Figure 6. SPI Port Continuous CCLK Mode

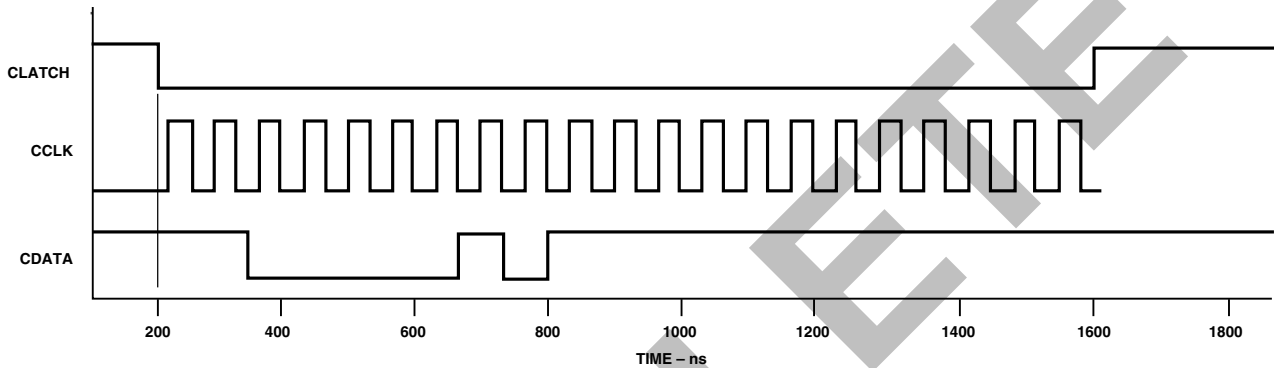

Figure 7. SPI Port Burst Mode

### Burst Mode

To operate with SPI CCLK frequencies up to 12.288 MHz, the SPI port can be operated in Burst Mode. This means that when CLATCH is high, CCLK cannot be HI, as shown in Figure 7.

### Mute

The AD1854 offers two methods of muting the analog output. By asserting the MUTE (Pin 23) signal HI, both the left and right channel are muted. As an alternative, the user can assert the mute bit in the serial control register (Data 11) HI. The AD1854 has been designed to minimize pops and clicks when muting and unmuting the device.

### Smooth Volume Control with Auto Ramp Up/Down

The AD1854 incorporates ADI's 1024 step "Smooth Volume Control" with auto ramp up/down. Once per  $L/\bar{R}CLK$  cycle, the AD1854 compares current volume level register to the volume level request register Data 9:0. If different, volume is adjusted one step/sample. Therefore, a change from max to min volume takes 1024 samples or about 20 ms as shown in Figure 8.

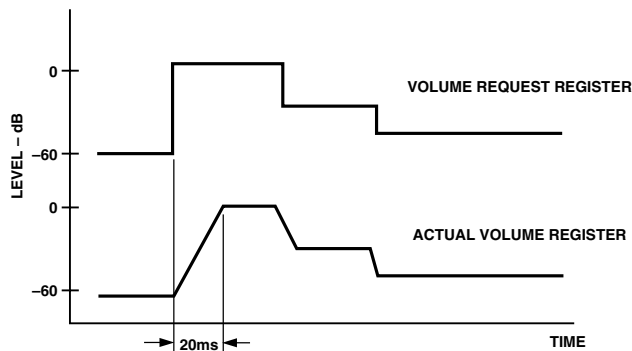

Figure 8. Smooth Volume Control

### Output Drive, Buffering and Loading

The AD1854 analog output stage is able to drive a 1 k $\Omega$  (in series with 2 nF) load.

### Power-Down Reset

The AD1854 offers two methods for power-down and reset. When the  $\overline{PD/RST}$  input (Pin 24) is asserted LO, the AD1854 is reset. As an alternative, the user can assert the soft power-down bit (Data 13) HI. All the registers in the AD1854 digital engine (serial data port, interpolation filter and modulator) are zeroed. The two 8-bit registers in the serial control port are initialized back to their default values. The user should wait 100 ms after bringing  $\overline{PD/RST}$  HI before using the serial data input port and the serial control input. The AD1854 is designed to minimize pops and clicks when entering and exiting the power-down state.

### De-Emphasis

The AD1854 offers digital de-emphasis, supporting 50  $\mu$ s/15  $\mu$ s digital de-emphasis intended for "Redbook" 44.1 kHz sample frequency playback from Compact Discs. The AD1854 offers control of de-emphasis by asserting the DEEMP input (Pin 9) HI or by asserting the de-emphasis register bit (Data 12) HI. The AD1854's de-emphasis is optimized for 44.1 kHz but will scale to the other sample frequencies.

### Control Signals

The IDPM0, IDPM1, and DEEMP control inputs are normally connected HI or LO to establish the operating state of the AD1854. They can be changed dynamically (and asynchronously to  $L/\bar{R}CLK$  and the master clock) as long as they are stable before the first serial data input bit (i.e., MSB) is presented to the AD1854.

**Timing Diagrams**

The serial data port timing is shown in Figures 9 and 10. The minimum bit clock HI pulsewidth is  $t_{DBH}$  and the minimum bit clock LO pulsewidth is  $t_{DBL}$ . The minimum bit clock period is  $t_{DBP}$ . The left/right clock minimum setup time is  $t_{DLS}$  and the left/right clock minimum hold time is  $t_{DLH}$ . The serial data

minimum setup time is  $t_{DDS}$  and the minimum serial data hold time is  $t_{DDH}$ .

The power-down/reset timing is shown in Figure 11. The minimum reset LO pulse width is  $t_{PDRP}$  (four MCLK periods) to accomplish a successful AD1854 reset operation.

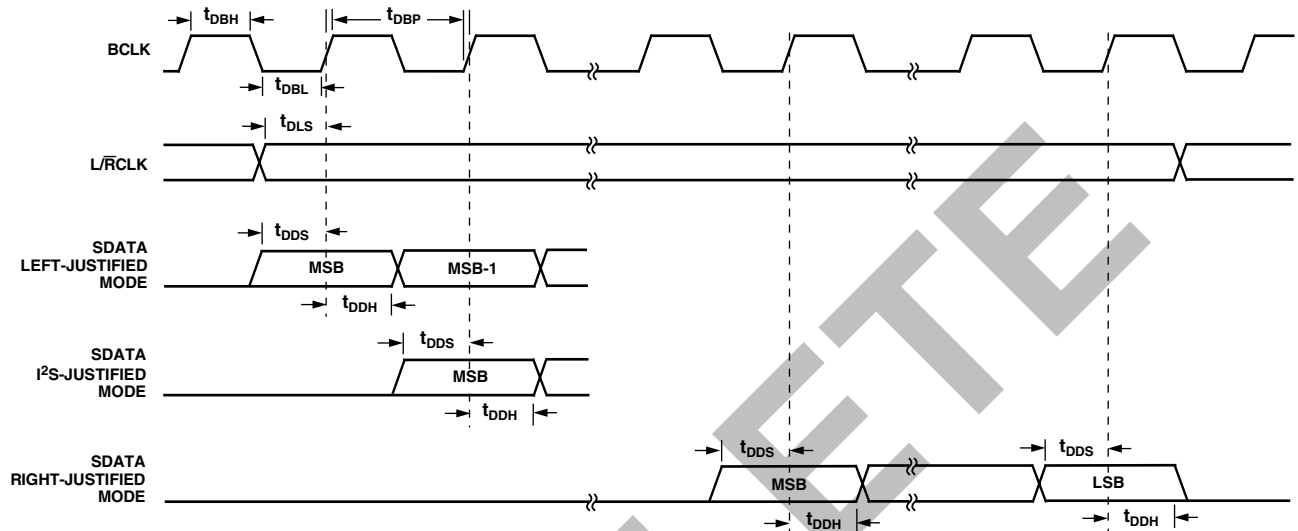

Figure 9. Serial Data Port Timing

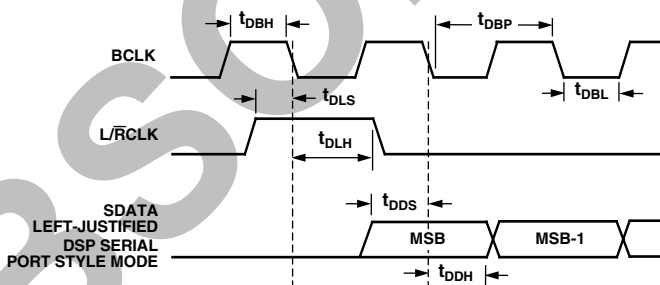

Figure 10. Serial Data Port Timing—DSP Serial Port Style Mode

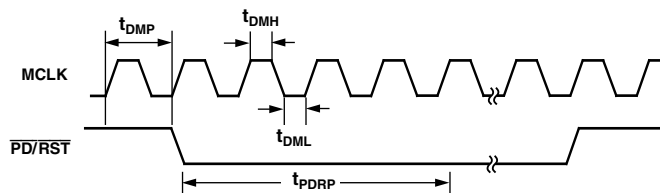

Figure 11. Power-Down/Reset Timing

# AD1854

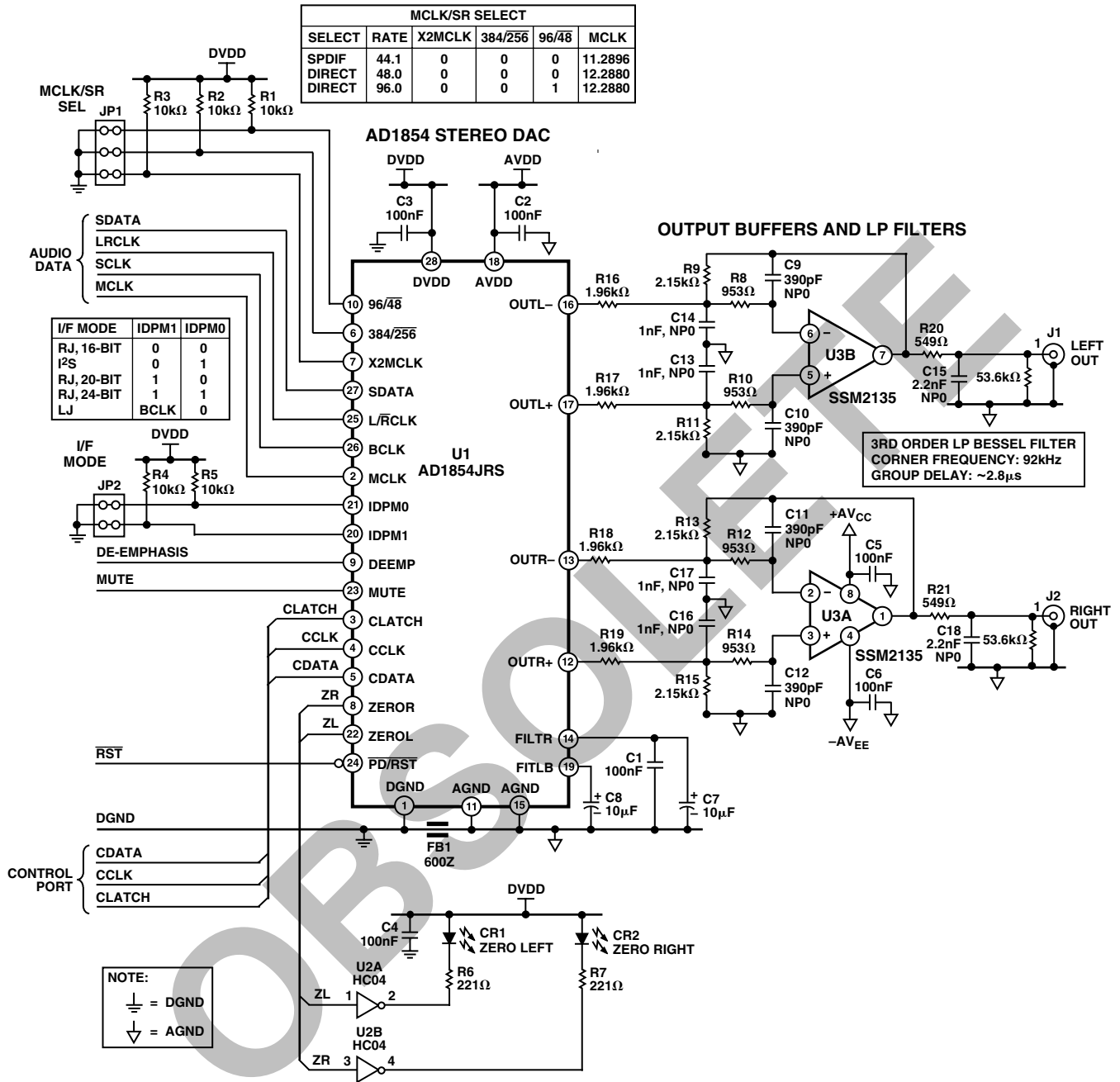

Figure 12. Evaluation Board Circuit

## TYPICAL PERFORMANCE

Figures 13 through 20 illustrate the typical analog performance of the AD1854 as measured by an Audio Precision System Two. Signal-to-Noise and THD+N performance are shown under a range of conditions. Figure 14 shows the power supply rejection

performance of the AD1854. Figure 15 shows the noise floor of the AD1854. The digital filter transfer function is shown in Figure 16. The two-tone test in Figure 17 is per the SMPTE Standard for Measuring Intermodulation Distortion.

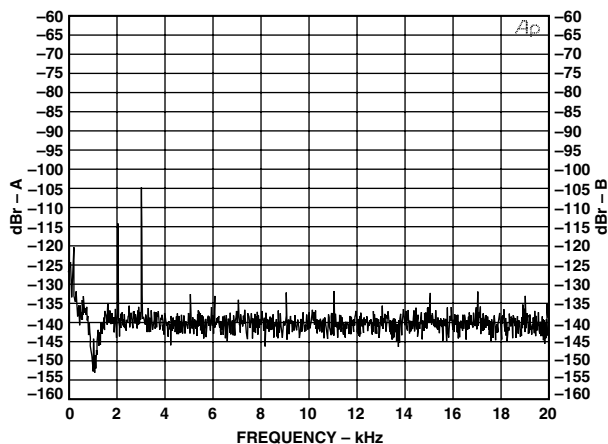

Figure 13. THD+N at 1 kHz, -0.5 dBFS (8K-Point FFT)

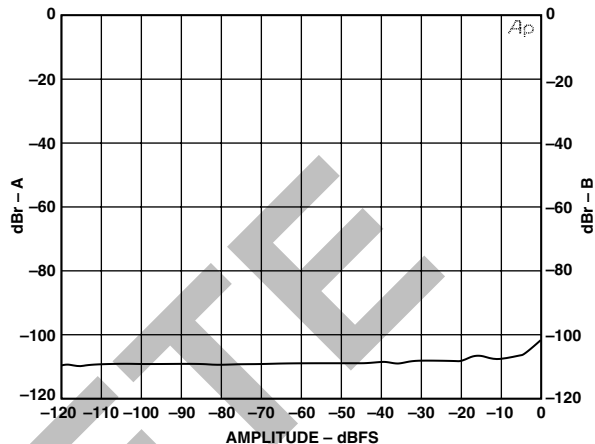

Figure 16. THD+N vs. Level at 1 kHz

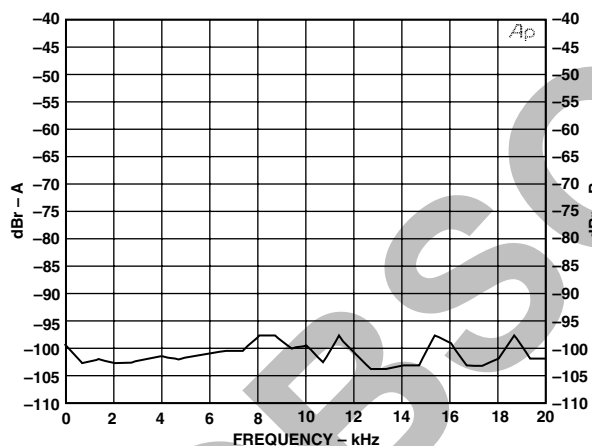

Figure 14. THD+N vs. Frequency at -0.5 dBFS

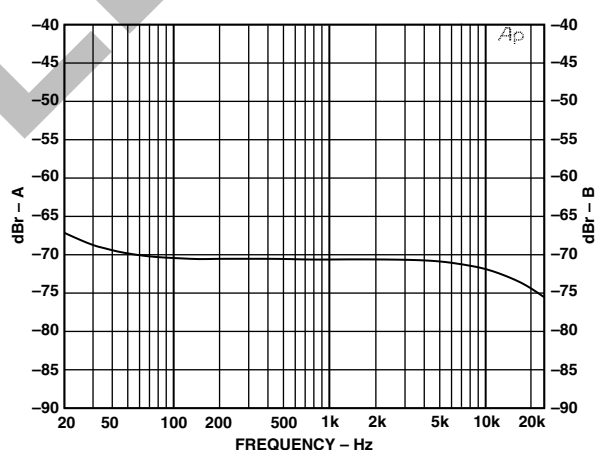

Figure 17. Power Supply Rejection to 300 mV p-p on AVDD

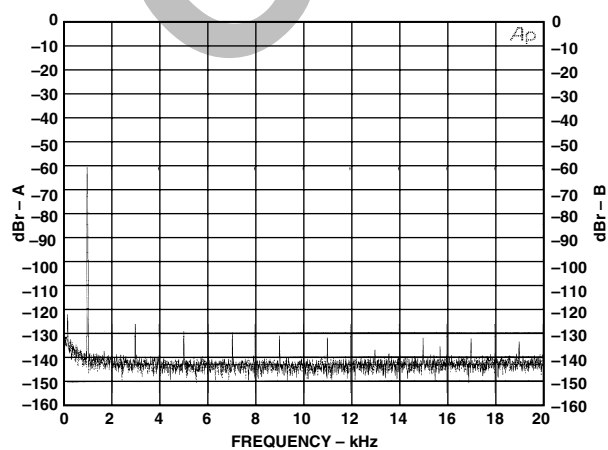

Figure 15. Dynamic Range: 1 kHz at -60 dBFS (8K Point FFT)

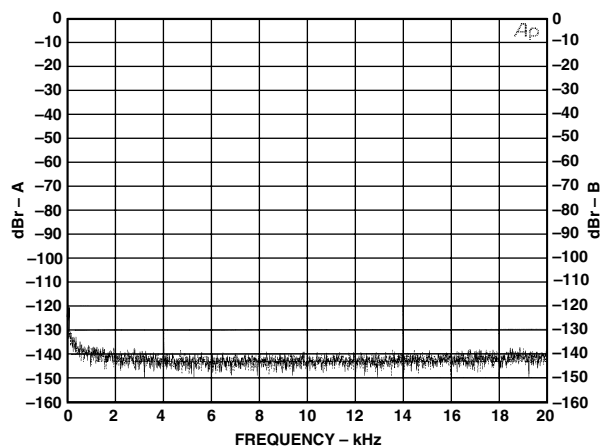

Figure 18. Noise Floor, A-Weighted (8K-Point FFT)

# AD1854

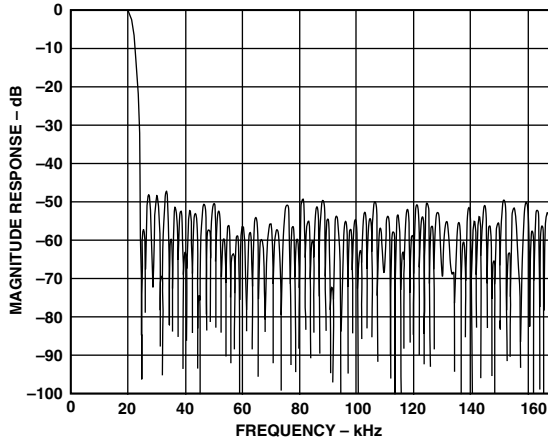

Figure 19. Digital Filter Response

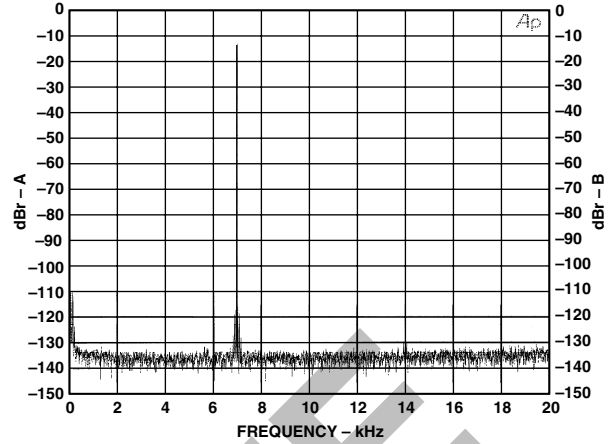
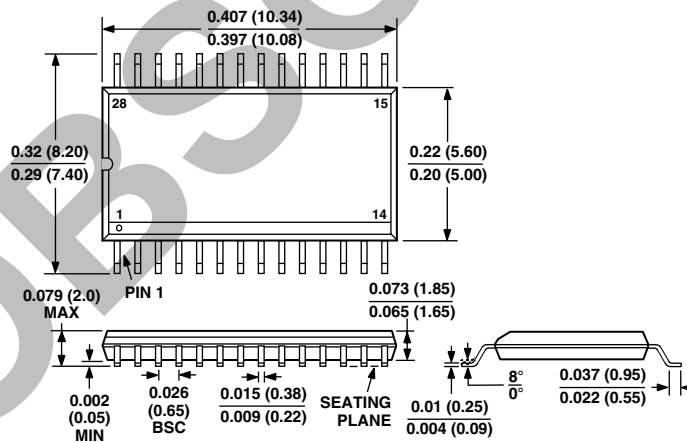

Figure 20. Two-Tone Test

## OUTLINE DIMENSIONS

Dimensions shown in inches and (mm).

### 28-Lead Shrink Small Outline Package (SSOP) (RS-28)



## Looking for pricing, stock, or lifecycle information?

Click below to explore more details on WIN SOURCE:

 [View AD1854JRSZRL on WIN SOURCE](#)

 [Analog Devices Inc. Information](#)

## Optimize Your Supply Chain with WIN SOURCE Solutions

-  Global Sourcing Solution
-  Obsolete Management
-  Cost Control Management
-  Shortage Management
-  Alternative Solution
-  Excess Inventory Management