



**THE DATASHEET OF
PVZ2A303A01R00**



Trimmer Potentiometers



SMD Open Type 2mm Size PVZ2 Series

■ Features

1. Ultra-small and thin external dimensions of 2.1(W)x2.7(L)x0.85 max. (T)mm. (PVZ2A_A04 Series)
2. Au plated termination achieves a high density P.C.B. mounting.
3. Cross-shaped driver slot allows for in-process automatic adjustment and it provides superior adjustability.
4. Two-piece parts construction achieves low cost and excellent quality.
5. Special resin substrate allows high peak temperature for reflow soldering.

■ Applications

- | | |
|-------------------|-------------------------|
| 1. Pick-up module | 2. LCD |
| 3. Cellular-phone | 4. PHS |
| 5. Pager | 6. DVC |
| 7. Digital camera | 8. Portable audio, etc. |



PVZ2A

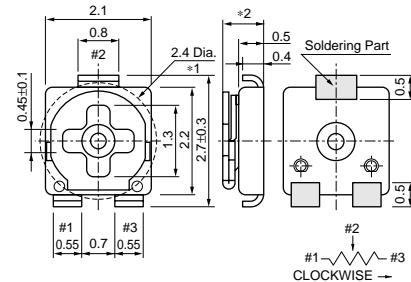

*1 Driver Plate Rotation Area :
Please do not place any components more than 0.7mm in height within this area.
*2 PVZ2A_A01 : 0.9±0.1
PVZ2A_A04 : 0.8±0.05
(Tolerance : ±0.2) in mm



PVZ2K

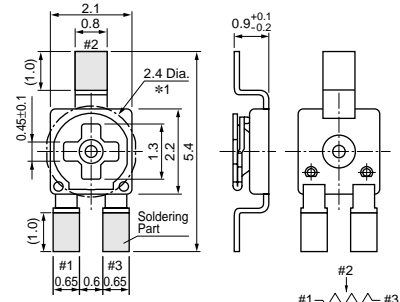

*1. Driver Plate Rotation Area :
Please do not place any components more than 0.7mm in height within this area.
(Tolerance : ±0.2) in mm

Part Number	Power Rating	Soldering Method	Number of Turns (Effective Rotation Angle)	Total Resistance Value	TCR
PVZ2□501A01	0.1W(50°C)	Reflow/Soldering Iron	1(240°±10°)	500ohm ±30%	±500ppm/°C
PVZ2□102A01	0.1W(50°C)	Reflow/Soldering Iron	1(240°±10°)	1k ohm ±30%	±500ppm/°C
PVZ2□202A01	0.1W(50°C)	Reflow/Soldering Iron	1(240°±10°)	2k ohm ±30%	±500ppm/°C
PVZ2□302A01	0.1W(50°C)	Reflow/Soldering Iron	1(240°±10°)	3k ohm ±30%	±500ppm/°C
PVZ2□502A01	0.1W(50°C)	Reflow/Soldering Iron	1(240°±10°)	5k ohm ±30%	±500ppm/°C
PVZ2□103A01	0.1W(50°C)	Reflow/Soldering Iron	1(240°±10°)	10k ohm ±30%	±500ppm/°C
PVZ2□203A01	0.1W(50°C)	Reflow/Soldering Iron	1(240°±10°)	20k ohm ±30%	±500ppm/°C
PVZ2□303A01	0.1W(50°C)	Reflow/Soldering Iron	1(240°±10°)	30k ohm ±30%	±500ppm/°C
PVZ2□503A01	0.1W(50°C)	Reflow/Soldering Iron	1(240°±10°)	50k ohm ±30%	±500ppm/°C
PVZ2□104A01	0.1W(50°C)	Reflow/Soldering Iron	1(240°±10°)	100k ohm ±30%	±500ppm/°C
PVZ2□204A01	0.1W(50°C)	Reflow/Soldering Iron	1(240°±10°)	200k ohm ±30%	±500ppm/°C
PVZ2□304A01	0.1W(50°C)	Reflow/Soldering Iron	1(240°±10°)	300k ohm ±30%	±500ppm/°C
PVZ2□504A01	0.1W(50°C)	Reflow/Soldering Iron	1(240°±10°)	500k ohm ±30%	±500ppm/°C
PVZ2□105A01	0.1W(50°C)	Reflow/Soldering Iron	1(240°±10°)	1M ohm ±30%	±500ppm/°C
PVZ2□501A04	0.1W(50°C)	Reflow/Soldering Iron	1(240°±10°)	500ohm ±30%	±500ppm/°C
PVZ2□102A04	0.1W(50°C)	Reflow/Soldering Iron	1(240°±10°)	1k ohm ±30%	±500ppm/°C
PVZ2□202A04	0.1W(50°C)	Reflow/Soldering Iron	1(240°±10°)	2k ohm ±30%	±500ppm/°C
PVZ2□302A04	0.1W(50°C)	Reflow/Soldering Iron	1(240°±10°)	3k ohm ±30%	±500ppm/°C
PVZ2□502A04	0.1W(50°C)	Reflow/Soldering Iron	1(240°±10°)	5k ohm ±30%	±500ppm/°C
PVZ2□103A04	0.1W(50°C)	Reflow/Soldering Iron	1(240°±10°)	10k ohm ±30%	±500ppm/°C
PVZ2□203A04	0.1W(50°C)	Reflow/Soldering Iron	1(240°±10°)	20k ohm ±30%	±500ppm/°C
PVZ2□303A04	0.1W(50°C)	Reflow/Soldering Iron	1(240°±10°)	30k ohm ±30%	±500ppm/°C
PVZ2□503A04	0.1W(50°C)	Reflow/Soldering Iron	1(240°±10°)	50k ohm ±30%	±500ppm/°C
PVZ2□104A04	0.1W(50°C)	Reflow/Soldering Iron	1(240°±10°)	100k ohm ±30%	±500ppm/°C
PVZ2□204A04	0.1W(50°C)	Reflow/Soldering Iron	1(240°±10°)	200k ohm ±30%	±500ppm/°C

Continued on the following page.

Continued from the preceding page.

1

Part Number	Power Rating	Soldering Method	Number of Turns (Effective Rotation Angle)	Total Resistance Value	TCR
PVZ2□304A04	0.1W(50°C)	Reflow/Soldering Iron	1(240°±10°)	300k ohm ±30%	±500ppm/°C
PVZ2□504A04	0.1W(50°C)	Reflow/Soldering Iron	1(240°±10°)	500k ohm ±30%	±500ppm/°C
PVZ2□105A04	0.1W(50°C)	Reflow/Soldering Iron	1(240°±10°)	1M ohm ±30%	±500ppm/°C

The blank column is filled with the code of adjustment direction A (top) or K (rear).

Construction

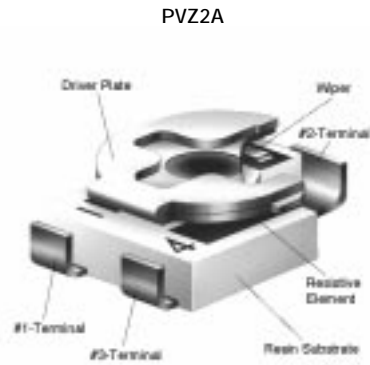

Standard Land Pattern

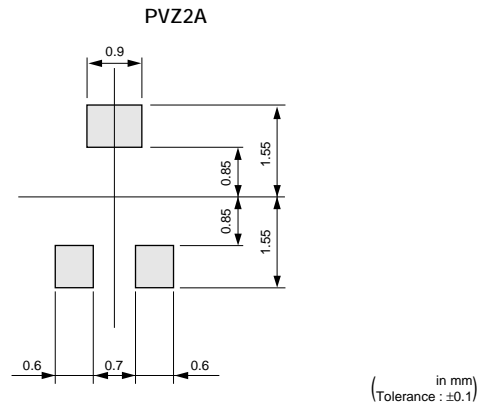

Construction

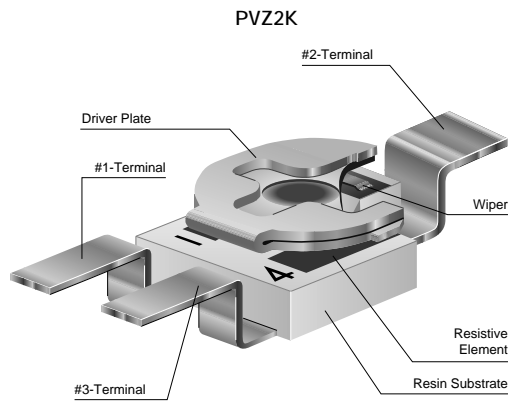

Standard Land Pattern

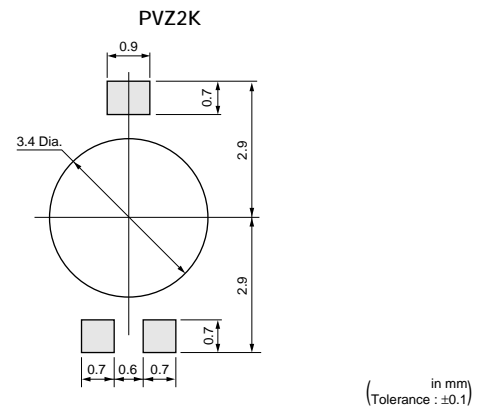

Characteristics

Humidity Exposure	Res. Change : +10, -2%
High Temperature Exposure	Res. Change : $R \leq 50\text{kohm} \dots +2, -10\%$ $50\text{kohm} < R \dots +2, -15\%$
Humidity Load Life	Res. Change : ±10%
Load Life	Res. Change : $R \leq 50\text{kohm} \dots +2, -10\%$ $50\text{kohm} < R \dots +2, -15\%$
Temperature Cycle	Res. Change : ±5%
Temperature Coefficient of Resistance	±500ppm/°C
Rotational Life	Res. Change : ±10% (10 cycles)

■ Notice (Operating and Storage Conditions)

1. Store in temperatures of -10 to +40 deg. C and relative humidity of 30-85%RH.
2. Do not store in or near corrosive gases.
3. Use within six months after delivery.
4. Open the package just before using.
5. Do not store under direct sunlight.
6. If you use the trimmer potentiometer in an environment other than listed below, please consult with a Murata factory representative prior to using.
The trimmer potentiometer should not be used under

the following environmental conditions:

- (1) Corrosive gaseous atmosphere
(Ex. Chlorine gas, Hydrogen sulfide gas, Ammonia gas, Sulfuric acid gas, Nitric oxide gas, etc.)
- (2) In liquid
(Ex. Oil, Medical liquid, Organic solvent, etc.)
- (3) Dusty / dirty atmosphere
- (4) Direct sunlight
- (5) Static voltage nor electric/magnetic fields
- (6) Direct sea breeze
- (7) Other variations of the above

■ Notice (Rating)

1. When using with partial load (rheostat), minimize the power depending on the resistance value.
2. The maximum input voltage to a trimmer potentiometer should not exceed $(P \cdot R)^{1/2}$ or the maximum operating voltage, whichever is smaller.
3. The maximum input current to a trimmer potentiometer should not exceed $(P/R)^{1/2}$ or the allowable wiper current, whichever is smaller.
4. If the trimmer potentiometer is used in DC and high humidity conditions, please connect wiper (#2) for plus and resistive element (#1 or #3) for minus.

■ Notice (Soldering and Mounting)

1. Soldering
 - (1) Reflow soldering and Soldering Iron are available. Cannot be soldered using the flow soldering method. If you use the flow soldering method, the trimmer potentiometer may not function.
 - (2) Use our standard land dimension. Excessive land area causes displacement due to the effect of the surface tension of the solder. Insufficient land area leads to insufficient soldering strength of the chip.
 - (3) Standard soldering condition
 - (a) Reflow soldering :
Refer to the standard temperature profile.
 - (b) Soldering iron:
 - >Temperature of tip 360 deg. C max.
 - >Soldering time 3 sec. max.
 - >Diameter 1mm max.
 - >Wattage of iron 30W max.
- Before using other soldering conditions than those listed above, please consult with Murata factory representative prior to using. If the soldering conditions are not suitable, e.g., excessive time and/or excessive temperature, the trimmer potentiometer may deviate from the specified characteristics.
- (4) Apply the appropriate amount of solder paste.

The thickness of solder paste should be printed from 100 micro m to 150 micro m and the dimension of land pattern used should be Murata's standard land pattern at reflow soldering. Insufficient amounts of solder can lead to insufficient soldering strength on PCB. Excessive amounts of solder may cause bridging between the terminals.

- (5) The soldering iron should not come in contact with the case of the trimmer potentiometer. If such contact does occur, the trimmer potentiometer may be damaged.

2. Mounting

- (1) Do not apply excessive force (preferably 4.9N (Ref.; 500gf) max.), when the trimmer potentiometer is mounted to the PCB.
- (2) Do not warp and/or bend PC board to prevent trimmer potentiometer from breakage.
- (3) In chip placers, the recommended size of the cylindrical pick-up nozzle should be outer dimension 1.5-1.8mm dia. and inner dimension 1.3mm dia.

3. Cleaning

- (1) In case there is flux on the resistive element, clean sufficiently with cleaning solvents and completely remove all residual flux.
- (2) Isopropyl-alcohol and Ethyl-alcohol are

Continued on the following page. 

PVZ2 Series Notice

Continued from the preceding page.

applicable solvents for cleaning. If you use any other types of solvents, please evaluate

performance by your product.

Reflow Soldering Standard Profile

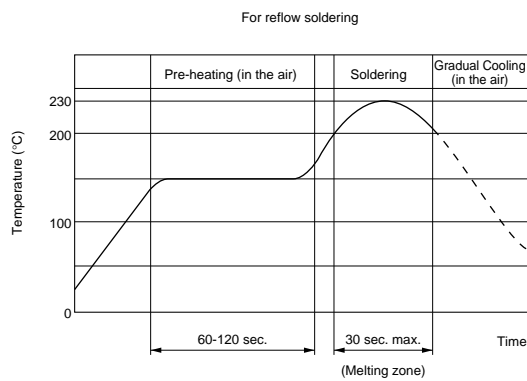

Notice (Handling)

- Use suitable screwdrivers that fit comfortably in driver slot. We recommend the screwdriver below.
* Recommended screwdriver for manual adjustment
PVZ2A_A01=Murata P/N : KMDR090
PVZ2A_A04=Murata P/N : KMDR150
- Don't apply more than 4.9N (Ref.: 500gf) of twist and stress after mounting onto PCB to prevent contact intermittence. If excessive force is applied, the trimmer potentiometer may not function.

- Please use within the effective rotational angle.
The potentiometer does not have a mechanical stop for over rotation. In cases out of effective rotational angle, the trimmer potentiometer may not function.
- When using a lock paint to fix slot position, please consult with a Murata factory representative prior to using to prevent corrosion and contact intermittence.

Notice (Other)

- Please make sure that your product has been evaluated and confirmed against your specifications when our product is mounted to your product.
- Murata cannot guarantee trimmer potentiometer integrity when used under conditions other than those specified in this document.

SMD Open Type and SMD Sealed Type PVM4A_C01 Series Specifications and Test Methods

The tests and measurements should be conducted under the condition of 15 to 35°C of temperature, 25 to 75% of relative humidity and 86 to 106 kpa of atmospheric pressure unless otherwise specified. If questionable results occur that have been measured in accordance with the above mentioned conditions, the tests and measurements should be conducted under the condition of 25±2°C of temperature and, 45 to 55% of relative humidity and 86 to 106 kpa of atmospheric pressure.

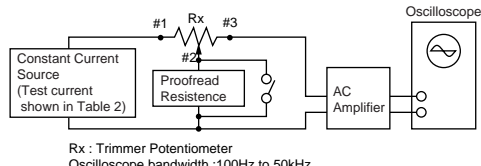
No.	Item	Test Methods																														
1	Total Resistance	<p>Measure total resistance between the resistance element and terminals (terminals #1 and #3) with the contact arm positioned against a stop. The positioning of the contact arm and terminal should be the same for subsequent total resistance measurements on the same device.</p> <p>Use the test voltage specified in Table-1 for total resistance measurements. This voltage should be used whenever a subsequent total resistance measurement is made.</p> <table border="1"> <thead> <tr> <th>Total Resistance, Nominal (ohm)</th> <th>Maximum Test Voltage (V)</th> </tr> </thead> <tbody> <tr> <td>10≤R≤100</td> <td>1.0</td> </tr> <tr> <td>100<R≤1k</td> <td>3.0</td> </tr> <tr> <td>1k<R≤10k</td> <td>10.0</td> </tr> <tr> <td>10k<R≤100k</td> <td>30.0</td> </tr> <tr> <td>100k<R</td> <td>100.0</td> </tr> </tbody> </table> <p>Table 1: Total resistance test voltage</p>	Total Resistance, Nominal (ohm)	Maximum Test Voltage (V)	10≤R≤100	1.0	100<R≤1k	3.0	1k<R≤10k	10.0	10k<R≤100k	30.0	100k<R	100.0																		
Total Resistance, Nominal (ohm)	Maximum Test Voltage (V)																															
10≤R≤100	1.0																															
100<R≤1k	3.0																															
1k<R≤10k	10.0																															
10k<R≤100k	30.0																															
100k<R	100.0																															
2	Residual Resistance	<p>Position the contact arm at the extreme counterclockwise limit of mechanical travel and measure the resistance between the contact arm and the corresponding end terminal. Then, position the contact arm at the extreme clockwise limit of mechanical travel and measure the resistance between the contact arm and the corresponding end terminal. During this test, take suitable precautions to ensure that the rated current of the resistance element is not exceeded.</p>																														
3	Contact Resistance	<p>Contact resistance variation should be measured with the measuring circuit shown below, or its equivalent. The operating wiper should be rotated in both directions through 90% of the actual effective-electrical travel for a total of 6 cycles.</p> <p>The rate of rotation of the operating wiper should be such that the wiper completes 1 count in determining whether or not a contact resistance variation is observed at least twice in the same location. The test current should follow the value given in Table-2 unless otherwise limited by the power rating.</p> <table border="1"> <thead> <tr> <th>Standard Total Resistance R (ohm)</th> <th>Test Current</th> </tr> </thead> <tbody> <tr> <td>100≤R<10k</td> <td>10mA max.</td> </tr> <tr> <td>10k≤R<100k</td> <td>1mA max.</td> </tr> <tr> <td>100k≤R</td> <td>100μA max.</td> </tr> </tbody> </table> <p>Table 2: Test current for CRV</p>  <p>Rx : Trimmer Potentiometer Oscilloscope bandwidth :100Hz to 50kHz</p> <p>Figure 1: CRV measuring circuit</p>	Standard Total Resistance R (ohm)	Test Current	100≤R<10k	10mA max.	10k≤R<100k	1mA max.	100k≤R	100μA max.																						
Standard Total Resistance R (ohm)	Test Current																															
100≤R<10k	10mA max.																															
10k≤R<100k	1mA max.																															
100k≤R	100μA max.																															
4	Humidity Exposure	<p>The wiper contact point should be preset at about 50% position of effective rotational angle. After that, the potentiometer should be placed in a chamber at 40±2°C and 90 - 95% without loading for 500±12 hours. The resistance value should be measured after keeping the potentiometer in a room for 5±1/6 hours.</p>																														
5	High Temperature Exposure	<p>The wiper contact point should be preset at about 50% position of effective rotational angle. After that, the potentiometer should be placed in a chamber at 70±2°C without loading for 500±12 hours. The resistance value should be measured after keeping the potentiometer in a room for 1.5±1/6 hours.</p>																														
6	Humidity Load Life	<p>The wiper contact point should be preset at about 50% position of effective rotational angle. After that, the potentiometer should be placed in a chamber at 40±2°C and 90 - 95% with loading the 1/2 rated voltage between #1 and #2 terminals, intermittently 1.5 hours ON and 0.5 hours OFF for 1000±12hours. The resistance value should be measured after keeping the potentiometer in a room for 5±1/6 hours.</p>																														
7	Load Life	<p>The wiper contact point should be preset at about 50% position of effective rotational angle. After that, the potentiometer should be placed in a chamber at 70±2°C (50±2°C for PVZ) with loading the 1/2 rated voltage between #1 and #2 terminals, intermittently 1.5 hours ON and 0.5 hours OFF for 1000±12 hours. The resistance value should be measured after keeping the potentiometer in a room for 1.5±1/6 hours.</p>																														
8	Temperature Cycle	<p>The wiper contact point should be preset at about 50% position of effective rotational angle. After that, the potentiometer should be subjected to Table 3, Table 4 temperature for 5 cycles. The resistance value should be measured after keeping the potentiometer in a room for 1.5±10 minutes.</p> <table border="1"> <thead> <tr> <th>Sequence</th> <th>1</th> <th>2</th> <th>3</th> <th>4</th> </tr> </thead> <tbody> <tr> <td>Temp. (°C)</td> <td>-25±3</td> <td>+25±2</td> <td>+85±3</td> <td>+25±2</td> </tr> <tr> <td>Time (min.)</td> <td>30±3</td> <td>10max.</td> <td>30±3</td> <td>10max.</td> </tr> </tbody> </table> <p>Table 3: PVZ</p> <table border="1"> <thead> <tr> <th>Sequence</th> <th>1</th> <th>2</th> <th>3</th> <th>4</th> </tr> </thead> <tbody> <tr> <td>Temp. (°C)</td> <td>-55±3</td> <td>+25±2</td> <td>+125±3</td> <td>+25±2</td> </tr> <tr> <td>Time (min.)</td> <td>30±3</td> <td>10max.</td> <td>30±3</td> <td>10max.</td> </tr> </tbody> </table> <p>Table 4: PVA3/PVS3/PVM4A□□□C01</p>	Sequence	1	2	3	4	Temp. (°C)	-25±3	+25±2	+85±3	+25±2	Time (min.)	30±3	10max.	30±3	10max.	Sequence	1	2	3	4	Temp. (°C)	-55±3	+25±2	+125±3	+25±2	Time (min.)	30±3	10max.	30±3	10max.
Sequence	1	2	3	4																												
Temp. (°C)	-25±3	+25±2	+85±3	+25±2																												
Time (min.)	30±3	10max.	30±3	10max.																												
Sequence	1	2	3	4																												
Temp. (°C)	-55±3	+25±2	+125±3	+25±2																												
Time (min.)	30±3	10max.	30±3	10max.																												

Continued on the following page. 

SMD Open Type and SMD Sealed Type PVM4A_C01 Series Specifications and Test Methods

Continued from the preceding page.

No.	Item	Test Methods																				
9	Temperature Coefficient of Resistance	<p>The trimmer potentiometer should be subjected to each of the following temperatures (see Table 5, Table 6) for 30 to 45 minutes. The resistance value should be measured in the chamber.</p> $TCR = \frac{R_2 - R_1}{R_1 (T_2 - T_1)} \times 10^6 \text{ (ppm/}^\circ\text{C)}$ <p> T₁ : Reference temperature in degrees celsius T₂ : Test temperature in degrees celsius R₁ : Resistance at reference temperature in ohm R₂ : Resistance at test temperature in ohm </p> <table border="1" style="display: inline-table; margin-right: 20px;"> <thead> <tr> <th>Sequence</th> <th>1*</th> <th>2</th> <th>3*</th> <th>4</th> </tr> </thead> <tbody> <tr> <td>Temp. (°C)</td> <td>+25±2</td> <td>-25±3</td> <td>+25±2</td> <td>+85±3</td> </tr> </tbody> </table> <p>Note*: Norm temp.</p> <p style="text-align: center;">Table 5: PVZ</p> <table border="1" style="display: inline-table;"> <thead> <tr> <th>Sequence</th> <th>1</th> <th>2</th> <th>3*</th> <th>4</th> </tr> </thead> <tbody> <tr> <td>Temp. (°C)</td> <td>+25±2</td> <td>-55±3</td> <td>+25±2</td> <td>+125±3</td> </tr> </tbody> </table> <p style="text-align: center;">Table 6: PVA3/PVS3/PVM4A□□□C01</p>	Sequence	1*	2	3*	4	Temp. (°C)	+25±2	-25±3	+25±2	+85±3	Sequence	1	2	3*	4	Temp. (°C)	+25±2	-55±3	+25±2	+125±3
Sequence	1*	2	3*	4																		
Temp. (°C)	+25±2	-25±3	+25±2	+85±3																		
Sequence	1	2	3*	4																		
Temp. (°C)	+25±2	-55±3	+25±2	+125±3																		
10	Rotational Life	<p>The wiper should be rotated over 90% of the effective rotational angle without loading at a speed of 10 cycles per minute, for 10 cycles continuously. The resistance value should be measured after keeping the potentiometer in a room for 10±5 minutes.</p>																				

Looking for pricing, stock, or lifecycle information?

Click below to explore more details on WIN SOURCE:

[View PVZ2A303A01R00 on WIN SOURCE](#)

[Bourns Inc. Information](#)

Optimize Your Supply Chain with WIN SOURCE Solutions

- ✓ Global Sourcing Solution
- ✓ Obsolete Management
- ✓ Cost Control Management
- ✓ Shortage Management
- ✓ Alternative Solution
- ✓ Excess Inventory Management