



**THE DATASHEET OF
F981C105MMA**



F98 Series



Resin-Molded Chip, High CV Undertab



FEATURES

- Compliant to the RoHS2 directive 2011/65/EU
- SMD face down design
- Small and low profile



APPLICATIONS

- Smartphone
- Mobile phone
- Wireless module
- Hearing aid

CASE DIMENSIONS: millimeters (inches)

Code	EIA Code	EIA Metric	L	W ₁	W ₂	H	S ₁	S ₂
M	0603	1608-09	1.60 ^{+0.20} _{-0.10} (0.063 ^{+0.008} _{-0.004})	0.85 ^{+0.20} _{-0.10} (0.033 ^{+0.008} _{-0.004})	0.65±0.10 (0.026±0.004)	0.80±0.10 ^{*3} (0.031±0.004)	0.50±0.10 (0.020±0.004)	0.60±0.10 (0.024±0.004)
S	0805	2012-09	2.00 ^{+0.20} _{-0.10} (0.079 ^{+0.008} _{-0.004})	1.25 ^{+0.20} _{-0.10} (0.049 ^{+0.008} _{-0.004})	0.90±0.10 (0.035±0.004)	0.80±0.10 (0.031±0.004)	0.50±0.10 (0.020±0.004)	1.00±0.10 (0.039±0.004)
U	0402	1106-06	1.10±0.05 (0.043±0.002)	0.60±0.05 (0.024±0.002)	0.35±0.05 (0.014±0.002)	0.55±0.05 (0.022±0.002)	0.30±0.05 (0.012±0.002)	0.50±0.05 (0.020±0.002)

*3 F980J107MMAAXE: 1.0mm Max.

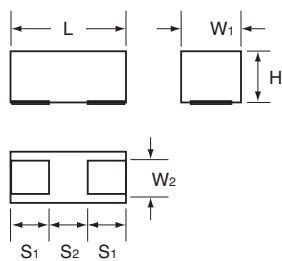

MARKING

U CASE



M CASE

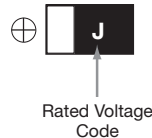

S CASE

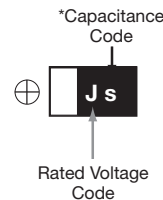

HOW TO ORDER

F98

Type

0J

Rated Voltage

106

Capacitance Code

pF code: 1st two digits represent significant figures, 3rd digit represents multiplier (number of zeros to follow)

M

Tolerance
M = ±20%

M

Case Size
See table above

□

Packaging
See Tape & Reel Packaging Section

□□□

Specification Suffix
LZT = Rated temperature 60°C only
AXE = Rated temperature 60°C and H dimension 1.0mm Max

TECHNICAL SPECIFICATIONS

Category Temperature Range:	-55 to +125°C
Rated Temperature:	+85°C
Capacitance Tolerance:	±20% at 120Hz
Dissipation Factor:	Refer to next page
ESR 100kHz:	Refer to next page
Leakage Current:	Refer to next page Provided that: After 5 minute's application of rated voltage, leakage current at 85°C 10 times or less than 20°C specified value. After 5 minute's application of rated voltage, leakage current at 125°C 12.5 times or less than 20°C specified value.

F98 Series



Resin-Molded Chip, High CV Undertab

CAPACITANCE AND RATED VOLTAGE RANGE (LETTER DENOTES CASE SIZE)

Capacitance		Rated Voltage								*Cap Code
µF	Code	2.5 (0e)	4V (0G)	6.3V (0J)	10V (1A)	16V (1C)	20V (1D)	25V (1E)	35V (1V)	
0.47	474					U				N
1.0	105					M	M	M	S	A
2.2	225				M/U	M				J
4.7	475		U	M/U	M/U**	M				S
10	106		U	M/U**	M	S				a
15	156		U							e
22	226		M/U**	M	M**/S					J
33	336		M	M	M**/S					n
47	476	M	M	M/S	S					s
68	686		M/S							w
100	107		M/S	M*/S						A
220	227		S							J

RATINGS & PART NUMBER REFERENCE

AVX Part No.	Case Size	Capacitance (µF)	Rated Voltage (V)	DCL (µA)	DF @ 120Hz (%)	ESR @ 100kHz (Ω)	100kHz RMS Current (mA)				*1 ΔC/C (%)	MSL
							25°C	60°C	85°C	125°C		
2.5 Volt												
F980E476MMA	M	47	2.5	1.2	30	4	79	–	71	32	±30	3
4 Volt												
F980G475MUA	U	4.7	4	0.5	20	20	27	–	25	11	±30	3
F980G106MUA	U	10	4	0.8	25	20	27	–	25	11	±30	3
F980G156MUA	U	15	4	9.0	40	25	24	–	22	10	±30	3
F980G226MMA	M	22	4	0.9	15	7.5	58	–	52	23	±30	3
F980G226MUALZT	U	22	4	25.0	40	20	27	25	–	11	±30	3
F980G336MMA	M	33	4	1.3	30	4	79	–	71	32	±30	3
F980G476MMA	M	47	4	1.9	40	8	56	–	50	22	±30	3
F980G686MMA	M	68	4	27.2	50	10	50	–	45	20	±30	3
F980G686MSA	S	68	4	2.7	30	4	106	–	95	42	±30	3
F980G107MMA	M	100	4	80.0	60	10	50	–	45	20	±30	3
F980G107MSA	S	100	4	4.0	35	4	106	–	95	42	±30	3
F980G227MSA	S	220	4	132	80	5	95	–	85	38	±30	3
6.3 Volt												
F980J475MMA	M	4.7	6.3	0.5	20	7.5	58	–	52	23	±30	3
F980J475MUA	U	4.7	6.3	0.6	20	20	27	–	25	11	±30	3
F980J106MMA	M	10	6.3	0.6	8	6	65	–	58	26	±30	3
F980J106MUALZT	U	10	6.3	6.3	30	30	22	20	–	9	±30	3
F980J226MMA	M	22	6.3	1.4	20	6	65	–	58	26	±30	3
F980J336MMA	M	33	6.3	4.2	35	8	56	–	50	22	±30	3
F980J476MMA	M	47	6.3	29.6	45	10	50	–	45	20	±30	3
F980J476MSA	S	47	6.3	3.0	25	6	87	–	78	35	±30	3
F980J107MMAAXE	M	100	6.3	126	80	10	50	45	–	20	±30	3
F980J107MSA	S	100	6.3	63.0	50	8	75	–	68	30	±30	3
10 Volt												
F981A225MMA	M	2.2	10	0.5	6	7.5	58	–	52	23	±30	3
F981A225MUA	U	2.2	10	0.5	15	15	32	–	28	13	±30	3
F981A475MMA	M	4.7	10	0.5	6	6	65	–	58	26	±30	3
F981A475MUALZT	U	4.7	10	4.7	25	25	24	22	–	10	±30	3
F981A106MMA	M	10	10	1.0	20	7.5	58	–	52	23	±30	3
F981A226MMALZT	M	22	10	11.0	30	8	56	50	–	22	±30	3
F981A226MSA	S	22	10	2.2	20	4	106	–	95	42	±30	3
F981A336MMALZT	M	33	10	33.0	45	8	56	50	–	22	±30	3
F981A336MSA	S	33	10	3.3	30	6	87	–	78	35	±30	3
F981A476MSA	S	47	10	9.4	35	5	95	–	85	38	±30	3
16 Volt												
F981C474MUA	U	0.47	16	0.5	6	25	24	–	22	10	±20	3
F981C105MMA	M	1	16	0.5	6	10	50	–	45	20	±30	3
F981C225MMA	M	2.2	16	0.5	6	10	50	–	45	20	±30	3
F981C475MMA	M	4.7	16	0.8	12	12	46	–	41	18	±30	3
F981C106MSA	S	10	16	1.6	18	4	106	–	95	42	±30	3
20 Volt												
F981D105MMA	M	1	20	0.5	6	10	50	–	45	20	±30	3
25 Volt												
F981E105MMA	M	1	25	0.5	8	10	50	–	45	20	±30	3
35 Volt												
F981V105MSA	S	1	35	0.7	20	8	75	–	68	30	±30	3

*2: Leakage Current

After 5 minute's application of rated voltage, leakage current at 20°C.

Moisture Sensitivity Level (MSL) is defined according to J-STD-020.

QUALIFICATION TABLE

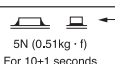
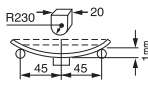
TEST	F98 series (Temperature range -55°C to +125°C)	
	Condition	
Damp Heat (Steady State)	At 40°C, 90 to 95% R.H., 500 hours (No voltage applied) Capacitance Change Refer to page 60 (*1) Dissipation Factor 150% or less of initial specified value Leakage Current 200% or less of initial specified value	
Temperature Cycles	-55°C / +125°C, 30 minutes each, 5 cycles Capacitance Change Refer to page 60 (*1) Dissipation Factor 150% or less of initial specified value Leakage Current 200% or less of initial specified value	
Resistance to Soldering Heat	10 seconds reflow at 260°C, 5 seconds immersion at 260°C. Capacitance Change Refer to page 60 (*1) Dissipation Factor Initial specified value or less Leakage Current Initial specified value or less	
Surge	After application of surge in series with a 1kΩ resistor at the rate of 30 seconds ON, 30 seconds OFF, for 1000 successive test cycles at 85°C, capacitors shall meet the characteristic requirements in the table above. Capacitance Change Refer to page 60 (*1) Dissipation Factor 150% or less of initial specified value Leakage Current 200% or less of initial specified value	
Endurance	After 1000 hours' application of rated voltage in series with a 3Ω resistor at 85°C, capacitors shall meet the characteristic requirements in the table above. Capacitance Change Refer to page 60 (*1) Dissipation Factor 150% or less of initial specified value Leakage Current 200% or less of initial specified value	
Shear Test	After applying the pressure load of 5N for 10±1 seconds horizontally to the center of capacitor side body which has no electrode and has been soldered beforehand on a substrate, there shall be found neither exfoliation nor its sign at the terminal electrode.	 5N (0.51kg · f) For 10±1 seconds
Terminal Strength	Keeping a capacitor surface-mounted on a substrate upside down and supporting the substrate at both of the opposite bottom points 45mm apart from the center of capacitor, the pressure strength is applied with a specified jig at the center of substrate so that the substrate may bend by 1mm as illustrated. Then, there shall be found no remarkable abnormality on the capacitor terminals.	 R230 20 45 45 E

AVX SOLID ELECTROLYTE CAPACITOR ROADMAP

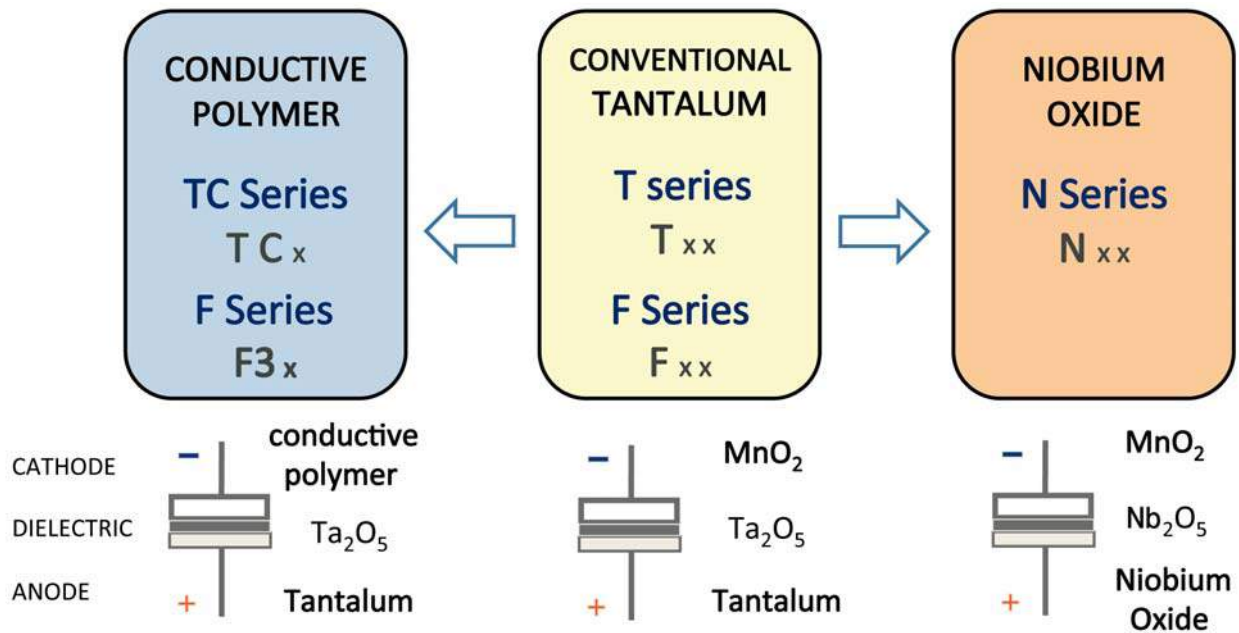

Five Capacitor Construction Styles

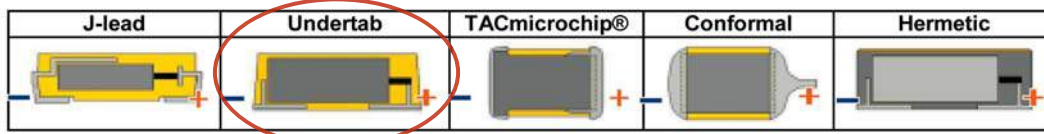

SERIES LINE UP: CONVENTIONAL SMD MnO₂

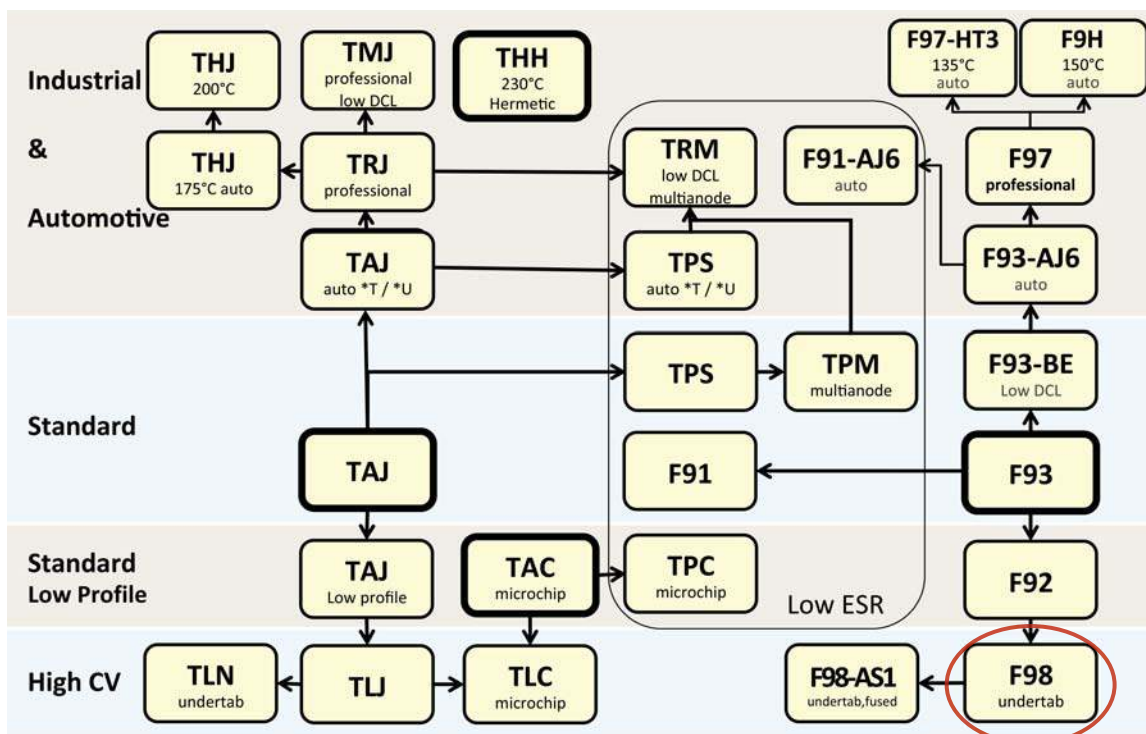

Looking for pricing, stock, or lifecycle information?

Click below to explore more details on WIN SOURCE:

 [View F981C105MMA](#) on WIN SOURCE

 [AVX Corporation](#) Information

Optimize Your Supply Chain with WIN SOURCE Solutions

-  Global Sourcing Solution
-  Obsolete Management
-  Cost Control Management
-  Shortage Management
-  Alternative Solution
-  Excess Inventory Management