

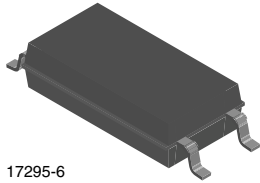

**THE DATASHEET OF  
VOL618A-3T**



# Optocoupler, Phototransistor Output, Low Input Current, 4 Pin LSOP, Long Creepage Mini-Flat Package



17295-6

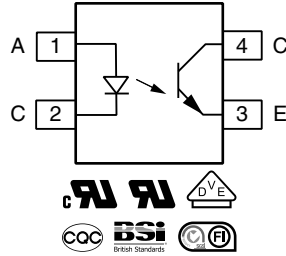

## FEATURES

- Low profile package
- High collector emitter voltage,  $V_{CE0} = 80\text{ V}$
- Isolation test voltage,  $5000\text{ V}_{RMS}$
- Isolation voltage  $V_{IORM} = 1050\text{ V}_{peak}$
- Low coupling capacitance
- High common mode transient immunity
- Material categorization: for definitions of compliance please see [www.vishay.com/doc?99912](http://www.vishay.com/doc?99912)



## DESCRIPTION

The VOL618A has a GaAs infrared emitting diode emitter, which is optically coupled to a silicon planar phototransistor detector, and is incorporated in a 4 pin LSOP wide body package.

It features a high current transfer ratio, low coupling capacitance, and high isolation voltage.

The coupling device is designed for signal transmission between two electrically separated circuits.

## APPLICATIONS

- Telecom
- Industrial controls
- Battery powered equipment
- Office machines
- Programmable controllers

## AGENCY APPROVALS

(All parts are certified under base model VOL618A)

- UL1577, file no. E76222
- cUL CSA 22.2 bulletin 5A, double protection
- DIN EN 60747-5-5 (VDE 0884-5), available with option 1
- BSI: EN 60065:2002, EN 60950-1:2006
- FIMKO EN60950-1
- CQC: GB8898-2011, GB4943.1-2011

ORDERING INFORMATION			
<div style="display: flex; justify-content: space-around;"> <div style="border: 1px solid black; padding: 2px;">V</div> <div style="border: 1px solid black; padding: 2px;">O</div> <div style="border: 1px solid black; padding: 2px;">L</div> <div style="border: 1px solid black; padding: 2px;">6</div> <div style="border: 1px solid black; padding: 2px;">1</div> <div style="border: 1px solid black; padding: 2px;">8</div> <div style="border: 1px solid black; padding: 2px;">A</div> <div style="border: 1px solid black; padding: 2px;">-</div> <div style="border: 1px solid black; padding: 2px;">#</div> <div style="border: 1px solid black; padding: 2px;">X</div> <div style="border: 1px solid black; padding: 2px;">0</div> <div style="border: 1px solid black; padding: 2px;">0</div> <div style="border: 1px solid black; padding: 2px;">1</div> <div style="border: 1px solid black; padding: 2px;">T</div> </div>	CTR BIN	PACKAGE OPTION	TAPE AND REEL
AGENCY CERTIFIED/PACKAGE	CTR (%)		
	1 mA		
UL, cUL, BSI, FIMKO, CQC	50 to 600	63 to 125	100 to 200
4 pin LSOP, mini-flat, long creepage	VOL618AT	VOL618A-2T	VOL618A-3T
UL, cUL, BSI, FIMKO, CQC, VDE (option 1)	50 to 600	63 to 125	100 to 200
4 pin LSOP, mini-flat, long creepage	-	VOL618A-2X001T	VOL618A-3X001T

<b>ABSOLUTE MAXIMUM RATINGS</b> ( $T_{amb} = 25\text{ }^{\circ}\text{C}$ , unless otherwise specified)				
PARAMETER	TEST CONDITION	SYMBOL	VALUE	UNIT
<b>INPUT</b>				
Reverse voltage		$V_R$	6	V
Power dissipation		$P_{diss}$	100	mW
Forward current		$I_F$	60	mA
Forward surge current	$t_p < 10\text{ }\mu\text{s}$	$I_{FSM}$	1.5	A
Junction temperature		$T_j$	125	$^{\circ}\text{C}$
<b>OUTPUT</b>				
Collector emitter voltage		$V_{CEO}$	80	V
Emitter collector voltage		$V_{ECO}$	7	V
Collector current		$I_C$	50	mA
	$t_p/T = 0.5, t_p < 10\text{ ms}$	$I_C$	100	mA
Power dissipation		$P_{diss}$	150	mW
Junction temperature		$T_j$	125	$^{\circ}\text{C}$
<b>COUPLER</b>				
Total power dissipation		$P_{tot}$	250	mW
Storage temperature range		$T_{stg}$	-55 to +125	$^{\circ}\text{C}$
Ambient temperature range		$T_{amb}$	-55 to +110	$^{\circ}\text{C}$
Soldering temperature <sup>(1)</sup>	$\leq 10\text{ s}$	$T_{sld}$	260	$^{\circ}\text{C}$

**Notes**

- Stresses in excess of the absolute maximum ratings can cause permanent damage to the device. Functional operation of the device is not implied at these or any other conditions in excess of those given in the operational sections of this document. Exposure to absolute maximum ratings for extended periods of the time can adversely affect reliability.

<sup>(1)</sup> Refer to reflow profile for soldering conditions for surface mounted devices.

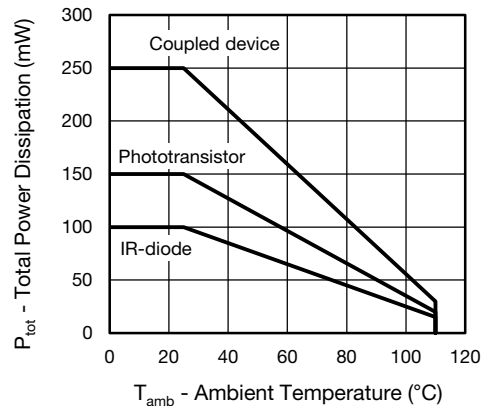

Fig. 1 - Total Power Dissipation vs. Ambient Temperature

<b>ELECTRICAL CHARACTERISTICS</b> ( $T_{amb} = 25\text{ }^{\circ}\text{C}$ , unless otherwise specified)							
PARAMETER	TEST CONDITION	PART	SYMBOL	MIN.	TYP.	MAX.	UNIT
<b>INPUT</b>							
Forward voltage	$I_F = 5\text{ mA}$		$V_F$	-	1.16	1.5	V
Capacitance	$V_R = 0\text{ V}, f = 1\text{ MHz}$		$C_O$	-	45	-	pF
Reverse current	$V_R = 6\text{ V}$		$I_R$	-	-	100	$\mu\text{A}$
<b>OUTPUT</b>							
Collector emitter leakage current	$V_{CE} = 10\text{ V}, I_F = 0\text{ A}$		$I_{CEO}$	-	10	200	nA
Collector emitter capacitance	$V_{CE} = 5\text{ V}, f = 1\text{ MHz}$		$C_{CE}$	-	7	-	pF
<b>COUPLER</b>							
Collector emitter saturation voltage	$I_C = 0.32\text{ mA}, I_F = 1\text{ mA}$	VOL618A-2	$V_{CEsat}$	-	0.25	0.4	V
	$I_C = 0.5\text{ mA}, I_F = 1\text{ mA}$	VOL618A-3	$V_{CEsat}$	-	0.25	0.4	V
	$I_C = 0.8\text{ mA}, I_F = 1\text{ mA}$	VOL618A-4	$V_{CEsat}$	-	0.25	0.4	V
Coupling capacitance	$f = 1\text{ MHz}$		$C_C$	-	0.25	-	pF

**Note**

- Minimum and maximum values are testing requirements. Typical values are characteristics of the device and are the result of engineering evaluation. Typical values are for information only and are not part of the testing requirements.

<b>CURRENT TRANSFER RATIO</b> ( $T_{amb} = 25\text{ }^{\circ}\text{C}$ , unless otherwise specified)							
PARAMETER	TEST CONDITION	PART	SYMBOL	MIN.	TYP.	MAX.	UNIT
$I_C/I_F$	$I_F = 1\text{ mA}$ , $V_{CE} = 5\text{ V}$	VOL618A	CTR	50	-	600	%
		VOL618A-2	CTR	63	-	125	%
		VOL618A-3	CTR	100	-	200	%

<b>SWITCHING CHARACTERISTICS</b> ( $T_{amb} = 25\text{ }^{\circ}\text{C}$ , unless otherwise specified)							
PARAMETER	TEST CONDITION	SYMBOL	MIN.	TYP.	MAX.	UNIT	
Turn on time	$V_{CC} = 5\text{ V}$ , $I_C = 2\text{ mA}$ , $R_L = 100\text{ }\Omega$	$t_{on}$	-	6	-	$\mu\text{s}$	
Rise time	$V_{CC} = 5\text{ V}$ , $I_C = 2\text{ mA}$ , $R_L = 100\text{ }\Omega$	$t_r$	-	3.5	-	$\mu\text{s}$	
Turn off time	$V_{CC} = 5\text{ V}$ , $I_C = 2\text{ mA}$ , $R_L = 100\text{ }\Omega$	$t_{off}$	-	5.5	-	$\mu\text{s}$	
Fall time	$V_{CC} = 5\text{ V}$ , $I_C = 2\text{ mA}$ , $R_L = 100\text{ }\Omega$	$t_f$	-	5	-	$\mu\text{s}$	

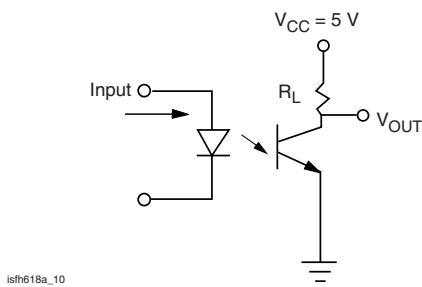

Fig. 2 - Test Circuit

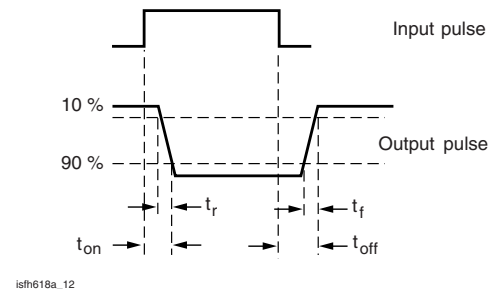

Fig. 3 - Test Circuit and Waveforms

<b>SAFETY AND INSULATION RATINGS</b>					
PARAMETER	TEST CONDITION	SYMBOL	VALUE	UNIT	
Partial discharge test voltage - routine test	100 %, $t_{test} = 1\text{ s}$	$V_{pd}$	2	$\text{kV}_{peak}$	
Partial discharge test voltage - lot test (sample test)	$t_{Tr} = 60\text{ s}$ , $t_{test} = 10\text{ s}$ , (see figure 4)	$V_{IOTM}$	8	$\text{kV}_{peak}$	
		$V_{pd}$	1.68	$\text{kV}_{peak}$	
Isolation test voltage between emitter and detector	$t = 1\text{ min}$	$V_{ISO}$	5000	$\text{V}_{RMS}$	
Insulation voltage		$V_{IORM}$	1050	$\text{V}_{peak}$	
Insulation resistance	$V_{IO} = 500\text{ V}_{DC}$ , $T_{amb} = 25\text{ }^{\circ}\text{C}$	$R_{IO}$	$10^{12}$	$\Omega$	
	$V_{IO} = 500\text{ V}_{DC}$ , $T_{amb} = 100\text{ }^{\circ}\text{C}$	$R_{IO}$	$10^{11}$	$\Omega$	
	$V_{IO} = 500\text{ V}_{DC}$ , $T_{amb} = 150\text{ }^{\circ}\text{C}$ (construction test only)	$R_{IO}$	$10^9$	$\Omega$	
Safety rating - maximum input current		$I_{si}$	130	mA	
Safety rating - maximum power dissipation		$P_{SO}$	265	mW	
Rated impulse voltage		$V_{IOTM}$	8	kV	
Safety rating - maximum ambient temperature		$T_{si}$	150	$^{\circ}\text{C}$	
Comparative tracking index		CTI	275	mm	
Clearance distance			8	mm	
Creepage distance			8	mm	
Insulation distance (internal)			0.4	mm	

**Note**

- According to DIN EN 60747-5-5 (VDE 0884), § 7.4.3.8.2, (see figure 4). This optocoupler is suitable for safe electrical isolation only within the safety ratings. Compliance with the safety ratings shall be ensured by means of suitable protective circuits.

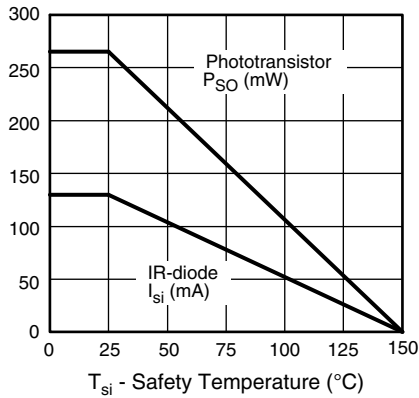

Fig. 4 - Derating Diagram

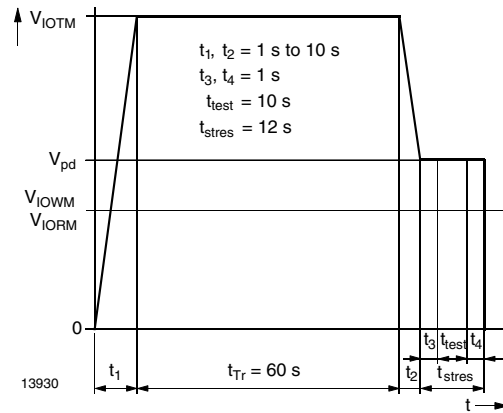

Fig. 5 - Test Pulse Diagram for Sample Test according to DIN EN 60747-5-5

**TYPICAL CHARACTERISTICS** ( $T_{amb} = 25\text{ }^\circ\text{C}$ , unless otherwise specified)

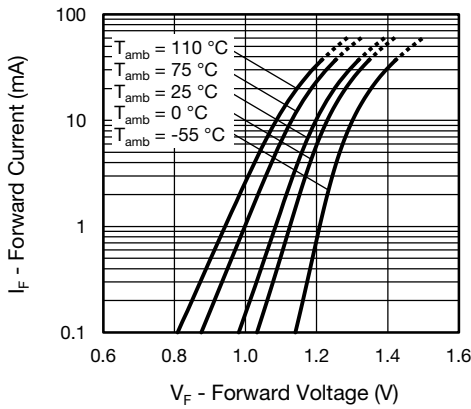

Fig. 6 - Forward Voltage vs. Forward Current

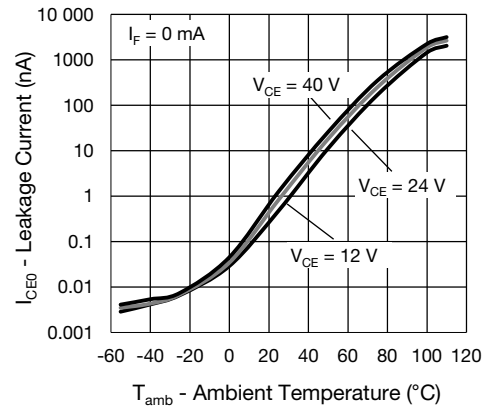

Fig. 8 - Collector Emitter Current vs. Ambient Temperature

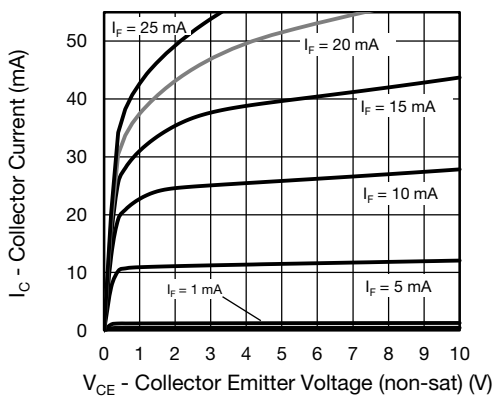

Fig. 7 - Collector Current vs. Collector Emitter Voltage (non-saturated)

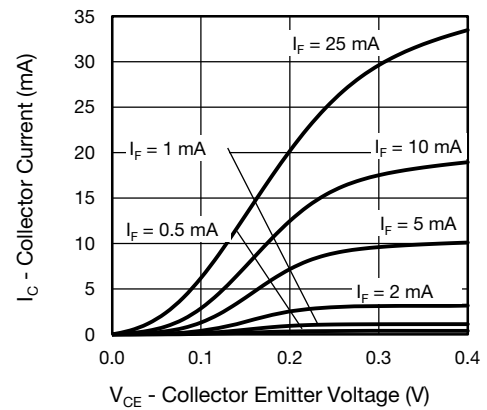

Fig. 9 - Collector Current vs. Collector Emitter Voltage (saturated)

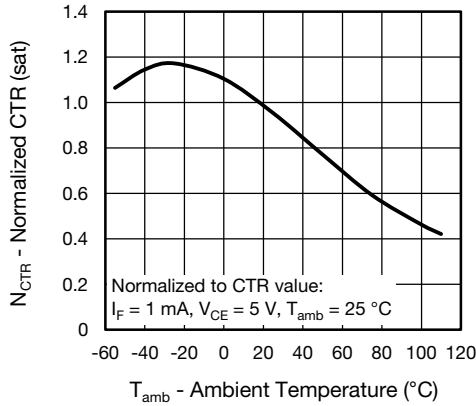

Fig. 10 - Normalized Current Transfer Ratio vs. Ambient Temperature (saturated)

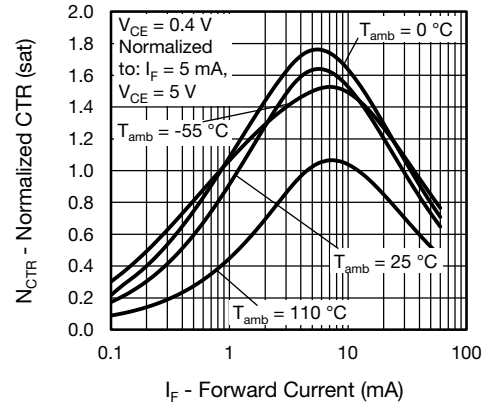

Fig. 13 - Current Transfer Ratio vs. Forward Current (non-saturated) Normalized to 1 mA at 25 °C

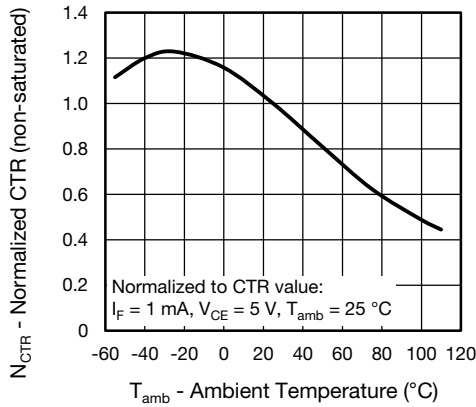

Fig. 11 - Normalized Current Transfer Ratio vs. Ambient Temperature (non-saturated)

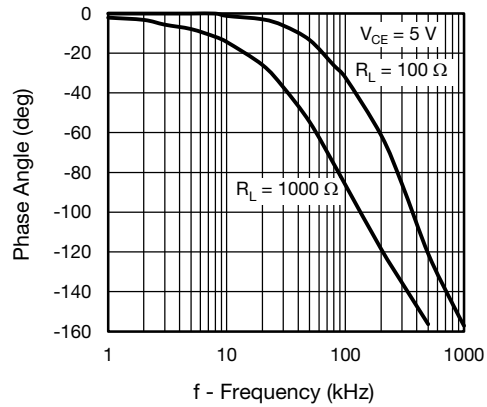

Fig. 14 -  $f_{CTR}$  vs. Phase Angle

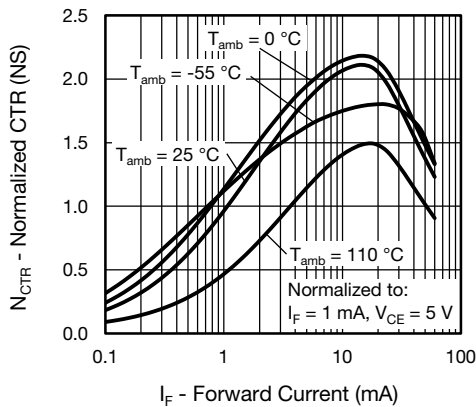

Fig. 12 - Current Transfer Ratio vs. Forward Current (saturated) Normalized to 1 mA at 25 °C

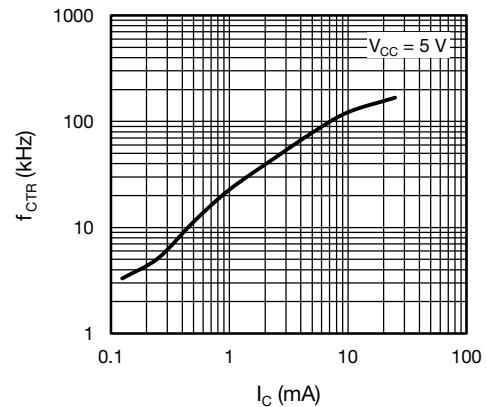

Fig. 15 - Frequency (-3 dB) vs. Collector Current

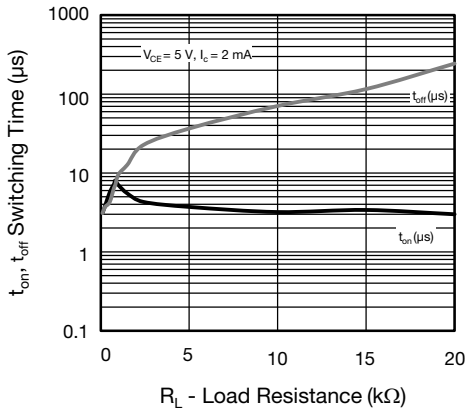

Fig. 16 - Switching Time vs. Load Resistance

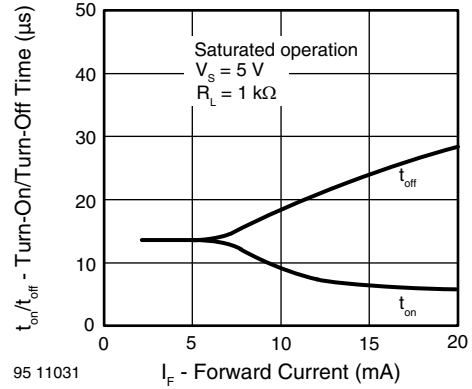

Fig. 18 - Turn-On/Turn-Off Time vs. Forward Current

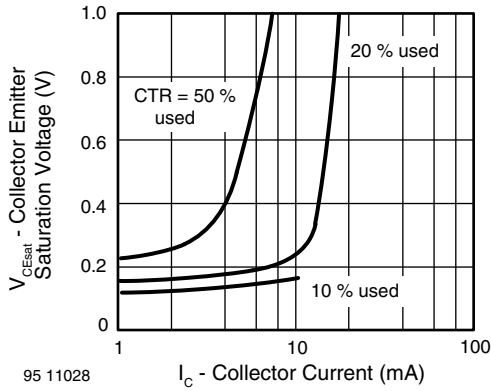

Fig. 17 - Collector Emitter Saturation Voltage vs. Collector Current

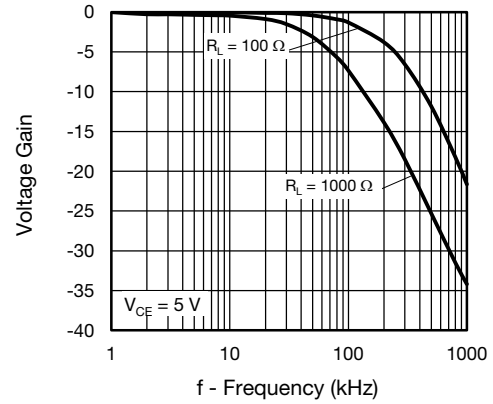
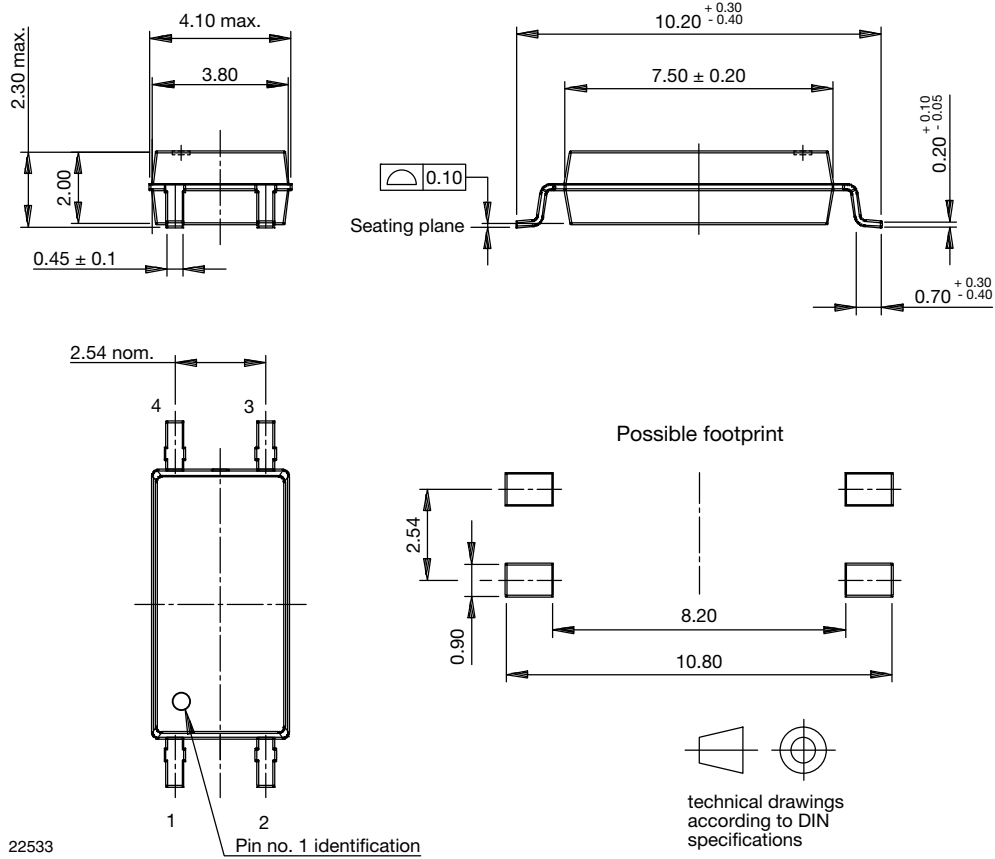
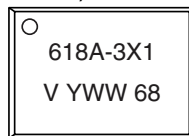

Fig. 19 - Voltage Gain vs. Cut-off Frequency

**PACKAGE DIMENSIONS** (in millimeters)



**PACKAGE MARKING** (example of VOL618A-3X001T)



**Notes**

- Only option 1 is reflected in the package marking with the characters "X1".
- Tape and reel suffix (T) is not part of the package marking.

**TAPE AND REEL DIMENSIONS** (in millimeters)

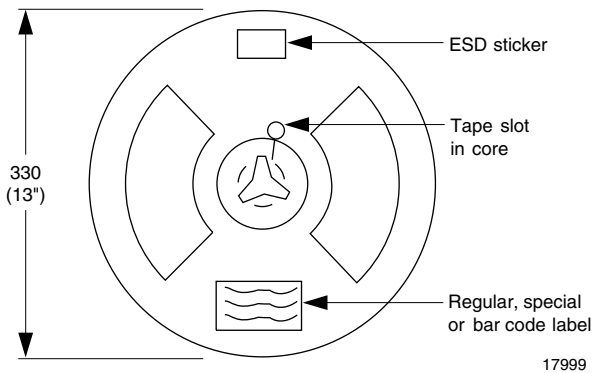

Fig. 20 - Reel Dimensions (3000 units per reel)

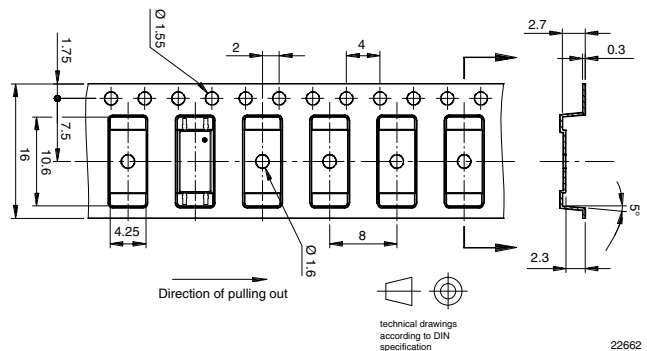
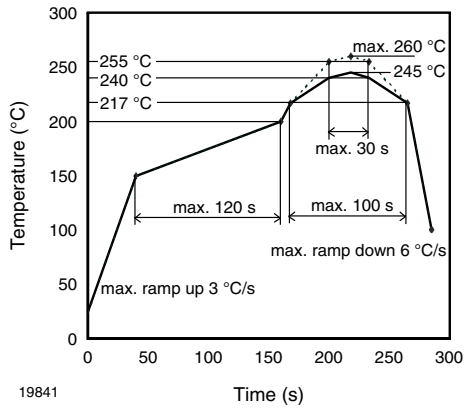

Fig. 21 - Tape Dimensions

**SOLDER PROFILE**



19841

Fig. 22 - Lead (Pb)-free Reflow Solder Profile according to J-STD-020

**HANDLING AND STORAGE CONDITIONS**

ESD level: HBM class 2

Floor life: unlimited

Conditions:  $T_{amb} < 30\text{ °C}$ , RH < 85 %

Moisture sensitivity level 1, according to J-STD-020



## **Disclaimer**

ALL PRODUCT, PRODUCT SPECIFICATIONS AND DATA ARE SUBJECT TO CHANGE WITHOUT NOTICE TO IMPROVE RELIABILITY, FUNCTION OR DESIGN OR OTHERWISE.

Vishay Intertechnology, Inc., its affiliates, agents, and employees, and all persons acting on its or their behalf (collectively, "Vishay"), disclaim any and all liability for any errors, inaccuracies or incompleteness contained in any datasheet or in any other disclosure relating to any product.

Vishay makes no warranty, representation or guarantee regarding the suitability of the products for any particular purpose or the continuing production of any product. To the maximum extent permitted by applicable law, Vishay disclaims (i) any and all liability arising out of the application or use of any product, (ii) any and all liability, including without limitation special, consequential or incidental damages, and (iii) any and all implied warranties, including warranties of fitness for particular purpose, non-infringement and merchantability.

Statements regarding the suitability of products for certain types of applications are based on Vishay's knowledge of typical requirements that are often placed on Vishay products in generic applications. Such statements are not binding statements about the suitability of products for a particular application. It is the customer's responsibility to validate that a particular product with the properties described in the product specification is suitable for use in a particular application. Parameters provided in datasheets and / or specifications may vary in different applications and performance may vary over time. All operating parameters, including typical parameters, must be validated for each customer application by the customer's technical experts. Product specifications do not expand or otherwise modify Vishay's terms and conditions of purchase, including but not limited to the warranty expressed therein.

Except as expressly indicated in writing, Vishay products are not designed for use in medical, life-saving, or life-sustaining applications or for any other application in which the failure of the Vishay product could result in personal injury or death. Customers using or selling Vishay products not expressly indicated for use in such applications do so at their own risk. Please contact authorized Vishay personnel to obtain written terms and conditions regarding products designed for such applications.

No license, express or implied, by estoppel or otherwise, to any intellectual property rights is granted by this document or by any conduct of Vishay. Product names and markings noted herein may be trademarks of their respective owners.

## Looking for pricing, stock, or lifecycle information?

Click below to explore more details on WIN SOURCE:

 [View VOL618A-3T on WIN SOURCE](#)

 [Vishay Information](#)

## Optimize Your Supply Chain with WIN SOURCE Solutions

-  Global Sourcing Solution
-  Obsolete Management
-  Cost Control Management
-  Shortage Management
-  Alternative Solution
-  Excess Inventory Management