



**THE DATASHEET OF
ADM6384YKS23D3-RL7**



FEATURES

- Precision power supply monitoring
- 31 reset threshold options: 1.58 V to 5.0 V
- Four reset timeouts: 1 ms, 20 ms, 140 ms, and 1120 ms
- Manual reset input
- Reset output stage
- Push pull active low
- Guaranteed reset output valid to $V_{CC} = 1$ V
- Power supply glitch immunity
- Specified over the -40°C to $+125^{\circ}\text{C}$ temperature range
- 4-lead SC70 package

APPLICATIONS

- Microprocessor systems
- Computers
- Controllers
- Intelligent instruments
- Portable equipment

GENERAL DESCRIPTION

The [ADM6384](#) is a supervisory circuit that monitors power supply voltage levels in microprocessor-based systems. A power-on reset signal is generated when the supply voltage rises to a preset threshold level. The debounced manual reset input of the [ADM6384](#) can be used to initiate a reset by means of an external push button or logic signal.

FUNCTIONAL BLOCK DIAGRAMS

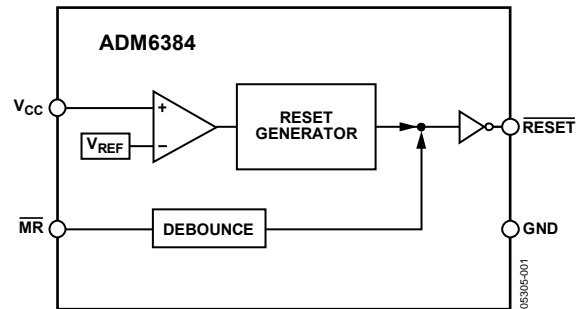

Figure 1.

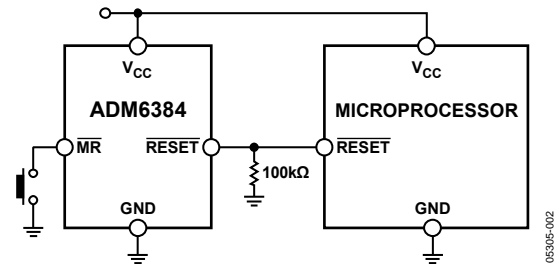

Figure 2.

The device is available in a choice of 31 reset threshold options, from 1.58 V to 5.0 V. The minimum reset timeout periods are 1 ms, 20 ms, 140 ms, and 1120 ms. Not all device options are released for sale as standard models. See Ordering Guide for details.

The [ADM6384](#) is available in a 4-lead SC70 package and typically consumes only 7 μA , making it suitable for use in low power, portable applications.

TABLE OF CONTENTS

Features	1	Typical Performance Characteristics	7
Applications	1	Circuit Description	9
Functional Block Diagrams	1	Reset Output	9
General Description	1	Manual Reset Input	9
Revision History	2	Applications Information	10
Specifications	3	Negative Going V_{CC} Transients	10
Absolute Maximum Ratings	5	Ensuring Reset Valid to $V_{CC} = 0 V$	10
ESD Caution	5	Outline Dimensions	11
Pin Configuration and Function Descriptions	6	Ordering Guide	11

REVISION HISTORY

4/2018—Rev. D to Rev. E

Changes to General Description Section	1
Added Note 2, Table 1; Renumbered Sequentially	3
Changes to Ordering Guide	11

6/2016—Rev. C to Rev. D

Change to Table 3	6
Updated Outline Dimensions	11

4/2011—Rev. B to Rev. C

Updated Outline Dimensions	11
Changes to Ordering Guide	11

7/2008—Rev. A to Rev. B

Changes to Figure 5, Figure 8, and Figure 9	7
Changes to Figure 10	8
Changes to Figure 15	11
Changes to Ordering Guide	11

1/2007—Rev. 0 to Rev. A

Updated Format	Universal
Changes to Specifications Table	3
Updated Outline Dimensions	11
Changes to Ordering Guide	11

7/2005—Revision 0: Initial Version

SPECIFICATIONS

V_{CC} = full operating range, T_A = -40°C to $+125^{\circ}\text{C}$, unless otherwise noted.

Table 1.

Parameter	Min	Typ	Max	Unit	Test Conditions/Comments
SUPPLY					
V_{CC} Operating Voltage Range	1		5.5	V	
Supply Current		7	13	μA	$V_{CC} = 5.5\text{ V}$, no load
		6	11	μA	$V_{CC} = 3.6\text{ V}$, no load
		4	7	μA	$V_{CC} = 2.5\text{ V}$, no load ¹
		3	6	μA	$V_{CC} = 1.8\text{ V}$, no load ¹
RESET THRESHOLD VOLTAGE ²					
ADM6384x50x	4.88	5.00	5.12	V	
ADM6384x49x	4.78	4.90	5.02	V	
ADM6384x48x	4.68	4.80	4.92	V	
ADM6384x47x	4.58	4.70	4.82	V	
ADM6384x46x	4.51	4.63	4.74	V	
ADM6384x45x	4.39	4.5	4.61	V	
ADM6384x44x	4.27	4.38	4.48	V	
ADM6384x43x	4.19	4.30	4.41	V	
ADM6384x42x	4.1	4.2	4.31	V	
ADM6384x41x	4.0	4.1	4.2	V	
ADM6384x40x	3.9	4.0	4.1	V	
ADM6384x39x	3.8	3.9	4.0	V	
ADM6384x38x	3.71	3.8	3.9	V	
ADM6384x37x	3.61	3.7	3.79	V	
ADM6384x36x	3.51	3.6	3.69	V	
ADM6384x35x	3.41	3.5	3.59	V	
ADM6384x34x	3.32	3.4	3.49	V	
ADM6384x33x	3.22	3.3	3.38	V	
ADM6384x32x	3.12	3.2	3.28	V	
ADM6384x31x	3.00	3.08	3.15	V	
ADM6384x30x	2.93	3.0	3.08	V	
ADM6384x29x	2.85	2.93	3.00	V	
ADM6384x28x	2.73	2.8	2.87	V	
ADM6384x27x	2.63	2.70	2.77	V	
ADM6384x26x	2.56	2.63	2.69	V	
ADM6384x25x	2.44	2.5	2.56	V	
ADM6384x24x	2.34	2.4	2.46	V	
ADM6384x23x	2.26	2.31	2.37	V	
ADM6384x22x	2.13	2.19	2.24	V	
ADM6384x17x	1.62	1.67	1.71	V	
ADM6384x16x	1.54	1.58	1.61	V	
RESET THRESHOLD TEMPERATURE COEFFICIENT					
V_{CC} to Reset Delay		60		ppm/ $^{\circ}\text{C}$	
		35		μs	V_{CC} falling at $10\text{ mV}/\mu\text{s}$ from $V_{TH} + 100\text{ mV}$ to $V_{TH} - 100\text{ mV}$
RESET THRESHOLD HYSTERESIS					
		$2 \times V_{TH}$		mV	
RESET TIMEOUT PERIOD ²					
ADM6384xxD1	1		2	ms	
ADM6384xxD2	20		40	ms	
ADM6384xxD3	140		280	ms	
ADM6384xxD4	1120		2240	ms	

Parameter	Min	Typ	Max	Unit	Test Conditions/Comments
MANUAL RESET INPUT					
$\overline{\text{MR}}$ Input Threshold					
V_{IL}			$0.3 \times V_{\text{CC}}$	V	$V_{\text{CC}} < 4\text{ V}$
			0.8	V	$V_{\text{CC}} > 4\text{ V}$
V_{IH}	$0.7 \times V_{\text{CC}}$			V	$V_{\text{CC}} < 4\text{ V}$
	2.4			V	$V_{\text{CC}} > 4\text{ V}$
$\overline{\text{MR}}$ Input Pulse Width	1			μs	
$\overline{\text{MR}}$ Glitch Rejection		100		ns	
$\overline{\text{MR}}$ Pull-Up Resistance	32	63	100	kV	
$\overline{\text{MR}}$ to Reset Delay		200		ns	
RESET OUTPUT VOLTAGE					
V_{OL}			0.3	V	$V_{\text{CC}} \geq 1.0\text{ V}, I_{\text{SINK}} = 80\ \mu\text{A}$
			0.3	V	$V_{\text{CC}} \geq 2.5\text{ V}, I_{\text{SINK}} = 1.2\text{ mA}$
			0.4	V	$V_{\text{CC}} \geq 4.5\text{ V}, I_{\text{SINK}} = 3.2\text{ mA}$
V_{OH}	$0.8 \times V_{\text{CC}}$			V	$V_{\text{CC}} \geq 2.5\text{ V}, I_{\text{SOURCE}} = 500\ \mu\text{A}$
	$0.8 \times V_{\text{CC}}$			V	$V_{\text{CC}} \geq 4.5\text{ V}, I_{\text{SOURCE}} = 800\ \mu\text{A}$

¹ $T_{\text{A}} = 25^{\circ}\text{C}$ only.

² Not all devices are released for sale as standard models. See the Ordering Guide for details.

ABSOLUTE MAXIMUM RATINGS

$T_A = 25^\circ\text{C}$, unless otherwise noted.

Table 2.

Parameter	Rating
V_{CC}	-0.3 V to +6 V
$\overline{\text{RESET}}$	-0.3 V to +6 V
Output Current ($\overline{\text{RESET}}$)	20 mA
Operating Temperature Range	-40°C to +125°C
Storage Temperature Range	-65°C to +150°C
θ_{JA} Thermal Impedance, SC70	331°C/W
Soldering Temperature	
Sn/Pb	240°C, 30 sec
Pb-Free	260°C, 40 sec

Stresses at or above those listed under Absolute Maximum Ratings may cause permanent damage to the product. This is a stress rating only; functional operation of the product at these or any other conditions above those indicated in the operational section of this specification is not implied. Operation beyond the maximum operating conditions for extended periods may affect product reliability.

ESD CAUTION



ESD (electrostatic discharge) sensitive device. Charged devices and circuit boards can discharge without detection. Although this product features patented or proprietary protection circuitry, damage may occur on devices subjected to high energy ESD. Therefore, proper ESD precautions should be taken to avoid performance degradation or loss of functionality.

PIN CONFIGURATION AND FUNCTION DESCRIPTIONS

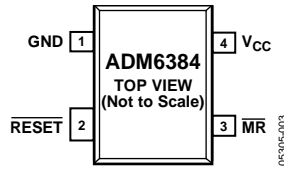

Figure 3. Pin Configuration

Table 3. Pin Function Descriptions

Pin No.	Mnemonic	Description
1	GND	Ground.
2	$\overline{\text{RESET}}$	Active Low Reset Output. This is an active low output that is asserted whenever V_{CC} is below the reset threshold (V_{TH}). It features a push pull output stage.
3	$\overline{\text{MR}}$	Manual Reset Input. This is an active low input that, when forced low for at least 1 μs , generates a reset. It features a 52 k Ω internal pull-up.
4	V_{CC}	Power Supply Voltage Being Monitored.

TYPICAL PERFORMANCE CHARACTERISTICS

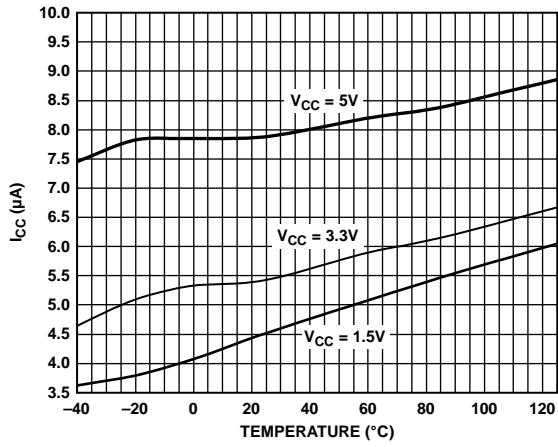

Figure 4. Supply Current vs. Temperature

05305-004

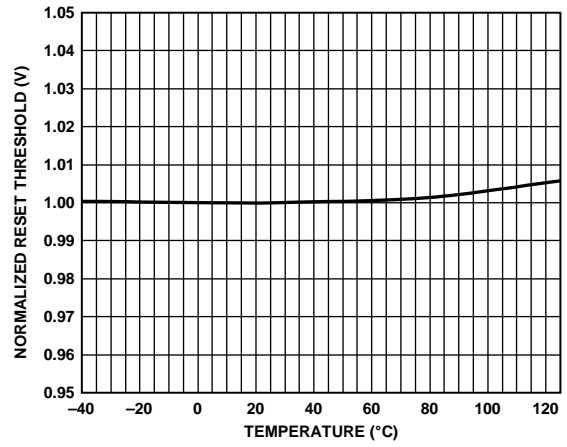

Figure 7. Normalized Reset Threshold vs. Temperature

05305-007

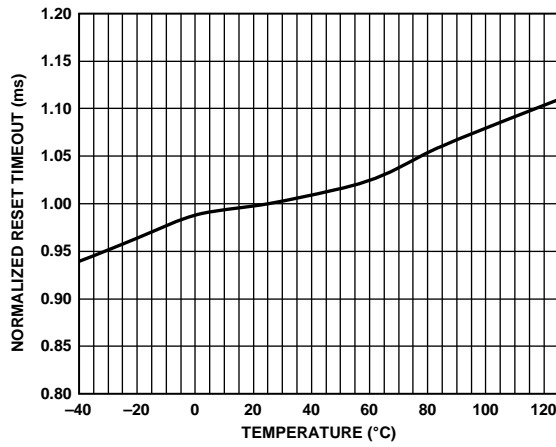

Figure 5. Normalized Reset Timeout Period vs. Temperature

05305-005

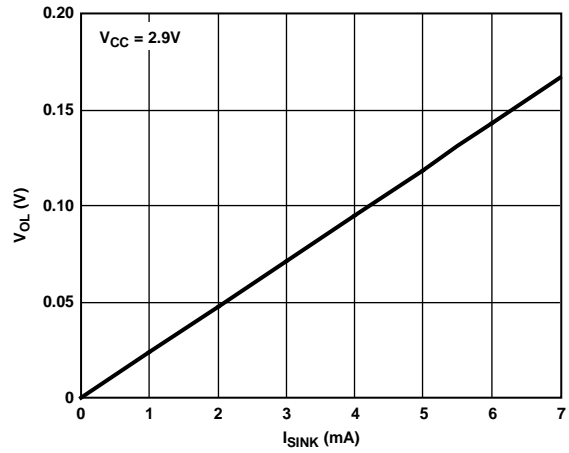

Figure 8. Output Voltage Low vs. I_{SINK}

05305-008

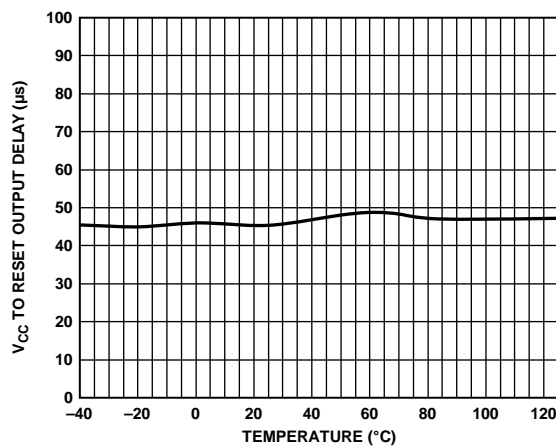

Figure 6. V_{CC} to Reset Output Delay vs. Temperature

05305-006

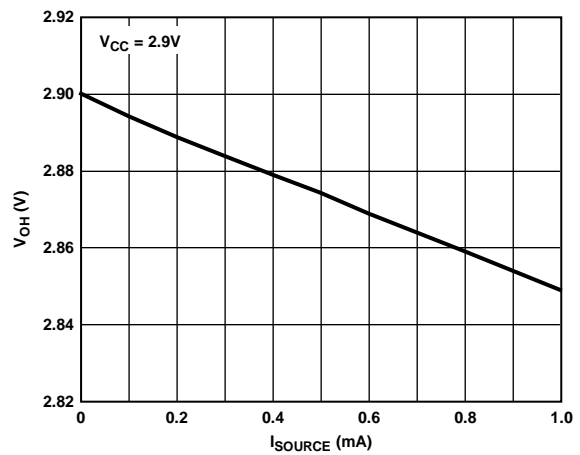

Figure 9. Output Voltage High vs. I_{SOURCE}

05305-009

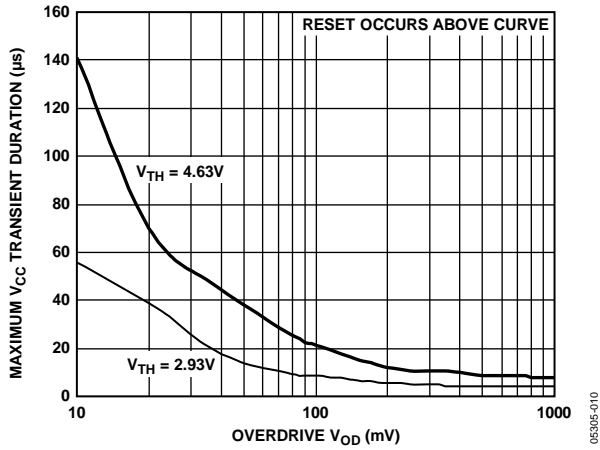

Figure 10. Maximum V_{CC} Transient Duration vs. Reset Threshold Overdrive

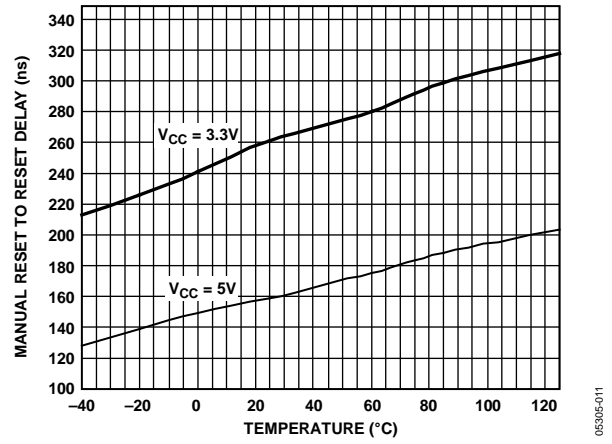

Figure 11. Manual Reset Minimum Pulse Width vs. Temperature

CIRCUIT DESCRIPTION

The [ADM6384](#) provides microprocessor supply voltage supervision by controlling the microprocessor reset input. Code execution errors are avoided during power-up, power-down, and brownout conditions by asserting a reset signal when the supply voltage is below a preset threshold. In addition, the [ADM6384](#) allows supply voltage stabilization with a fixed timeout before the reset deasserts after the supply voltage rises above the threshold. If the user detects a problem with the system operation, a manual reset input is available to reset the microprocessor by means of an external push-button, for example.

RESET OUTPUT

The [ADM6384](#) features an active low, push pull reset output. The reset signal is guaranteed to be logic low for V_{CC} down to 1 V.

The reset output is asserted when V_{CC} is below the reset threshold (V_{TH}) or when \overline{MR} is driven low. Reset remains asserted for the duration of the reset active timeout period (t_{RP}) after V_{CC} rises above the reset threshold or after \overline{MR} transitions from low to high. Figure 12 illustrates the behavior of the reset outputs.

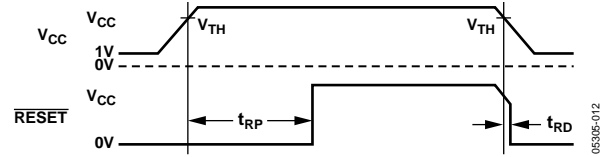

Figure 12. Reset Timing Diagram

MANUAL RESET INPUT

The [ADM6384](#) features a manual reset input (\overline{MR}) that, when driven low, asserts the reset output. When \overline{MR} transitions from low to high, reset remains asserted for the duration of the reset active timeout period before deasserting. The \overline{MR} input has a 52 k Ω internal pull-up so that the input is always high when unconnected. An external push-button switch can be connected between \overline{MR} and ground so that the user can generate a reset. Debounce circuitry for this purpose is integrated on-chip. Noise immunity is provided on the \overline{MR} input, and fast, negative going transients of up to 100 ns (typical) are ignored. A 0.1 μ F capacitor between \overline{MR} and ground provides additional noise immunity.

APPLICATIONS INFORMATION

NEGATIVE GOING V_{CC} TRANSIENTS

To avoid unnecessary resets caused by fast power supply transients, the ADM6384 is equipped with glitch rejection circuitry. The typical performance characteristic shown in Figure 10 plots V_{CC} transient duration vs. the transient magnitude. The curves show combinations of transient magnitude and duration for which a reset is not generated for 4.63 V and 2.93 V reset threshold devices. For example, with the 2.93 V threshold, a transient that goes 100 mV below the threshold and lasts 8 μ s typically does not cause a reset, but if the transient is any greater in magnitude or duration, a reset is generated. An optional 0.1 μ F bypass capacitor mounted close to V_{CC} provides additional glitch rejection.

ENSURING RESET VALID TO $V_{CC} = 0$ V

Both active low and active-high reset outputs are guaranteed to be valid for V_{CC} as low as 1 V. However, by using an external resistor with push pull configured reset outputs, valid outputs for V_{CC} as low as 0 V are possible. For an active low reset output, a resistor connected between $\overline{\text{RESET}}$ and ground pulls the output low when it is unable to sink current. Use a large resistance such as 100 k Ω to avoid overloading the reset output when V_{CC} is above 1 V.

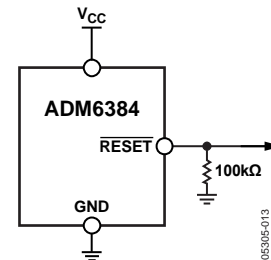
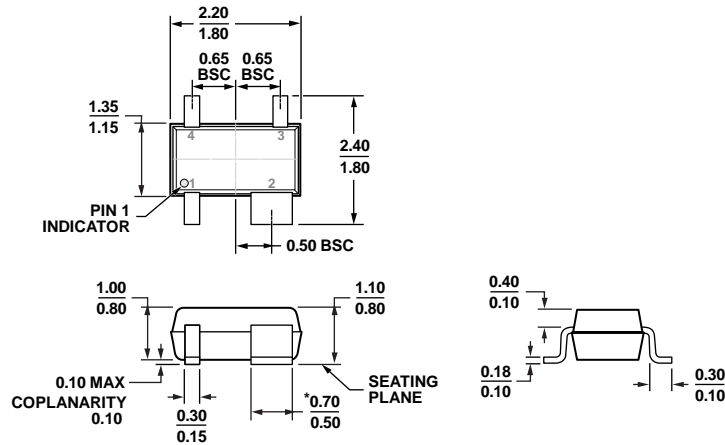

Figure 13. Ensuring Reset Valid to $V_{CC} = 0$ V

OUTLINE DIMENSIONS



*PACKAGE OUTLINE CORRESPONDS IN FULL TO EIAJ SC82 EXCEPT FOR WIDTH OF PIN 2 AS SHOWN.

Figure 14. 4-Lead Thin Shrink Small Outline Transistor Package [SC70] (KS-4)

Dimensions shown in millimeters

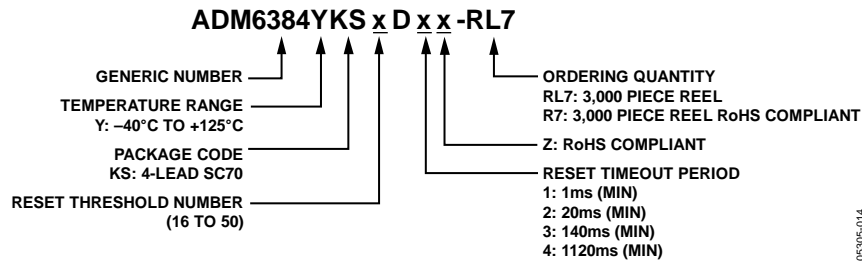

Figure 15. Ordering Code Structure

ORDERING GUIDE

Standard Models ^{1, 2, 3}	Reset Threshold (V)	Reset Timeout (ms)	Temperature Range	Package Description	Package Option	Ordering Quantity	Marking Code
ADM6384YKS17D3Z-R7	1.67	140	-40°C to +125°C	4-Lead SC70	KS-4	3,000	N0R
ADM6384YKS23D3Z-R7	2.31	140	-40°C to +125°C	4-Lead SC70	KS-4	3,000	N0R
ADM6384YKS29D1Z-R7	2.93	1	-40°C to +125°C	4-Lead SC70	KS-4	3,000	N0R
ADM6384YKS29D3Z-R7	2.93	140	-40°C to +125°C	4-Lead SC70	KS-4	3,000	N0R
ADM6384YKS31D1Z-R7	3.08	1	-40°C to +125°C	4-Lead SC70	KS-4	3,000	N0R
ADM6384YKS31D2Z-R7	3.08	20	-40°C to +125°C	4-Lead SC70	KS-4	3,000	N0R
ADM6384YKS39D2Z-R7	3.9	20	-40°C to +125°C	4-Lead SC70	KS-4	3,000	N0R
ADM6384YKS46D2Z-R7	4.63	20	-40°C to +125°C	4-Lead SC70	KS-4	3,000	N0R

¹ Z = RoHS Compliant Part.

² The ADM6384 includes many device options; however, not all options are released for sale. Released options are called standard models and are listed in the Ordering Guide. For the most up to date list of standard models, check the Simple Reset Supervisory IC page on the Analog Devices website. Contact sales for information on non-standard models and be aware that samples and production units have very long lead times.

³ If ordering nonstandard models, complete the ordering code shown in Figure 15 by inserting reset timeout and reset threshold suffixes.

NOTES

Looking for pricing, stock, or lifecycle information?

Click below to explore more details on WIN SOURCE:

- ⊖ [View ADM6384YKS23D3-RL7 on WIN SOURCE](#)
- ⊖ [Analog Devices Inc. Information](#)

Optimize Your Supply Chain with WIN SOURCE Solutions

- ✓ Global Sourcing Solution
- ✓ Obsolete Management
- ✓ Cost Control Management
- ✓ Shortage Management
- ✓ Alternative Solution
- ✓ Excess Inventory Management