

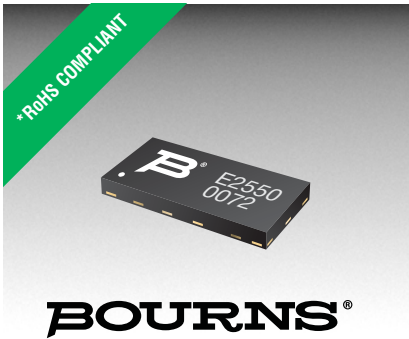



**THE DATASHEET OF  
TBU-KE050-500-WH**





## Features

- Superior circuit protection
- Overcurrent and overvoltage protection
- Blocks surges up to rated limits
- High speed performance
- Small SMT package
- RoHS compliant\*
- Agency recognition: 

## Applications

- Set top box LNB ports
- Protection modules and dongles
- Process control equipment
- Test and measurement equipment
- General electronics

# TBU-KE Series - TBU® High Speed Protectors

### General Information

The TBU-KE Series of Bourns® TBU® (Transient Blocking Unit) products are very low capacitance unidirectional high speed surge protection components designed to protect against faults caused by short circuits, AC power cross, induction and lightning surges.

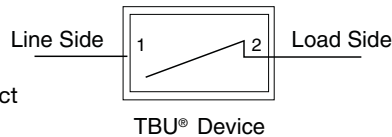

The TBU-KE is a unidirectional TBU® device: the TBU® protector will trip in less than 1  $\mu$ s when the current reaches the maximum value in one direction only, that is when Pin 1 is positive in voltage with respect to Pin 2. No current limiting exists in the opposite polarity, and the TBU® protector appears as resistive in nature. The reverse current should not exceed the maximum trip current level of the TBU® device. An external diode may be used to prevent reverse current in DC biased applications.

The TBU® protector blocks surges and provides an effective barrier behind which sensitive electronics will not be exposed to large voltages or currents during surge events. After the surge, the TBU® device resets when the voltage across the TBU® device falls to the  $V_{reset}$  level. The TBU® device will automatically reset on lines which have no DC bias or have DC bias below  $V_{reset}$  (such as unpowered signal lines).

The TBU® device is provided in a surface mount DFN package and meets industry standard requirements such as RoHS and Pb Free solder reflow profiles.

### Agency Approval

| Description |                      |
|-------------|----------------------|
| UL          | File Number: E315805 |

### Absolute Maximum Ratings (@ $T_A = 25^\circ\text{C}$ Unless Otherwise Noted)

| Symbol    | Parameter  | Part Number      | Value       | Unit             |
|-----------|--|------------------|-------------|------------------|
| $V_{imp}$ | Peak impulse voltage withstand with duration less than 10 ms | TBU-KE025-xxx-WH | 250         | V                |
|           |  | TBU-KE040-xxx-WH | 400         |                  |
|           |  | TBU-KE050-xxx-WH | 500         |                  |
| $V_{rms}$ | Continuous A.C. RMS voltage                                  | TBU-KE025-xxx-WH | 100         | V                |
|           |  | TBU-KE040-xxx-WH | 200         |                  |
|           |  | TBU-KE050-xxx-WH | 250         |                  |
| $T_{op}$  | Operating temperature range                                  |                  | -40 to +85  | $^\circ\text{C}$ |
| $T_{stg}$ | Storage temperature range                                    |                  | -65 to +150 | $^\circ\text{C}$ |

## BOURNS®

Asia-Pacific: Tel: +886-2 2562-4117 • Fax: +886-2 2562-4116

Europe: Tel: +41-41 768 5555 • Fax: +41-41 768 5510

The Americas: Tel: +1-951 781-5500 • Fax: +1-951 781-5700

[www.bourns.com](http://www.bourns.com)

\*RoHS Directive 2002/95/EC Jan 27, 2003 including Annex.

Specifications are subject to change without notice.

Customers should verify actual device performance in their specific applications.

# TBU-KE Series - TBU® High Speed Protectors

# BOURNS®

## Electrical Characteristics (@ T<sub>A</sub> = 25 °C Unless Otherwise Noted)

| Symbol               | Parameter   | Part Number   | Min.  | Typ. | Max. | Unit |   |      |    |
|----------------------|---|---|---|------|------|------|---|------|----|
| I <sub>trigger</sub> | Current required for the device to go from operating state to protected state | TBU-KExxx-050-WH  | 50  | 75   | 100  | mA   |   |      |    |
|                      |   | TBU-KExxx-100-WH  | 100   | 150  | 200  |      |   |      |    |
|                      |   | TBU-KExxx-200-WH  | 200   | 300  | 400  |      |   |      |    |
|                      |   | TBU-KExxx-300-WH  | 300   | 450  | 600  |      |   |      |    |
|                      |   | TBU-KExxx-500-WH  | 500   | 750  | 1000 |      |   |      |    |
| R <sub>device</sub>  | Series resistance of the TBU® device  | V <sub>imp</sub> = 250 V I <sub>trigger</sub> (min.) = 50 mA  | TBU-KE025-050-WH  |      | 12.5 | 14.6 | Ω |      |    |
|                      |   | V <sub>imp</sub> = 250 V I <sub>trigger</sub> (min.) = 100 mA | TBU-KE025-100-WH  |      | 6.3  | 7.5  |   |      |    |
|                      |   | V <sub>imp</sub> = 250 V I <sub>trigger</sub> (min.) = 200 mA | TBU-KE025-200-WH  |      | 3.4  | 4.1  |   |      |    |
|                      |   | V <sub>imp</sub> = 250 V I <sub>trigger</sub> (min.) = 300 mA | TBU-KE025-300-WH  |      | 2.4  | 3.1  |   |      |    |
|                      |   | V <sub>imp</sub> = 250 V I <sub>trigger</sub> (min.) = 500 mA | TBU-KE025-500-WH  |      | 1.8  | 2.3  |   |      |    |
|                      |   | V <sub>imp</sub> = 400 V I <sub>trigger</sub> (min.) = 50 mA  | TBU-KE040-050-WH  |      | 13.0 | 15.2 |   |      |    |
|                      |   | V <sub>imp</sub> = 400 V I <sub>trigger</sub> (min.) = 100 mA | TBU-KE040-100-WH  |      | 6.8  | 8.1  |   |      |    |
|                      |   | V <sub>imp</sub> = 400 V I <sub>trigger</sub> (min.) = 200 mA | TBU-KE040-200-WH  |      | 3.9  | 4.7  |   |      |    |
|                      |   | V <sub>imp</sub> = 400 V I <sub>trigger</sub> (min.) = 300 mA | TBU-KE040-300-WH  |      | 3.0  | 3.7  |   |      |    |
|                      |   | V <sub>imp</sub> = 400 V I <sub>trigger</sub> (min.) = 500 mA | TBU-KE040-500-WH  |      | 2.3  | 2.9  |   |      |    |
|                      |   | V <sub>imp</sub> = 500 V I <sub>trigger</sub> (min.) = 50 mA  | TBU-KE050-050-WH  |      | 13.7 | 16.0 |   |      |    |
|                      |   | V <sub>imp</sub> = 500 V I <sub>trigger</sub> (min.) = 100 mA | TBU-KE050-100-WH  |      | 7.5  | 8.9  |   |      |    |
|                      |   | V <sub>imp</sub> = 500 V I <sub>trigger</sub> (min.) = 200 mA | TBU-KE050-200-WH  |      | 4.6  | 5.5  |   |      |    |
|                      |   | V <sub>imp</sub> = 500 V I <sub>trigger</sub> (min.) = 300 mA | TBU-KE050-300-WH  |      | 3.6  | 4.5  |   |      |    |
|                      |   | V <sub>imp</sub> = 500 V I <sub>trigger</sub> (min.) = 500 mA | TBU-KE050-500-WH  |      | 3.0  | 3.6  |   |      |    |
|                      |   | t <sub>block</sub>  | Time for the device to go from normal operating state to protected state                |      |      |      |   | 1    | μs |
|                      |   | I <sub>Q</sub>  | Current through the triggered TBU® device with 50 Vdc circuit voltage                   |      | 0.25 | 0.50 |   | 1.00 | mA |
|                      |   | V <sub>reset</sub>  | Voltage below which the triggered TBU® device will transition to normal operating state |      | 12   | 16   |   | 20   | V  |
| R <sub>th(j-l)</sub> | Junction to package pads - FR4 using recommended pad layout                   |   |   | 116  |      | °C/W |   |      |    |
| R <sub>th(j-l)</sub> | Junction to package pads - FR4 using heat sink on board (6 cm <sup>2</sup> )  |   |   | 96   |      | °C/W |   |      |    |

# TBU-KE Series - TBU® High Speed Protectors

**BOURNS®**

## Reference Application

The TBU® device can be used to protect against excessive voltage surges in DC biased equipment, as shown in the figure below. Diode D1 prevents reverse voltage surges from damaging the equipment, and the TBU® protector prevents any positive surges from causing damage. An overvoltage protection device, such as an MOV, may be used to provide additional overvoltage protection if the surge voltage is likely to be above the maximum rating of the TBU® device. D1 reverse voltage rating should be greater than that of the OVP device at the maximum surge current level. Typically, a 1N4007 is a suitable choice. D2 should be chosen to be above the normal working voltage of the protected device, but below its absolute maximum rating.

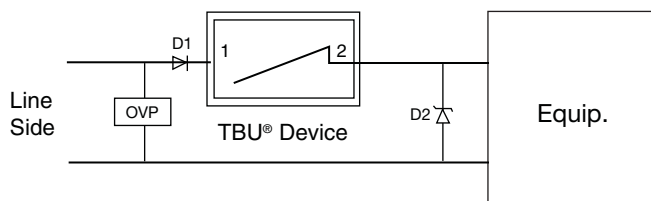

## Basic TBU Operation

The TBU® device is a silicon-based, solid-state, resettable device which is placed in series with a signal path. The TBU® device operates in approximately 1  $\mu$ s - once line current exceeds the TBU® device's trigger current  $I_{trigger}$ . When operated, the TBU® device restricts line current to less than 1 mA typically. When operated, the TBU® device will block all system voltages and any other voltages including the surge up to rated limits.

After the surge, the TBU® device resets when the voltage across the TBU® device falls to the  $V_{reset}$  level. The TBU® device will automatically reset on lines which have no DC bias or have DC bias below  $V_{reset}$  (such as unpowered signal lines).

If the line has a normal DC bias above  $V_{reset}$ , the voltage across the TBU® device may not fall below  $V_{reset}$  after the surge. In such cases, special care needs to be taken to ensure that the TBU® device will reset, otherwise an automatic or manual power down will be required. Bourns application engineers can provide further assistance.

## Performance Graphs

### V-I Characteristic - TBU-KE050-300-WH (Pin 2-1)

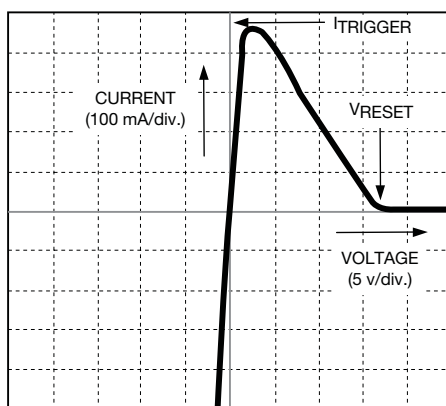

### Typical Trigger Current vs. Temperature

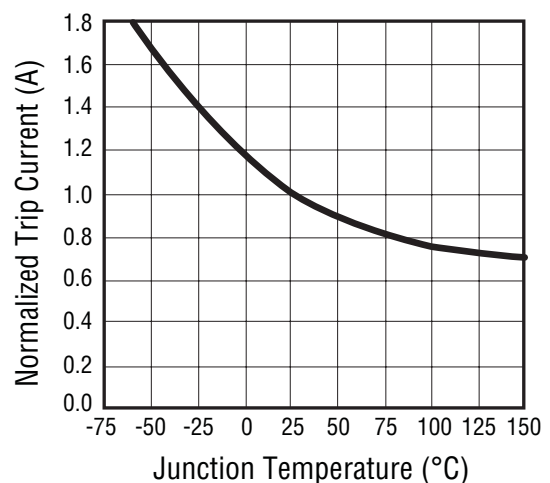

## Performance Graphs (Continued)

### Power Derating Curve

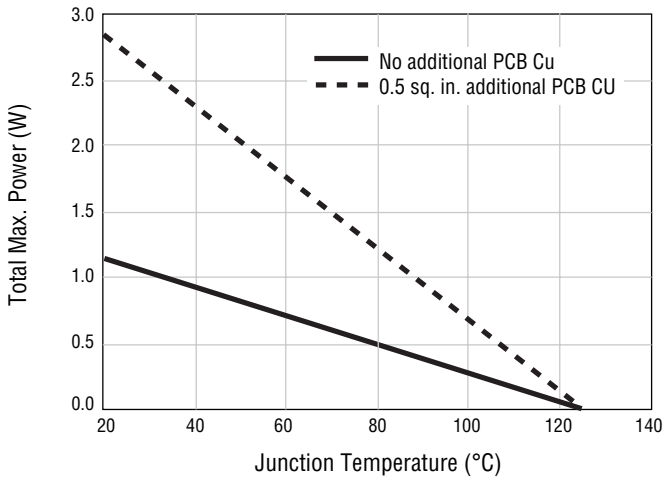

### Typical Resistance vs. Temperature

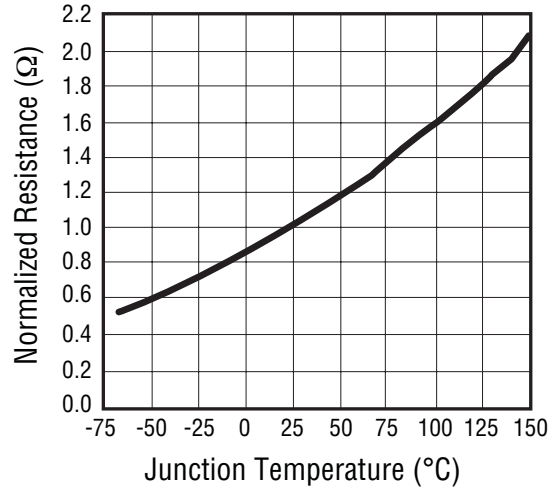

## Reflow Profile

| Profile Feature   | Pb-Free Assembly |
|---|------------------|
| Average Ramp-Up Rate (T <sub>smax</sub> to T <sub>p</sub> ) | 3 °C/sec. max.   |
| Preheat   |                  |
| - Temperature Min. (T <sub>smin</sub> )                     | 150 °C           |
| - Temperature Max. (T <sub>smax</sub> )                     | 200 °C           |
| - Time (t <sub>smin</sub> to t <sub>smax</sub> )            | 60-180 sec.      |
| Time maintained above:                                      |                  |
| - Temperature (T <sub>L</sub> )                             | 217 °C           |
| - Time (t <sub>L</sub> )                                    | 60-150 sec.      |
| Peak/Classification Temperature (T <sub>p</sub> )           | 260 °C           |
| Time within 5 °C of Actual Peak Temp. (t <sub>p</sub> )     | 20-40 sec.       |
| Ramp-Down Rate  | 6 °C/sec. max.   |
| Time 25 °C to Peak Temperature                              | 8 min. max.      |

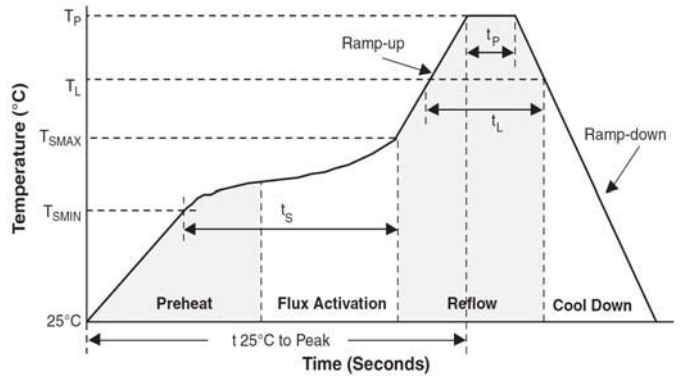

# TBU-KE Series - TBU® High Speed Protectors

**BOURNS®**

## Product Dimensions

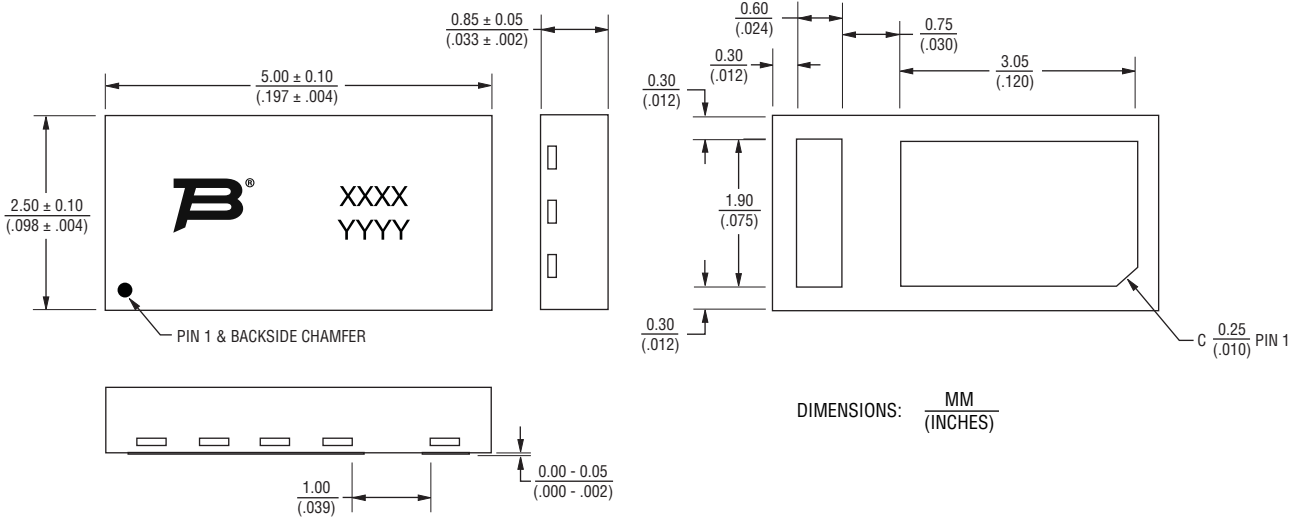

## Recommended Pad Layout

TBU® protectors have matte-tin termination finish. The suggested layout should use Non-Solder Mask Define (NSMD). The recommended stencil thickness is 0.10-0.12 mm (.004-.005 in.) with a stencil opening size 0.025 mm (.0010 in.) less than the device pad size. As when heat sinking any power device, it is recommended that wherever possible, extra PCB copper area is allowed. For minimum parasitic capacitance, do not allow any signal, ground or power signals beneath any of the pads of the device.

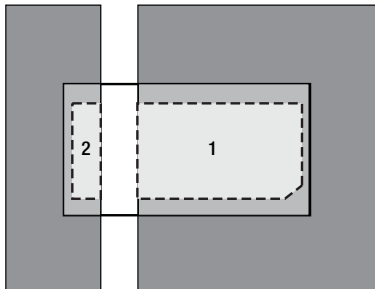

### Pad Designation

| Pad # | Pin Out   |
|-------|-----------|
| 1     | Line Side |
| 2     | Load Side |

Dark grey areas show added PCB copper area for better thermal resistance.

## Thermal Resistance vs. Additional PCB Cu Area

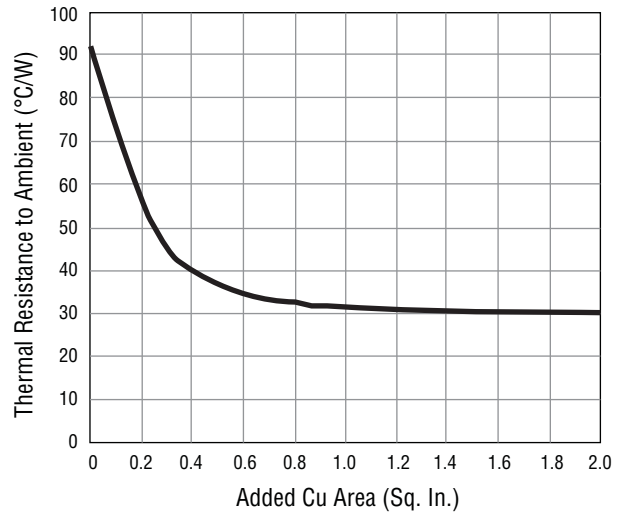

# TBU-KE Series - TBU® High Speed Protectors

# BOURNS®

## How to Order

TBU - KE 025 - 500 - WH

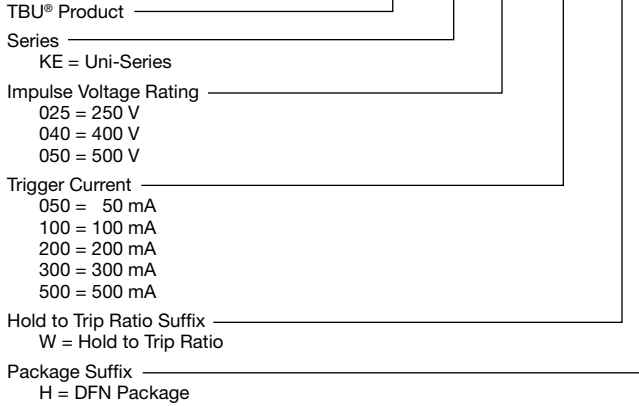

## Typical Part Marking

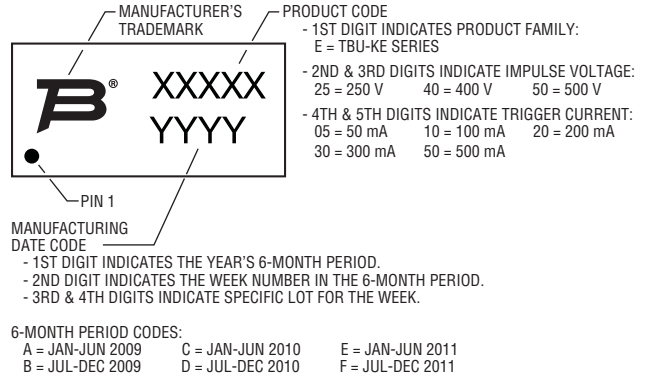

## Packaging Specifications

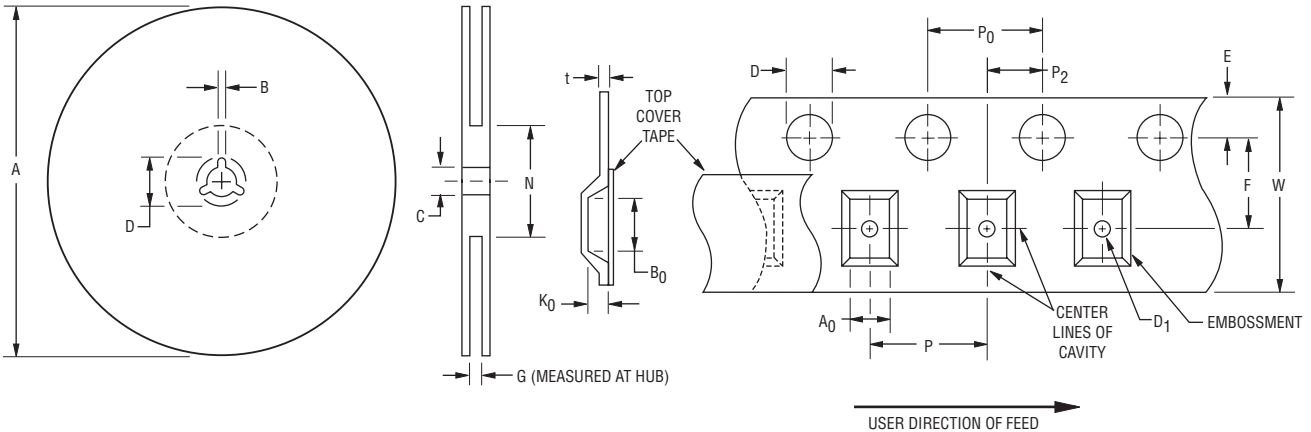

QUANTITY: 3000 PIECES PER REEL

| A       |         | B      |        | C      |        | D      |      | G      | N       |
|---------|---------|--------|--------|--------|--------|--------|------|--------|---------|
| Min.    | Max.    | Min.   | Max.   | Min.   | Max.   | Min.   | Max. | Ref.   | Ref.    |
| 176     | 178     | 1.5    | 2.5    | 12.8   | 13.5   | 20.2   | -    | 16.5   | 102     |
| (6.929) | (7.008) | (.059) | (.098) | (.504) | (.531) | (.795) |      | (.650) | (4.016) |

| A0     |        | B0     |        | D      |        | D1     |        | E      |        | F      |        |
|--------|--------|--------|--------|--------|--------|--------|--------|--------|--------|--------|--------|
| Min.   | Max.   | Min.   | Max.   | Min.   | Max.   | Min.   | Max.   | Min.   | Max.   | Min.   | Max.   |
| 4.2    | 4.4    | 6.65   | 7.05   | 1.5    | 1.6    | 1.5    | -      | 1.65   | 1.85   | 7.4    | 7.6    |
| (.165) | (.173) | (.262) | (.277) | (.059) | (.063) | (.059) |        | (.065) | (.073) | (.291) | (.299) |
| K0     |        | P      |        | P0     |        | P2     |        | t      |        | W      |        |
| Min.   | Max.   | Min.   | Max.   | Min.   | Max.   | Min.   | Max.   | Min.   | Max.   | Min.   | Max.   |
| 1.1    | 1.3    | 7.9    | 8.1    | 3.9    | 4.1    | 1.9    | 2.1    | 0.25   | 0.35   | 15.7   | 16.3   |
| (.043) | (.051) | (.311) | (.319) | (.159) | (.161) | (.075) | (.083) | (.010) | (.014) | (.618) | (.642) |

DIMENSIONS:  $\frac{\text{MM}}{\text{(INCHES)}}$

12/10

"TBU" is a registered trademark of Bourns, Inc. in the U.S., Taiwan and European Community. Specifications are subject to change without notice. Customers should verify actual device performance in their specific applications.

## Looking for pricing, stock, or lifecycle information?

Click below to explore more details on WIN SOURCE:

- ⊖ [View TBU-KE050-500-WH on WIN SOURCE](#)
- ⊖ [Bourns Inc. Information](#)

## Optimize Your Supply Chain with WIN SOURCE Solutions

- ✓ Global Sourcing Solution
- ✓ Obsolete Management
- ✓ Cost Control Management
- ✓ Shortage Management
- ✓ Alternative Solution
- ✓ Excess Inventory Management