

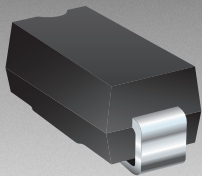

**THE DATASHEET OF
CD214B-F2600**



*RoHS COMPLIANT



BOURNS®

Features

- RoHS compliant*
- Glass passivated chip
- Low reverse leakage current
- Low forward voltage drop
- High current capability



This series is currently available but not recommended for new designs. The [Model CD214B-FS2x Series](#) is the recommended replacement.

CD214B-F250~F2600 Surface Mount Fast Response Rectifiers

General Information

The markets of portable communications, computing and video equipment are challenging the semiconductor industry to develop increasingly smaller electronic components. Bourns offers Surface Mount Fast Response Rectifiers for rectification applications, in compact chip DO-214AA (SMB) size format, which offer PCB real estate savings and are considerably smaller than most competitive parts. The Fast Response Rectifier Diodes offer a forward current of 2.0 A with a choice of repetitive peak reverse voltages of 50 V up to 600 V.

Bourns® Chip Diodes conform to JEDEC standards, are easy to handle on standard pick and place equipment and their flat configuration minimizes roll away.

Electrical Characteristics (@ T_A = 25 °C Unless Otherwise Noted)

Parameter	Symbol	CD214B-						Unit
		F250	F2100	F2150	F2200	F2400	F2600	
Maximum Repetitive Peak Reverse Voltage	V _{RRM}	50	100	150	200	400	600	V
Maximum RMS Voltage	V _{RMS}	35	70	105	140	280	420	V
Maximum DC Blocking Voltage	V _{DC}	50	100	150	200	400	600	V
Max. Average Forward Rectified Current ¹	I _(AV)	2.0						A
DC Reverse Current @ Rated DC Blocking Voltage (@ T _J = 25 °C)	I _R	5.0						μA
DC Reverse Current @ Rated DC Blocking Voltage (@ T _J = 125 °C)	I _R	350						μA
Typical Junction Capacitance ²	C _J	200						pF
Maximum Instantaneous Forward Voltage @ 1 A	V _F	0.92			1.25	1.30		V
Typical Thermal Resistance ³	R _{θJL}	15						°C/W
Peak forward surge current 8.3 ms single half sine-wave superimposed on rated load (JEDEC Method)	I _{FSM}	50						A

Notes:

1 See Figure 1.

2 Measured @ 1.0 MHz and applied reverse voltage of 4.0 VDC.

3 Thermal resistance from junction to ambient and from junction to lead P.C.B. mounted on 0.2" x 0.2" (5.0 mm x 5.0 mm) copper pad areas.

Thermal Characteristics (@ T_A = 25 °C Unless Otherwise Noted)

Parameter	Symbol	CD214B-F250-F2600	Unit
Operating Temperature Range	T _J	-55 to +125	°C
Storage Temperature Range	T _{STG}	-55 to +150	°C

*RoHS Directive 2002/95/EC Jan. 27, 2003 including annex and RoHS Recast 2011/65/EU June 8, 2011.

Specifications are subject to change without notice.

The device characteristics and parameters in this data sheet can and do vary in different applications and actual device performance may vary over time. Users should verify actual device performance in their specific applications.

CD214B-F250~F2600 Surface Mount Fast Response Rectifiers



Product Dimensions

This is an RoHS compliant product. It is a molded plastic package. A cathode band indicates the polarity. The package weighs approximately 0.064 g. The package and dimensions are shown below.

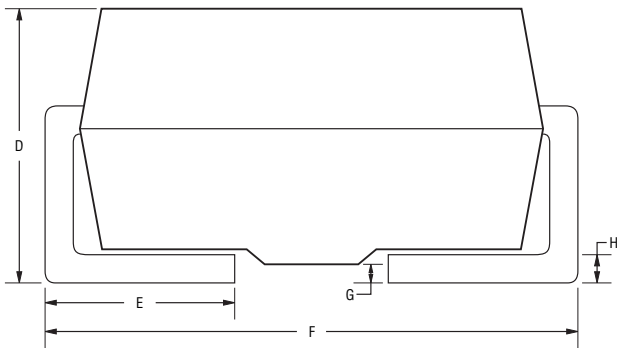
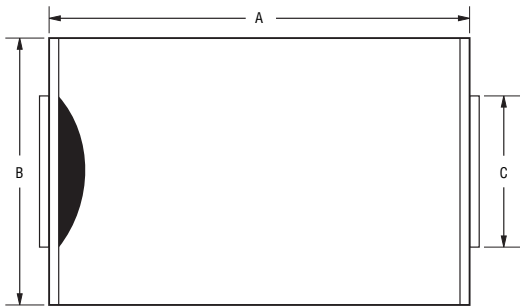

Dimensions	
A	$\frac{4.06 - 4.57}{(0.167 - 0.187)}$
B	$\frac{3.30 - 3.94}{(0.130 - 0.150)}$
C	$\frac{1.96 - 2.21}{(0.075 - 0.087)}$
D	$\frac{2.01 - 2.62}{(0.079 - 0.096)}$
E	$\frac{0.76 - 1.52}{(0.039 - 0.055)}$
F	$\frac{5.21 - 5.59}{(0.197 - 0.236)}$
G	$\frac{0.05 - 0.20}{(0.00196 - 0.00787)}$
H	$\frac{0.15 - 0.31}{(0.006 - 0.016)}$

DIMENSIONS: $\frac{\text{MM}}{\text{(INCHES)}}$

Recommended Pad Layout

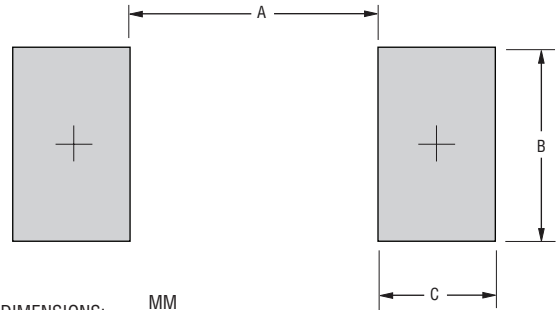

DIMENSIONS: $\frac{\text{MM}}{\text{(INCHES)}}$

Dimension	SMA (DO-214AC)
A	$\frac{2.90}{(0.114)}$
B	$\frac{3.00}{(0.118)}$
C	$\frac{2.30}{(0.091)}$

How To Order

CD 214B - F 2 50

Common Code _____
 Chip Diode _____
 Package _____
 • 214B = SMB/DO-214AA
 Model _____
 F = Fast Response Rectifiers
 Forward Current I_{AV} _____
 2 = 2 A
 Reverse Voltage _____
 50 = 50 V
 100 = 100 V
 150 = 150 V
 200 = 200 V
 400 = 400 V
 600 = 600 V

Specifications are subject to change without notice. The device characteristics and parameters in this data sheet can and do vary in different applications and actual device performance may vary over time. Users should verify actual device performance in their specific applications.

CD214B-F250~F2600 Surface Mount Fast Response Rectifiers



Rating and Characteristic Curves

Forward Current Derating Curve

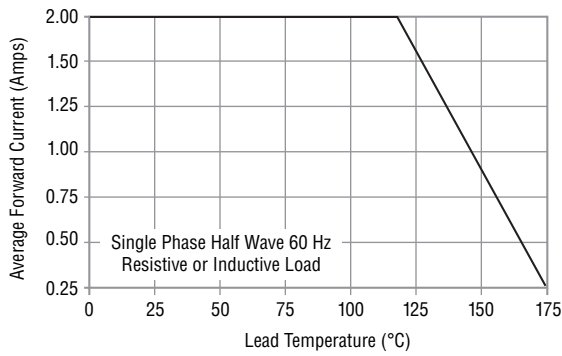

Non-Repetitive Surge Current

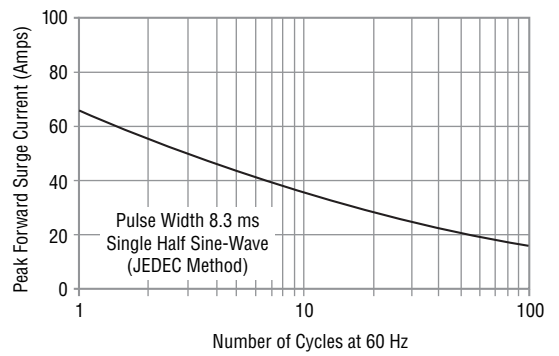

Forward Characteristics

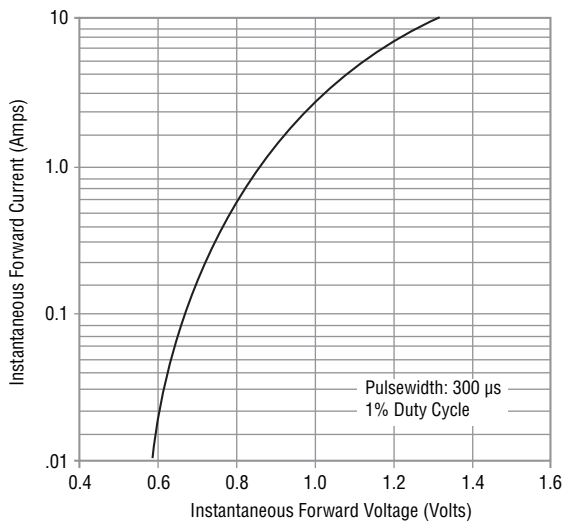

Reverse Characteristics

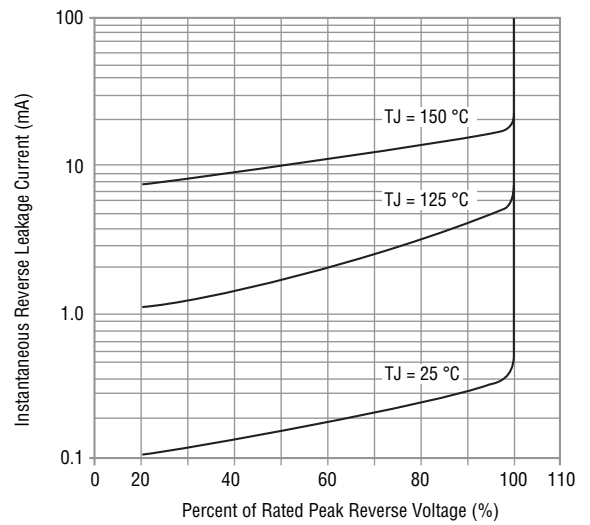

Specifications are subject to change without notice.
The device characteristics and parameters in this data sheet can and do vary in different applications and actual device performance may vary over time.
Users should verify actual device performance in their specific applications.

CD214B-F250~F2600 Surface Mount Fast Response Rectifiers

BOURNS®

Packaging Information

The surface mount product is packaged in an 8 mm x 4 mm tape and reel format per EIA-481 standard.

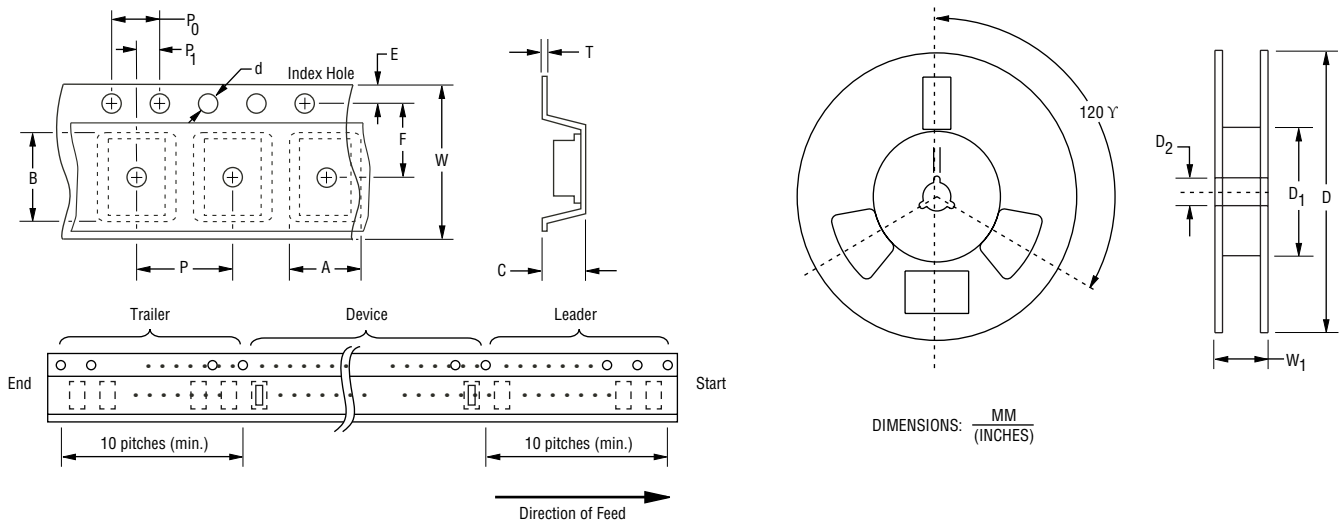

DIMENSIONS: $\frac{\text{MM}}{\text{(INCHES)}}$

Item	Symbol	DO-214AA (SMB)
Carrier Width	A	$\frac{1.90 \pm 0.10}{(0.075 \pm 0.004)}$
Carrier Length	B	$\frac{4.30 \pm 0.10}{(0.169 \pm 0.004)}$
Carrier Depth	C	$\frac{1.80 \pm 0.10}{(0.071 \pm 0.004)}$
Sprocket Hole	d	$\frac{1.55 \pm 0.05}{(0.061 \pm 0.002)}$
Reel Outside Diameter	D	$\frac{178}{(7.008)}$
Reel Inner Diameter	D ₁	$\frac{80.0}{(3.150)}$ MIN.
Feed Hole Diameter	D ₂	$\frac{13.0 \pm 0.20}{(0.512 \pm 0.008)}$
Sprocket Hole Position	E	$\frac{1.75 \pm 0.10}{(0.069 \pm 0.004)}$
Punch Hole Position	F	$\frac{3.50 \pm 0.05}{(0.138 \pm 0.002)}$
Punch Hole Pitch	P	$\frac{4.00 \pm 0.10}{(0.157 \pm 0.004)}$
Sprocket Hole Pitch	P ₀	$\frac{4.00 \pm 0.10}{(0.157 \pm 0.004)}$
Embossment Center	P ₁	$\frac{2.00 \pm 0.05}{(0.079 \pm 0.002)}$
Overall Tape Thickness	T	$\frac{0.20 \pm 0.10}{(0.008 \pm 0.004)}$
Tape Width	W	$\frac{8.00 \pm 0.20}{(0.315 \pm 0.008)}$
Reel Width	W ₁	$\frac{13.5}{(0.531)}$ MIN.
Quantity per Reel	—	3,000

REV. 01/18

Specifications are subject to change without notice.

The device characteristics and parameters in this data sheet can and do vary in different applications and actual device performance may vary over time. Users should verify actual device performance in their specific applications.

Looking for pricing, stock, or lifecycle information?

Click below to explore more details on WIN SOURCE:

 [View CD214B-F2600 on WIN SOURCE](#)

 [Bourns Inc. Information](#)

Optimize Your Supply Chain with WIN SOURCE Solutions

-  Global Sourcing Solution
-  Obsolete Management
-  Cost Control Management
-  Shortage Management
-  Alternative Solution
-  Excess Inventory Management