

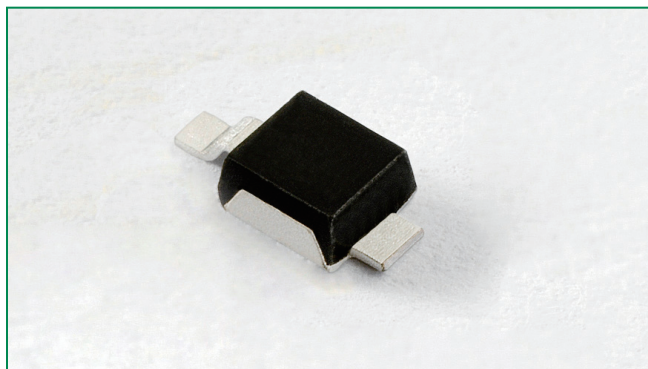

# THE DATASHEET OF PLED6M





**Description**

The open LED protector provides a switching electronic shunt path when an LED in an LED string fails as an open circuit. This ensures that the entire array of LEDs will continue to function even if a single LED in the array does not. This provides higher reliable lighting functions in applications such as headlights, aircraft lights, airport runway lighting, roadside warning lights, etc. This device is designed to be used with one watt LEDs, nominally 350mA @ 3V, and is available in POWERMITE® package (CSP) which is ideal for dense board applications.

**Pinout Diagram**

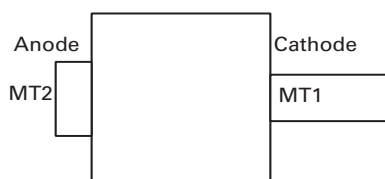

**Features & Benefits**

- Fast switching
- Automatically resets after power cycle
- Available in low profile, small footprint POWERMITE® packages
- Compatible with industrial lighting environments
- Compatible with PWM frequencies up to 10 kHz
- RoHS compliant and halogen-free

**Schematic Symbol**

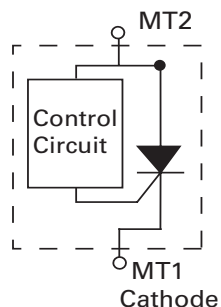

**Electrical Characteristics(All parameters are measured at T<sub>A</sub>=25°C unless otherwise noted)**

Part Number	Marking	V <sub>BR</sub> @ I <sub>BR</sub> = 1 mAmps		I <sub>LEAK</sub> @ I <sub>MT2</sub> = 5V	I <sub>H</sub>	I <sub>S</sub>	I <sub>T</sub> @V <sub>T</sub>	V <sub>T</sub> @ I <sub>T</sub> = 350mA	V <sub>T</sub> @ I <sub>T</sub> = 1A	V <sub>T</sub> @ I <sub>T</sub> = 1.3A	Critical rate of rise dV/dt	Capacitance @ 1MHz, 2V bias
		Volts		uA	mA	mA	A	V	V	V		
		Min	Max	Max	Max	Max	Max	Max	Typ	Typ		
PLED6M	P6M	5.5	7.5	250	12	70	1.0 <sup>1,2</sup>	1.2	1.15	1.2	250	24

Notes:

- 1) Standard FR-4 PCB with Copper Pads (2mm x 2mm/pad)
- 2) Aluminum PCB Pads (2mm x 3mm/pad)

**Thermal Considerations**

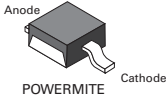
Package	Symbol	Parameter	Value	Unit
 <p>POWERMITE</p>	$I_T$	Average On-State Current, ( $T_A = 25^\circ\text{C}$ )	1.0 <sup>1 2</sup>	A
	$V_T$	On-state Voltage ( $T_A = 125^\circ\text{C}$ )	1.0	V
	$P_D$	Power Dissipation ( $T_A = 25^\circ\text{C}$ )	1.45 <sup>1</sup>	W
			1.50 <sup>2</sup>	
	$T_J$	Operating Junction Temperature Range	80 <sup>1</sup>	$^\circ\text{C}$
			50 <sup>2</sup>	
	$T_S$	Storage Temperature Range	-65 to +150	$^\circ\text{C}$
	$R_{\theta JL}$	Thermal Resistance: Junction to Lead	25 <sup>1</sup>	$^\circ\text{C}/\text{W}$
20 <sup>2</sup>				
$R_{\theta JA}$	Thermal Resistance: Junction to Ambient	80 <sup>1</sup>	$^\circ\text{C}/\text{W}$	
		50 <sup>2</sup>		

Notes:

- 1) Standard FR-4 PCB with Copper Pads (2mm x 2mm/pad)
- 2) Aluminum PCB Pads (2mm x 3mm/pad)
- \* POWERMITE® is a registered trademark of Microsemi Corporation.

**V-I Characteristics**

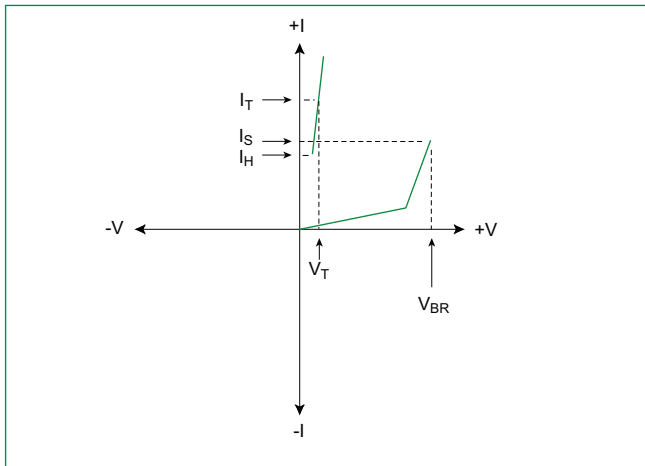

**$V_{BR}$  vs. Junction Temperature**

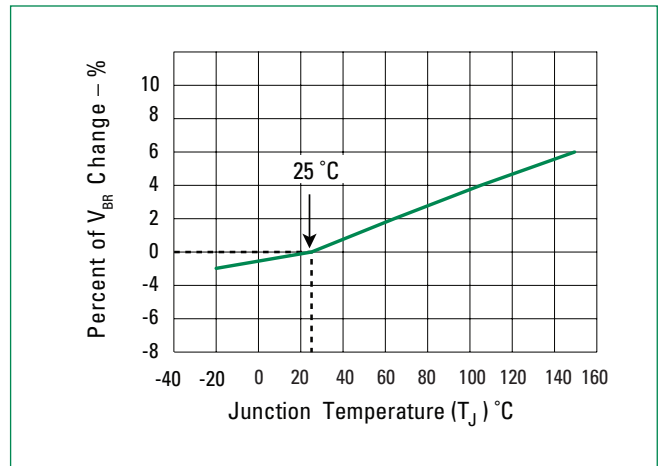

**Normalized DC Holding Current vs. Ambient Temperature**

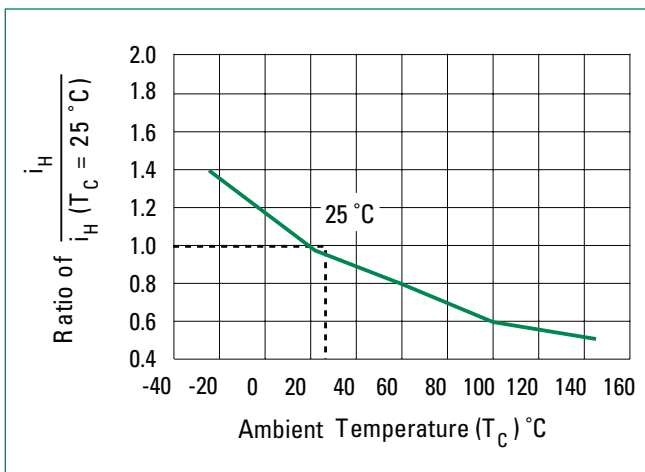

**Capacitance vs Voltage**

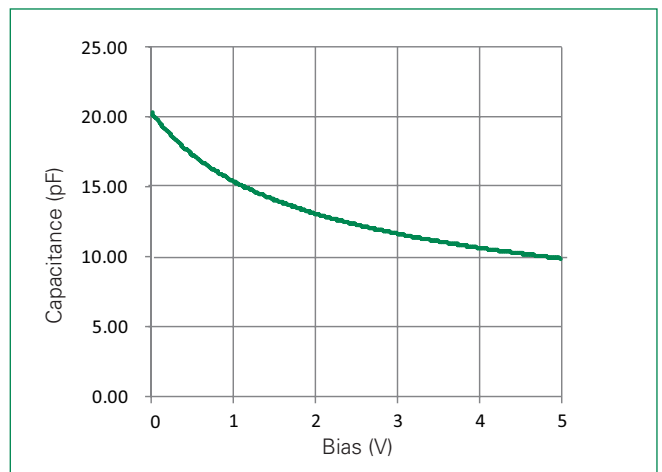

**Leakage Current vs Temperature**

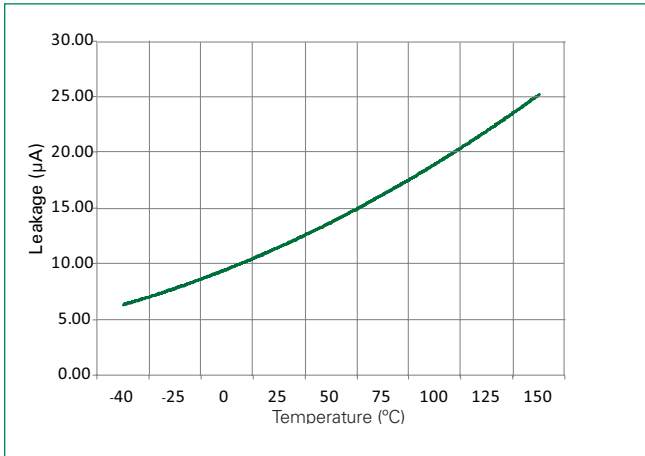

**LED Interference Test Circuit**

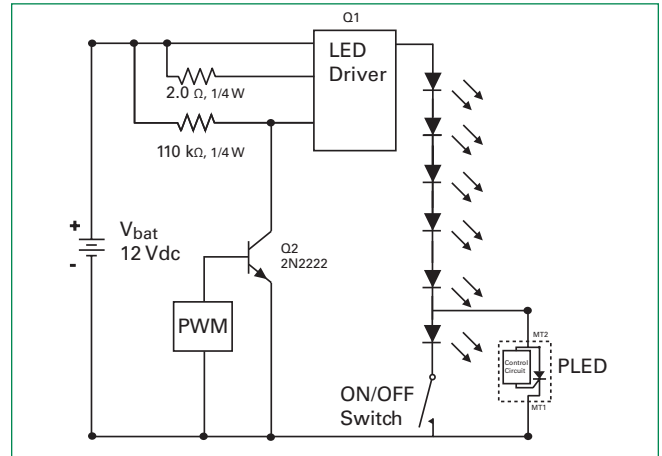

**Operating Current vs. Ambient Temperature**

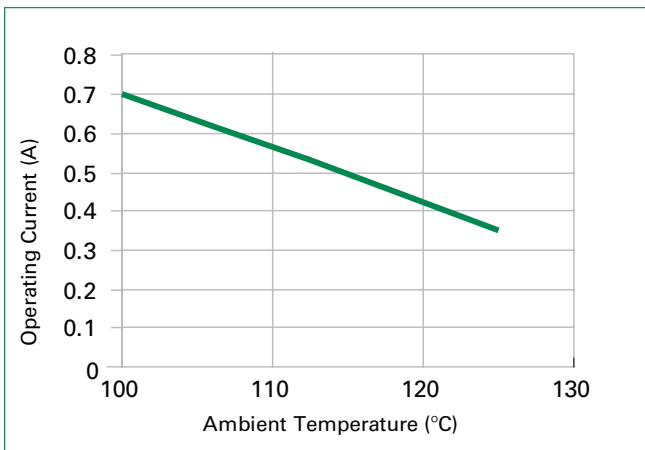

**Typical Operation Waveforms**

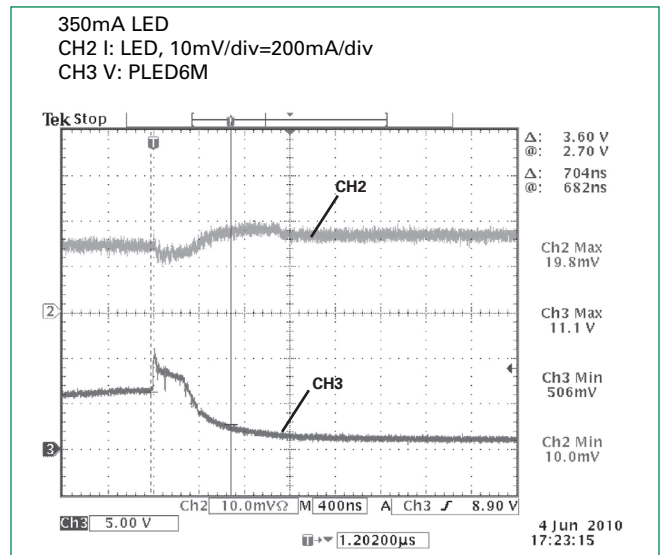
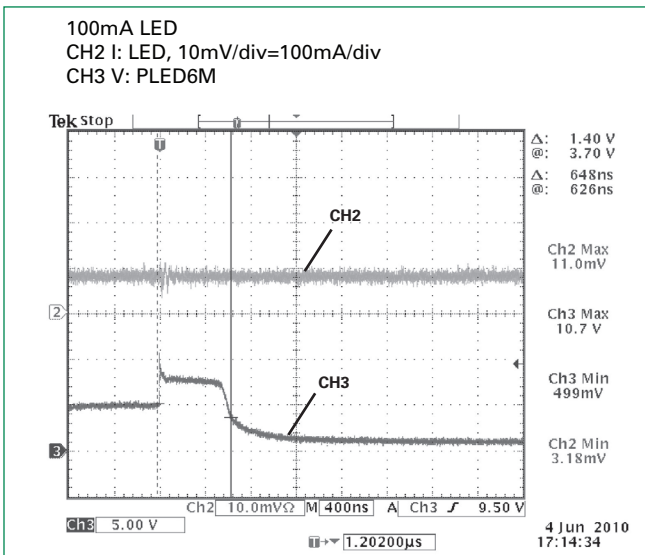

**Soldering Parameters**

Reflow Condition		Pb – Free assembly
Pre Heat	- Temperature Min ( $T_{s(min)}$ )	150°C
	- Temperature Max ( $T_{s(max)}$ )	200°C
	- Time (min to max) ( $t_s$ )	60 – 180 secs
Average ramp up rate (Liquidus Temp ( $T_L$ ) to peak)		3°C/second max
$T_{s(max)}$ to $T_L$ - Ramp-up Rate		3°C/second max
Reflow	- Temperature ( $T_L$ ) (Liquidus)	217°C
	- Temperature ( $t_L$ )	60 – 150 seconds
Peak Temperature ( $T_p$ )		260 <sup>+0/-5</sup> °C
Time within 5°C of actual peak Temperature ( $t_p$ )		30 seconds
Ramp-down Rate		6°C/second max
Time 25°C to peak Temperature ( $T_p$ )		8 minutes max
Do not exceed		260°C

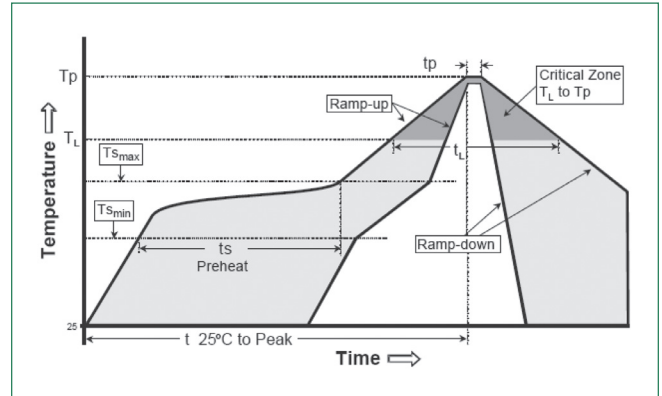

**Physical Specifications**

<b>Terminal Material</b>	Copper Alloy
<b>Terminal Finish</b>	100% Matte Tin Plated
<b>Body Material</b>	UL recognized epoxy meeting flammability classification 94V-0

**Packaging**

Package Code	Description	Packaging Quantity	Industry Standard
M	POWERMITE	3000	EIA-481-1 Tape and Reel

**Part Numbering System**

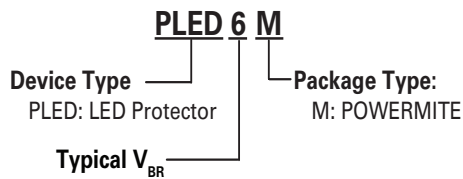

**Environmental Specifications**

<b>High Temperature Voltage Blocking</b>	MIL-STD-750: Method 1040, Condition A 80% min $V_{BR}$ DC, 150°C, 504 hours
<b>Temperature Cycling</b>	MIL-STD-750: Method 1051 -65°C to 150°C, 15-minute dwell, 100 cycles
<b>Biased Temperature &amp; Humidity</b>	EIA/JEDEC: JESD22-A101 80% min $V_{BR}$ , 85°C, 85% RH, 1008 hours
<b>Resistance to Solder Heat</b>	MIL-STD-750: Method 2031 260°C, 10 seconds
<b>Moisture Sensitivity Level</b>	JEDEC-J-STD-020, Level 1
<b>Burn-In Test</b>	$T_j = 150^\circ\text{C}$ , $IT = 0.350$ Adc, 1008 hours

**Part Marking System**

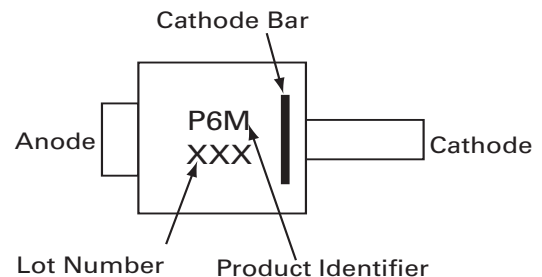

**Dimensions - POWERMITE® Package**

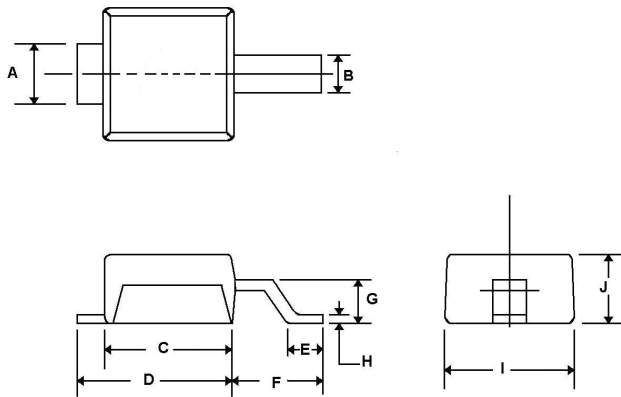

Dimensions	Millimeters		Inches	
	Min	Max	Min	Max
A	0.73	0.99	0.029	0.039
B	0.40	0.66	0.016	0.026
C	1.77	2.03	0.070	0.080
D	2.21	2.46	0.087	0.097
E	0.50	0.76	0.020	0.030
F	1.29	1.54	0.051	0.061
G	0.53	0.78	0.021	0.031
H	0.10	0.20	0.004	0.008
I	1.77	2.03	0.070	0.080
J	0.89	1.14	0.035	0.045

**Tape and Reel Specification - POWERMITE® Package**

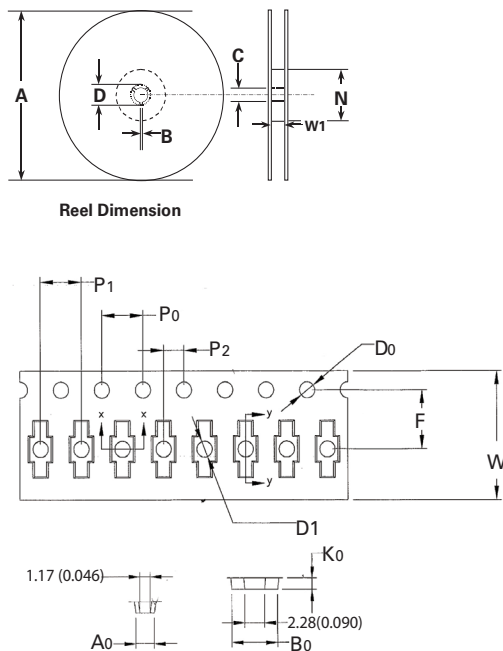

Symbols	Description	Inches			Millimeters		
		MIN	TYP	MAX	MIN	TYP	MAX
A	Reel Diameter	-	-	7.087	-	-	180.00
B	Drive Spoke Width	0.098	0.157	0.217	2.50	4.00	5.50
C	Arbor Hole Diameter	0.504	0.512	0.520	12.80	13.00	13.20
D	Drive Spoke Diameter	0.795	-	-	20.20	-	-
N	Hub Diameter	2.343	2.362	2.382	59.50	60.00	60.50
W1	Reel Inner Width at Hub	0.472	0.488	0.508	12.00	12.40	12.90
A0	Pocket Width at Bottom	0.078	0.082	0.086	1.98	2.08	2.18
B0	Pocket Length at Bottom	0.198	0.202	0.206	5.04	5.14	5.24
D0	Feed Hole Diameter	0.055	0.059	0.063	1.40	1.50	1.60
D1	Pocket Hole Diameter	0.053	0.059	0.069	1.35	1.50	1.75
F	Feed Hole Center-Pocket Hole Center 2	0.197	0.217	0.236	5.00	5.50	1.60
K0	Pocket Depth	0.044	0.048	0.052	1.11	1.21	1.31
P0	Feed Hole Pitch	0.154	0.157	0.161	3.90	4.00	4.10
P1	Component Spacing	0.154	0.157	0.161	3.90	4.00	4.10
P2	Feed Hole Center-Pocket Hole Center 1	0.077	0.079	0.081	1.95	2.00	2.05
W	Embossed Carrier Tape Width	0.469	0.472	0.484	11.90	12.00	12.30
	Cover Tape Width	-	0.366	-	-	9.30	-

## Looking for pricing, stock, or lifecycle information?

Click below to explore more details on WIN SOURCE:

 [View PLED6M on WIN SOURCE](#)

 [Littelfuse Inc. Information](#)

## Optimize Your Supply Chain with WIN SOURCE Solutions

-  Global Sourcing Solution
-  Obsolete Management
-  Cost Control Management
-  Shortage Management
-  Alternative Solution
-  Excess Inventory Management