



**THE DATASHEET OF
C13055_EMMA-360**



EMMA-360

~170° side emitter

TECHNICAL SPECIFICATIONS:

Dimensions	9.9 mm
Height	5.7 mm
Fastening	glue, pin
Colour	clear
Box size	
Box weight	2 kg
Quantity in Box	5000 pcs
ROHS compliant	yes ⓘ



MATERIAL SPECIFICATIONS:

Component	Type	Material	Colour
EMMA-360	Single lens	PMMA	clear

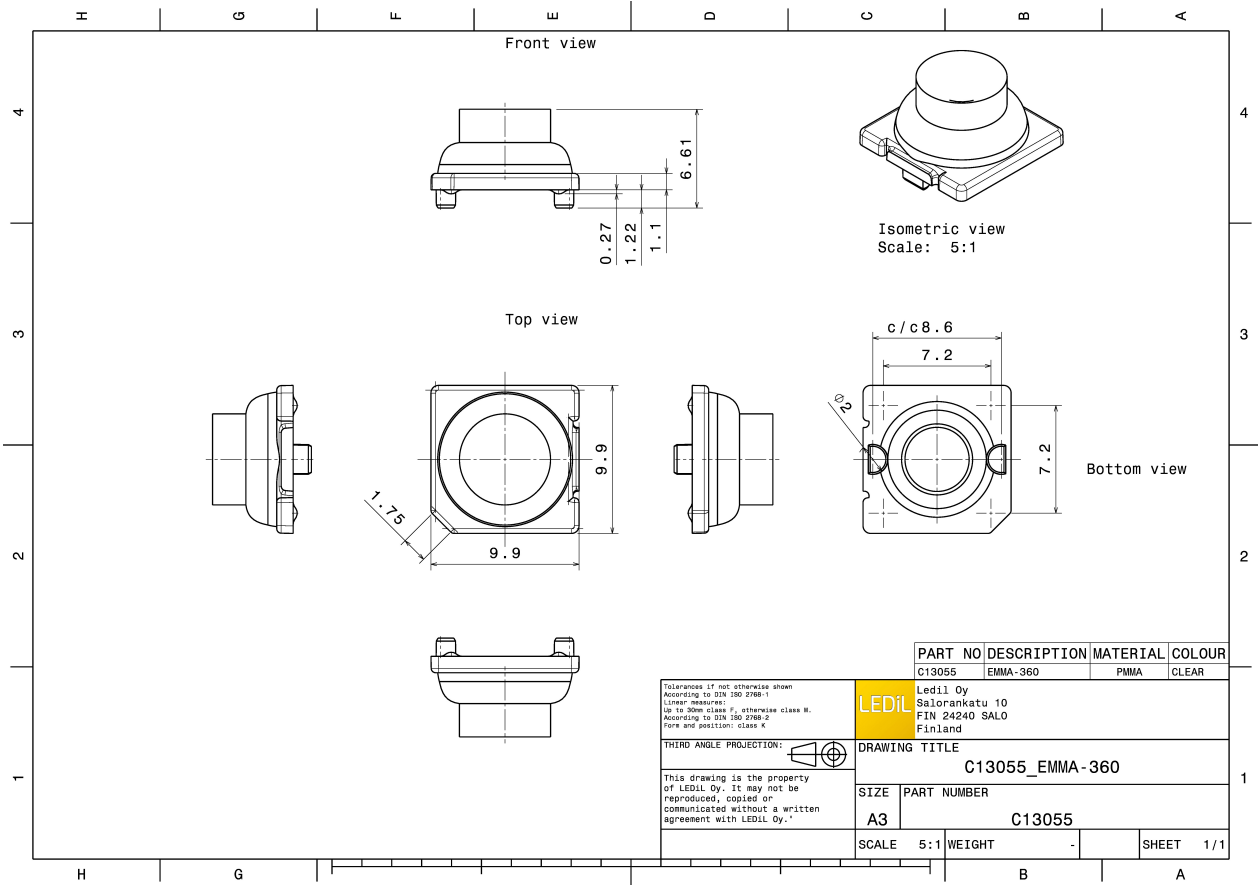

PHOTOMETRIC DATA (MEASURED):

CREE ⇄

LED XB-D
FWHM 170.0°
Efficiency 93 %
Peak intensity 0.440 cd/lm
LEDs/each optic 1
Light colour White
Required components:

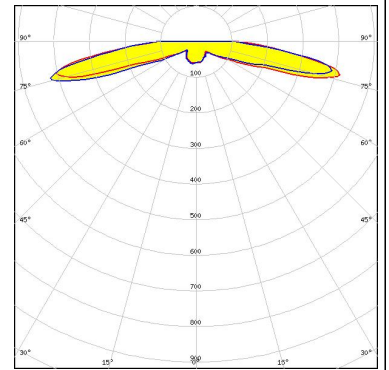

CREE ⇄

LED XP-E2
FWHM 172.0°
Efficiency 94 %
Peak intensity 0.430 cd/lm
LEDs/each optic 1
Light colour White
Required components:

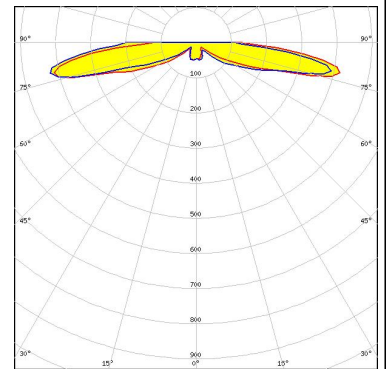

CREE ⇄

LED XP-G
FWHM 173.0°
Efficiency 88 %
Peak intensity 0.390 cd/lm
LEDs/each optic 1
Light colour White
Required components:

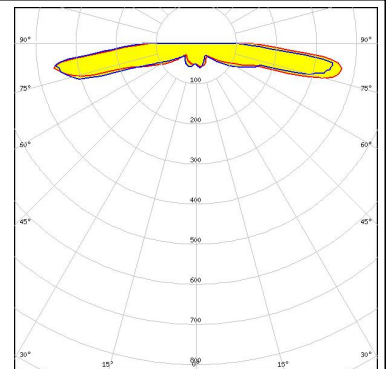

CREE ⇄

LED XP-G2
FWHM 172.0°
Efficiency 90 %
Peak intensity 0.410 cd/lm
LEDs/each optic 1
Light colour White
Required components:

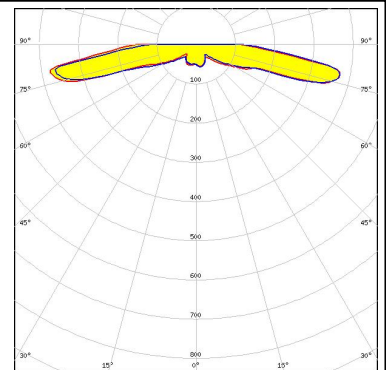

PHOTOMETRIC DATA (MEASURED):



LED XT-E
FWHM 174.0°
Efficiency 94 %
Peak intensity 0.400 cd/lm
LEDs/each optic 1
Light colour White
Required components:

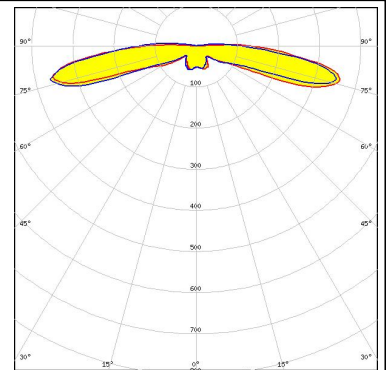

LED LUXEON 3535 2D
FWHM 170.0°
Efficiency 94 %
Peak intensity 0.430 cd/lm
LEDs/each optic 1
Light colour White
Required components:

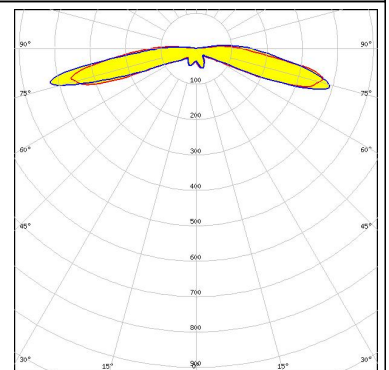

LED LUXEON A
FWHM 173.0°
Efficiency 92 %
Peak intensity 0.370 cd/lm
LEDs/each optic 1
Light colour White
Required components:

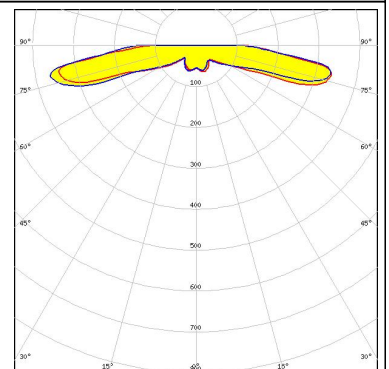

LED LUXEON Rebel
FWHM 165.0°
Efficiency 93 %
Peak intensity 0.530 cd/lm
LEDs/each optic 1
Light colour White
Required components:

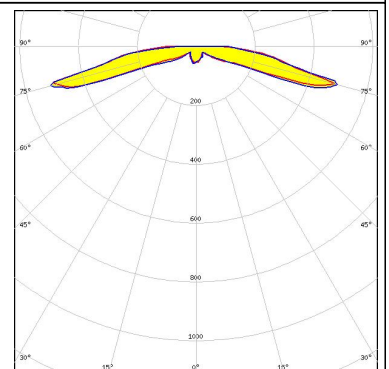

PHOTOMETRIC DATA (MEASURED):



LED NCSxx19A
FWHM 165.0°
Efficiency 90 %
Peak intensity 0.420 cd/lm
LEDs/each optic 1
Light colour White
Required components:

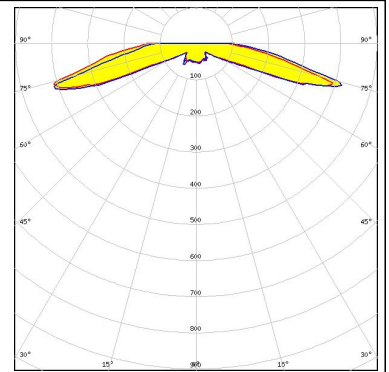

LED Oslon Square EC
FWHM 170.0°
Efficiency 92 %
Peak intensity 0.420 cd/lm
LEDs/each optic 1
Light colour White
Required components:

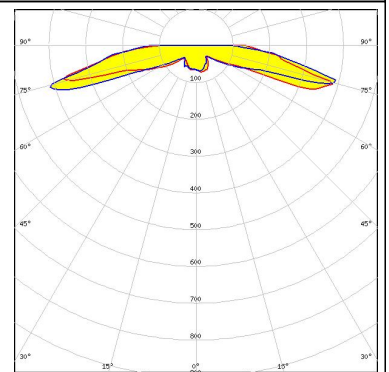

PHOTOMETRIC DATA (SIMULATED):

LUMILEDS

LED LUXEON C
FWHM 174.0°
Efficiency 94 %
Peak intensity 0.510 cd/lm
LEDs/each optic 1
Light colour Red
Required components:

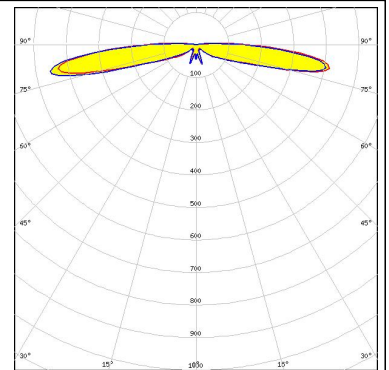

LUMILEDS

LED LUXEON CZ
FWHM 167.0°
Efficiency 94 %
Peak intensity 0.640 cd/lm
LEDs/each optic 1
Light colour Red
Required components:

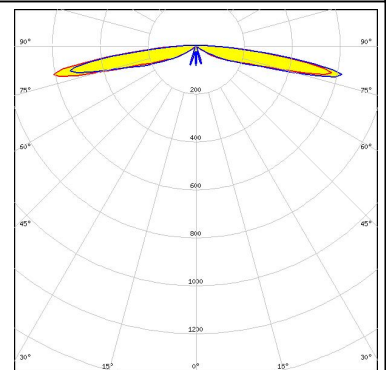

LUMILEDS

LED LUXEON V2
FWHM 172.0°
Efficiency 94 %
Peak intensity 0.380 cd/lm
LEDs/each optic 1
Light colour White
Required components:

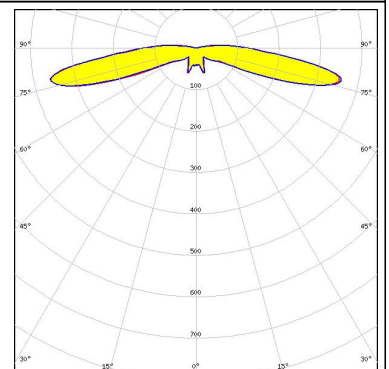

SEOL SEOUL SEMICONDUCTOR

LED Z8Y22P
FWHM 152.0°
Efficiency 87 %
Peak intensity 0.350 cd/lm
LEDs/each optic 1
Light colour White
Required components:

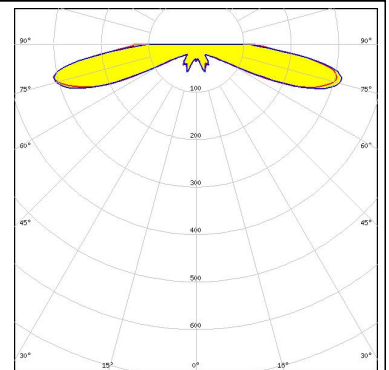

GENERAL INFORMATION:

NOTE: The typical beam angle will be changed by different color, chip size and chip position tolerance. The typical total beam angle is the full angle measured where the luminous intensity is half of the peak value.

MATERIALS:

As part of our continuous research and improvement processes, and to ensure the best possible quality and availability of our products, LEDiL reserves the right to change material grades without notice.

PRODUCT DATA USER AGREEMENT AND DISCLAIMER:

The measured data in the provided downloadable LEDiL Product Datasheets and Mechanical 2D-Drawings is rounded and provided as reference for planning. LEDiL Oy's optical specifications have been verified by conducting performance testing of the products in accordance with the company's quality system. The reported data are averaged results of multiple measurements with typical variation. LEDiL Oy reserves the right to without prior notification make changes and improvements to its products.

LEDiL Oy assumes neither warranty, nor guarantee nor any other liability of any kind for the contents and correctness of the provided data. The provided data has been generated with highest diligence but the provided data may in reality not represent the complete possible variation range of all intrinsic parameters. Therefore, in certain cases a deviation from the provided data could occur.

LEDiL Oy reserves the right to undertake technical changes of its products without further notification which could lead to changes in the provided data. LEDiL Oy assumes no liability of any kind for the possible deviation from any provided data or any other damage resulting from the usage of the provided data.

The user agrees to this disclaimer and user agreement with the download or usage of the provided files.

LEDiL Oy

Joensuunkatu 13
FI-24240 SALO
Finland

LEDiL Inc.

228 West Page Street
Suite D
Sycamore IL 60178
USA

Local sales and technical support

[www.ledil.com/
where_to_buy](http://www.ledil.com/where_to_buy)

Shipping locations



Salo, Finland
Hong Kong, China

Distribution Partners

[www.ledil.com/
where_to_buy](http://www.ledil.com/where_to_buy)

Looking for pricing, stock, or lifecycle information?

Click below to explore more details on WIN SOURCE:

-  [View C13055_EMMA-360 on WIN SOURCE](#)
-  [Ledil Information](#)

Optimize Your Supply Chain with WIN SOURCE Solutions

-  Global Sourcing Solution
-  Obsolete Management
-  Cost Control Management
-  Shortage Management
-  Alternative Solution
-  Excess Inventory Management