



THE DATASHEET OF ACST2-8SFP



Overvoltage protected AC switch

Features

- Triac with overvoltage crowbar technology
- High noise immunity: static $dV/dt > 500 \text{ V}/\mu\text{s}$
- ACST210-8FP, in the TO-220FPAB package, provides insulation voltage rated at 1500 V rms

Benefits

- Enables equipment to meet IEC 61000-4-5
- High off-state reliability with planar technology
- Needs no external overvoltage protection
- Reduces component count
- Interfaces directly with the micro-controller
- High immunity against fast transients described in IEC 61000-4-4 standards

Applications

- AC on/off static switching in appliances and industrial control systems
- Driving low power highly inductive loads like solenoid, pump, fan, and micro-motor

Description

The ACST2 series belongs to the ACS™/ACST power switch family built with A.S.D.® (application specific discrete) technology. This high performance device is suited to home appliances or industrial systems and drives loads up to 2 A.

This ACST2 switch embeds a Triac structure with a high voltage clamping device to absorb the inductive turn-off energy and withstand line transients such as those described in the IEC 61000-4-5 standards. The component needs a low gate current to be activated ($I_{GT} < 10 \text{ mA}$) and still shows a high electrical noise immunity complying with IEC standards such as IEC 61000-4-4 (fast transient burst test).

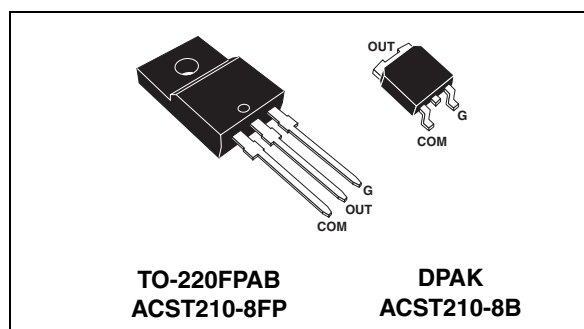

Figure 1. Functional diagram

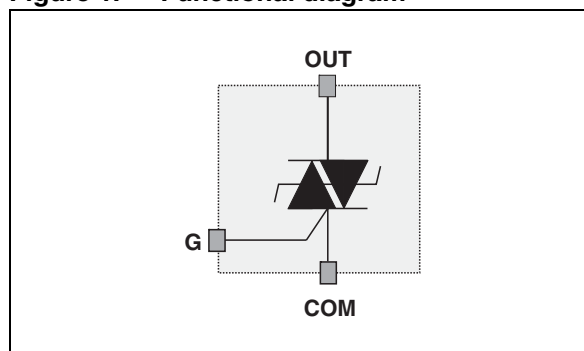

Table 1. Device summary

Symbol	Value	Unit
$I_{T(RMS)}$	2	A
V_{DRM}/V_{RRM}	800	V
I_{GT}	10	mA

TM: ACS is a trademark of STMicroelectronics
 ®: A.S.D. is a registered trademark of STMicroelectronics

1 Characteristics

Table 2. Absolute maximum ratings (limiting values)

Symbol	Parameter		Value	Unit	
$I_{T(RMS)}$	On-state rms current (full sine wave)	TO-220FPAB	$T_c = 105\text{ °C}$	2	A
		DPAK	$T_c = 110\text{ °C}$		
I_{TSM}	Non repetitive surge peak on-state current (full cycle sine wave, T_j initial = 25 °C)	F = 60 Hz	t = 16.7 ms	8.4	A
		F = 50 Hz	t = 20 ms	8.0	
I^2t	I^2t Value for fusing	$t_p = 10\text{ ms}$		0.5	A^2s
dI/dt	Critical rate of rise of on-state current $I_G = 2 \times I_{GT}$, $t_r = 100\text{ ns}$	F = 120 Hz	$T_j = 125\text{ °C}$	50	A/ μs
$V_{PP}^{(1)}$	Non repetitive line peak mains voltage ⁽¹⁾		$T_j = 25\text{ °C}$	2	kV
$P_{G(AV)}$	Average gate power dissipation		$T_j = 125\text{ °C}$	0.1	W
P_{GM}	Peak gate power dissipation ($t_p = 20\text{ }\mu s$)		$T_j = 125\text{ °C}$	10	W
I_{GM}	Peak gate current ($t_p = 20\text{ }\mu s$)		$T_j = 125\text{ °C}$	1.6	A
T_{stg} T_j	Storage junction temperature range Operating junction temperature range			-40 to +150 -40 to +125	$^{\circ}C$
T_l	Maximum lead soldering temperature during 10 s (at 3 mm from plastic case)			260	$^{\circ}C$
$V_{INS(RMS)}$	Insulation rms voltage		TO-220FPAB	1500	V

1. According to test described in IEC 61000-4-5 standard and [Figure 18](#)

Table 3. Electrical characteristics ($T_j = 25\text{ °C}$, unless otherwise specified)

Symbol	Test conditions	Quadrant		Value	Unit
$I_{GT}^{(1)}$	$V_{OUT} = 12\text{ V}$, $R_L = 33\text{ }\Omega$	I - II - III	MAX	10	mA
V_{GT}	$V_{OUT} = 12\text{ V}$, $R_L = 33\text{ }\Omega$	I - II - III	MAX	1.1	V
V_{GD}	$V_{OUT} = V_{DRM}$, $R_L = 3.3\text{ k}\Omega$, $T_j = 125\text{ °C}$	I - II - III	MIN	0.2	V
$I_H^{(2)}$	$I_{OUT} = 100\text{ mA}$		MAX	10	mA
I_L	$I_G = 1.2 \times I_{GT}$	I - III	MAX	25	mA
		II	MAX	35	
dV/dt ⁽²⁾	$V_{OUT} = 67\% V_{DRM}$ gate open, $T_j = 125\text{ °C}$		MIN	500	V/ μs
(dI/dt) _c ⁽²⁾	(dV/dt) _c = $15\text{ V}/\mu s$, $T_j = 125\text{ °C}$		MIN	0.5	A/ms
V_{CL}	$I_{CL} = 0.1\text{ mA}$, $t_p = 1\text{ ms}$, $T_j = 25\text{ °C}$		MIN	850	V

1. Minimum I_{GT} is guaranteed at 5% of I_{GT} max

2. For both polarities of OUT pin referenced to COM pin

Table 4. Static electrical characteristics

Symbol	Test conditions			Value	Unit
$V_{TM}^{(1)}$	$I_{TM} = 2.8 \text{ A}$, $t_p = 500 \mu\text{s}$	$T_j = 25 \text{ }^\circ\text{C}$	MAX	2	V
$V_{TO}^{(1)}$	Threshold voltage	$T_j = 125 \text{ }^\circ\text{C}$	MAX	0.9	V
$R_D^{(1)}$	Dynamic resistance	$T_j = 125 \text{ }^\circ\text{C}$	MAX	250	mΩ
I_{DRM} I_{RRM}	$V_{OUT} = V_{DRM} / V_{RRM}$	$T_j = 25 \text{ }^\circ\text{C}$	MAX	10	μA
		$T_j = 125 \text{ }^\circ\text{C}$		0.5	mA

1. For both polarities of OUT pin referenced to COM pin

Table 5. Thermal resistances

Symbol	Parameter		Value	Unit
$R_{th(j-c)}$	Junction to case (AC)	DPAK	4.5	°C/W
		TO-220FPAB	7	
$R_{th(j-a)}$	Junction to ambient	TO-220FPAB	60	
		$S_{CU}^{(1)} = 0.5 \text{ cm}^2$ DPAK	70	

1. S_{CU} = copper surface under tab

Figure 2. Maximum power dissipation versus on-state rms current (full cycle)

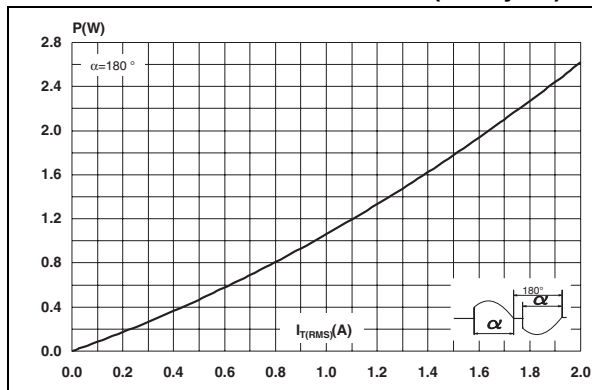

Figure 3. On-state rms current versus case temperature

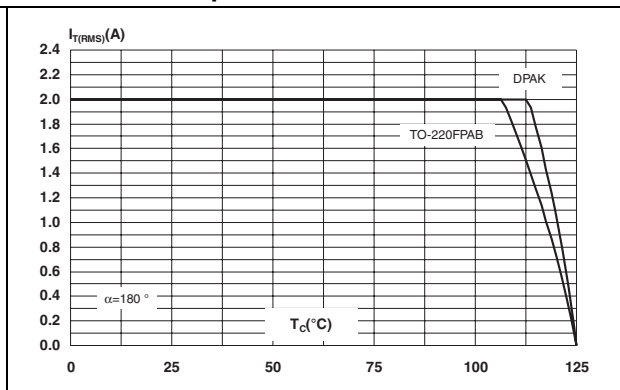

Figure 4. On-state rms current versus ambient temperature

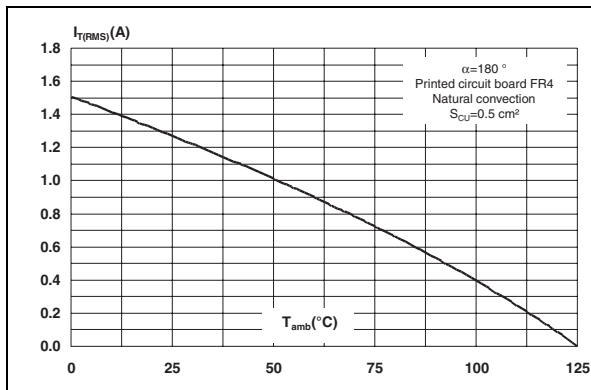

Figure 5. Relative variation of thermal impedance versus pulse duration TO-220FPAB

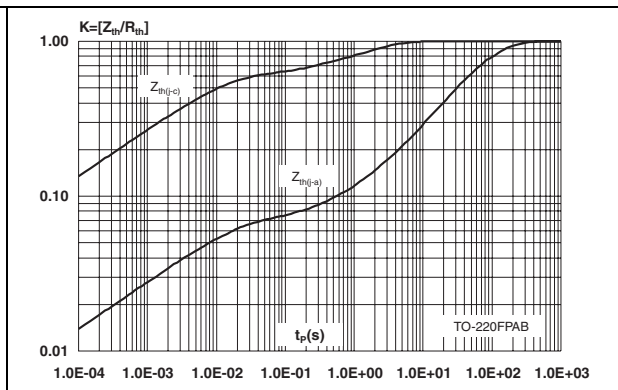

Figure 6. Relative variation of thermal impedance versus pulse duration DPAK

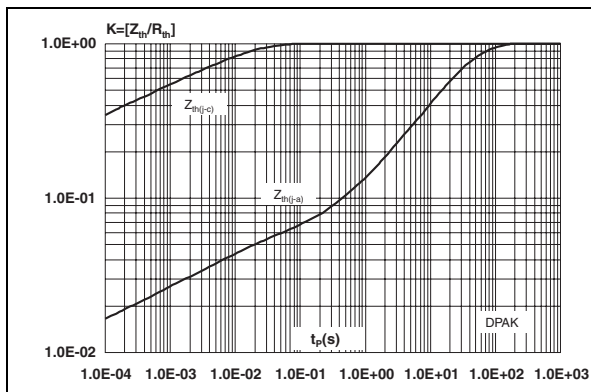

Figure 7. Relative variation of gate trigger, holding and latching current versus junction temperature

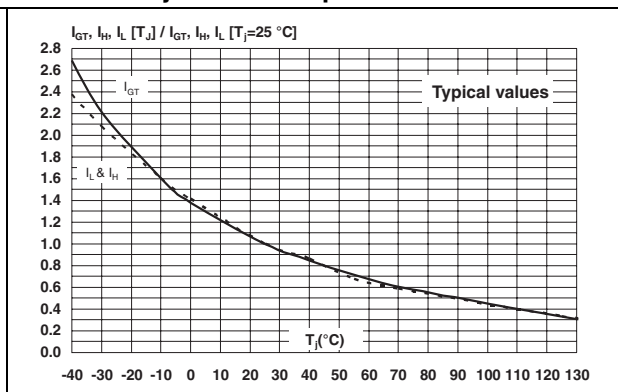

Figure 8. Relative variation of static dV/dt versus junction temperature

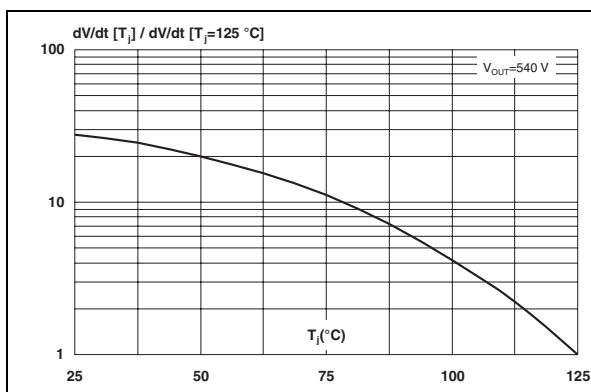

Figure 9. Relative variation of critical rate of decrease of main current versus reapplied dV/dt (typical values)

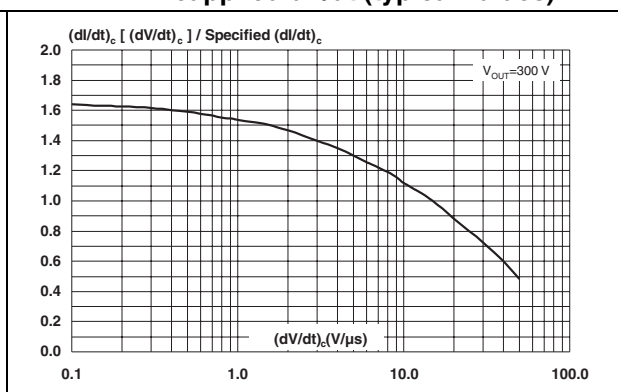

Figure 10. Relative variation of critical rate of decrease of main current versus junction temperature

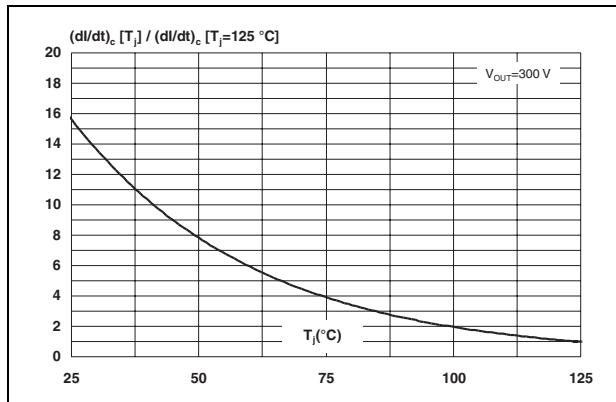

Figure 11. Surge peak on-state current versus number of cycles

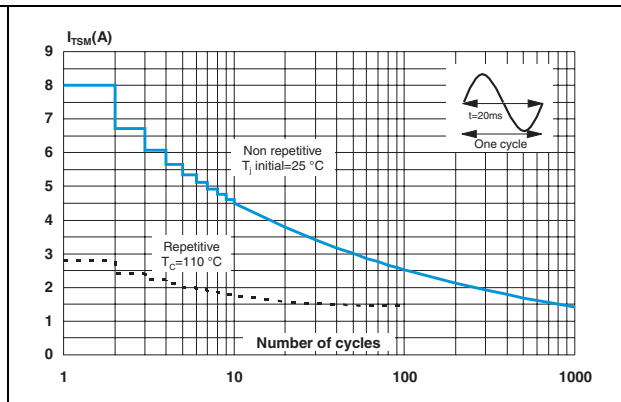

Figure 12. Non repetitive surge peak on-state current and corresponding value of I^2t

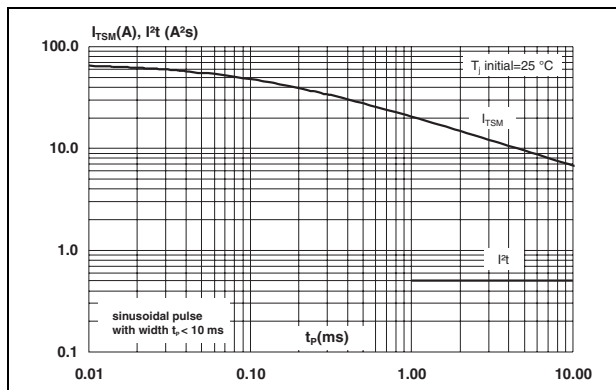

Figure 13. On-state characteristics (maximum values)

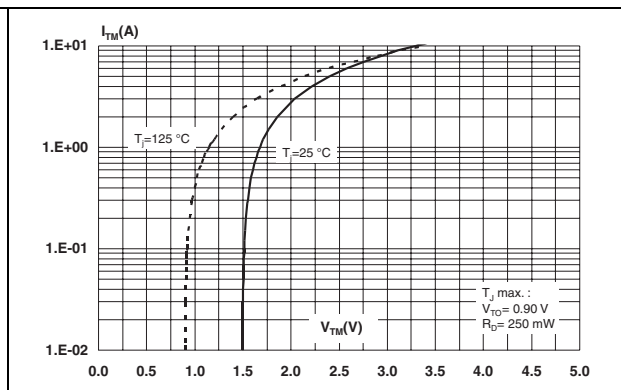

Figure 14. Thermal resistance junction to ambient versus copper surface under tab DPAK

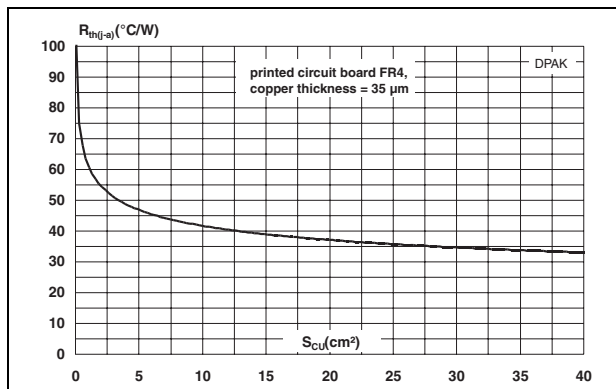
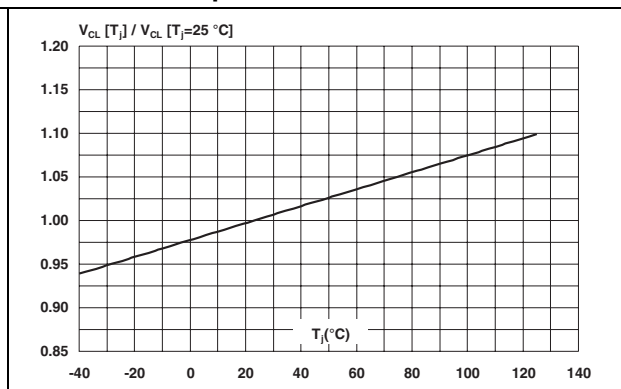

Figure 15. Relative variation of clamping voltage V_{CL} versus junction temperature



2 Application information

2.1 Typical application description

The ACST2 device has been designed to switch on and off highly inductive or resistive loads such as pump, valve, fan, or bulb lamp. Thanks to its high sensitivity ($I_{GT} \text{ max} = 10 \text{ mA}$), the ACST2 can be driven directly by logic level circuits through a resistor as shown on the typical application diagram. Thanks to its thermal and turn-off commutation performances, the ACST2 switch can drive, without any additional snubber, an inductive load up to 2 A.

Figure 16. AC induction motor control – typical diagram

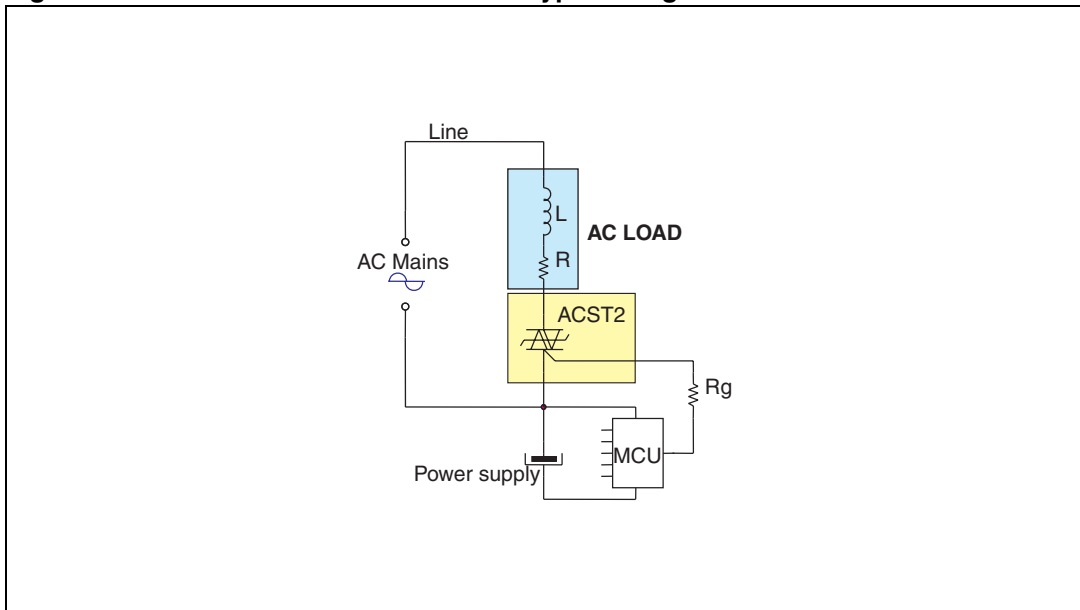

2.2 AC line transient voltage ruggedness

In comparison with standard Triacs, which are not robust against surge voltage, the ACST2 is self-protected against over-voltage, specified by the new parameter V_{CL} . In addition, the ACST2 is a sensitive device ($I_{GT} = 10 \text{ ma}$), but provides a high noise immunity level against fast transients. The ACST2 switch can safely withstand AC line transient voltages either by clamping the low energy spikes, such as inductive spikes at switch off, or by switching to the on state (for less than 10 ms) to dissipate higher energy shocks through the load. This safety feature works even with high turn-on current ramp up.

The test circuit of [Figure 17](#) represents the ACST2 application, and is used to stress the ACST switch according to the IEC 61000-4-5 standard conditions. With the additional effect of the load which is limiting the current, the ACST switch withstands the voltage spikes up to 2 kV on top of the peak line voltage. The protection is based on an overvoltage crowbar technology. The ACST2 folds back safely to the on state as shown in [Figure 18](#). The ACST2 recovers its blocking voltage capability after the surge and the next zero current crossing. Such a non repetitive test can be done at least 10 times on each AC line voltage polarity.

Figure 17. Overvoltage ruggedness test circuit for resistive and inductive loads for IEC 61000-4-5 standards

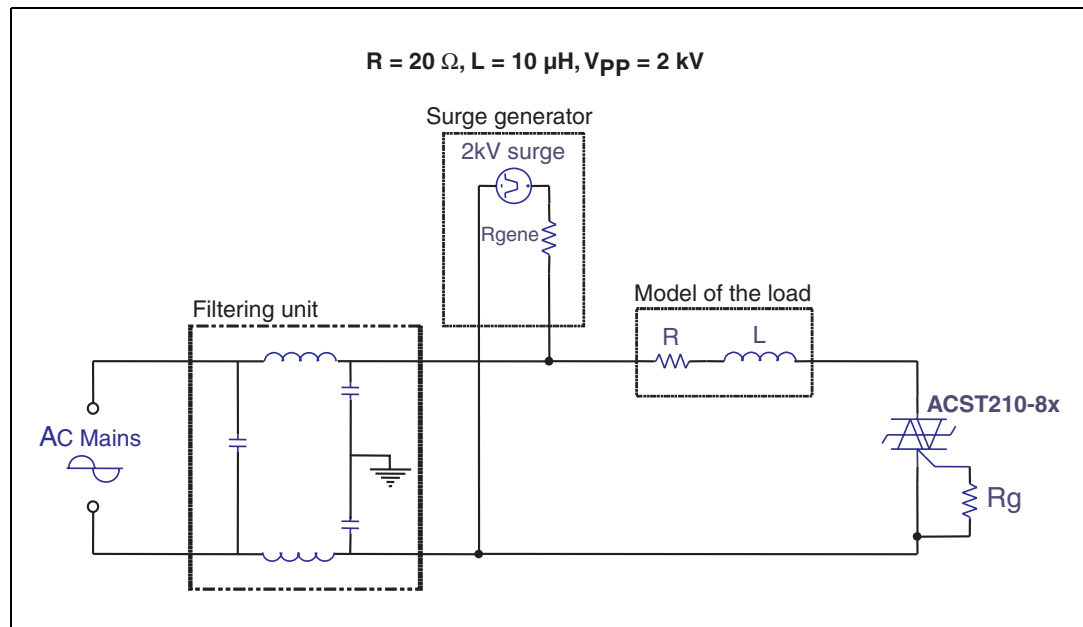
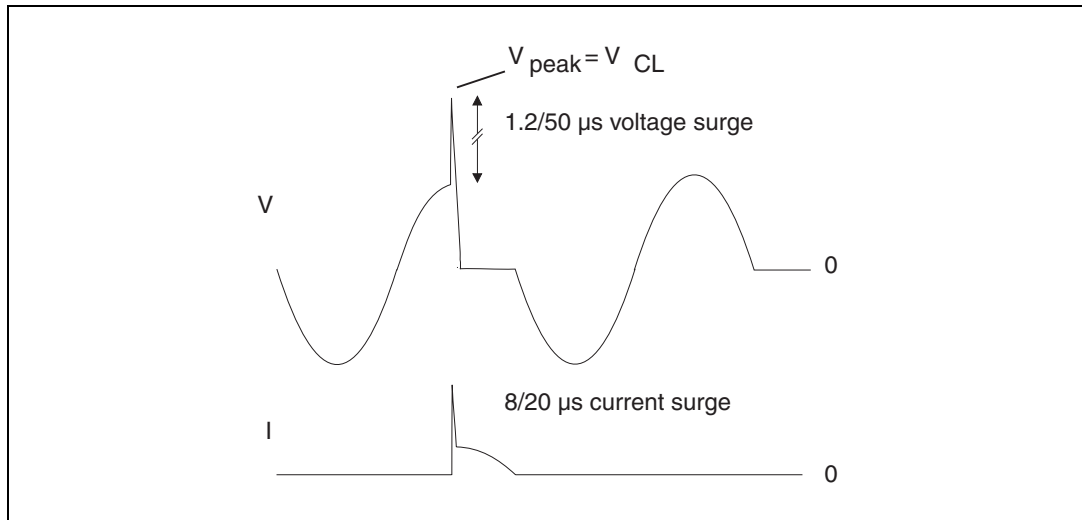

Figure 18. Typical current and voltage waveforms across the ACST2 during IEC 61000-4-5 standard test



2.3 Electrical noise immunity

The ACST2 is a sensitive device ($I_{GT} = 10 \text{ mA}$) and can be controlled directly through a simple resistor by a logic level circuit, and still provides a high electrical noise immunity. The intrinsic immunity of the ACST2 is shown by the specified dV/dt equal to $500 \text{ V}/\mu\text{s}$ @ $125 \text{ }^\circ\text{C}$. This immunity level is 5 to 10 times higher than the immunity provided by an equivalent standard technology Triac with the same sensitivity. In other words, the ACST2 is sensitive, but has an immunity usually available only for non-sensitive device (I_{GT} higher than 35 mA).

3 Ordering information scheme

Figure 19. Ordering information scheme

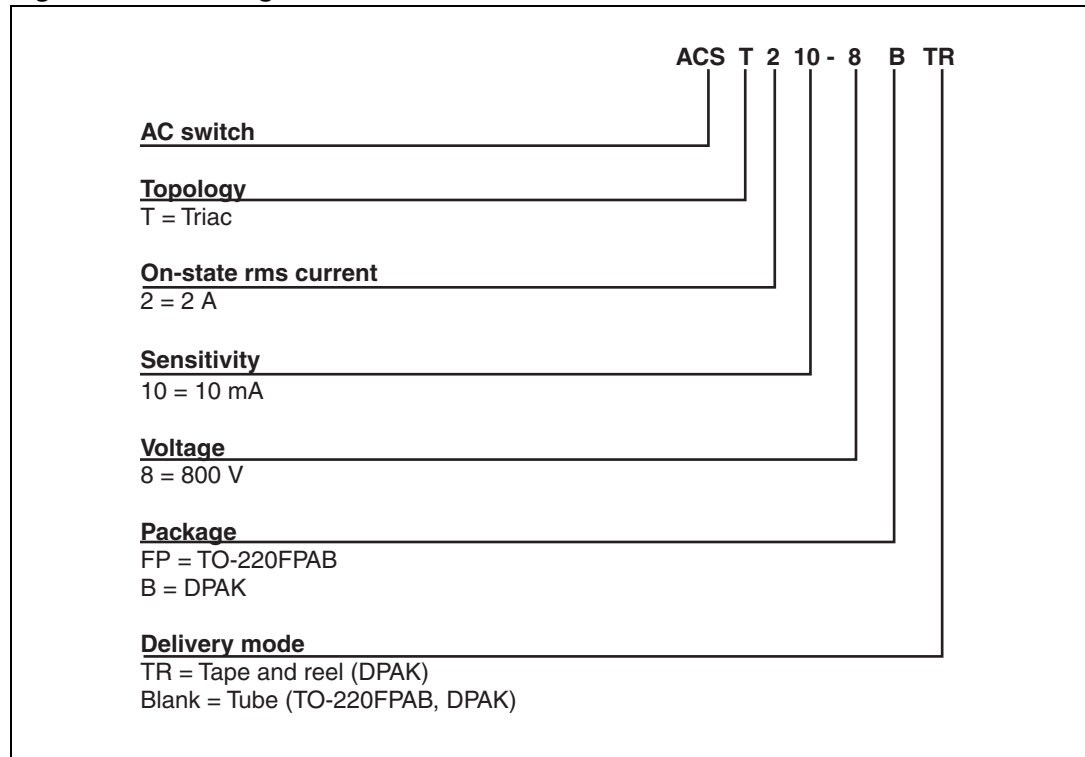

4 Package information

- Epoxy meets UL94, V0
- Recommended torque (TO-220FPAB): 0.4 to 0.6 N·m

In order to meet environmental requirements, ST offers these devices in different grades of ECOPACK® packages, depending on their level of environmental compliance. ECOPACK® specifications, grade definitions and product status are available at: www.st.com. ECOPACK® is an ST trademark.

Table 6. TO-220FPAB dimensions

Ref.	Dimensions			
	Millimeters		Inches	
	Min.	Max.	Min.	Max.
A	4.4	4.6	0.173	0.181
B	2.5	2.7	0.098	0.106
D	2.5	2.75	0.098	0.108
E	0.45	0.70	0.018	0.027
F	0.75	1	0.030	0.039
F1	1.15	1.70	0.045	0.067
F2	1.15	1.70	0.045	0.067
G	4.95	5.20	0.195	0.205
G1	2.4	2.7	0.094	0.106
H	10	10.4	0.393	0.409
L2	16 Typ.		0.63 Typ.	
L3	28.6	30.6	1.126	1.205
L4	9.8	10.6	0.386	0.417
L5	2.9	3.6	0.114	0.142
L6	15.9	16.4	0.626	0.646
L7	9.00	9.30	0.354	0.366
Dia.	3.00	3.20	0.118	0.126

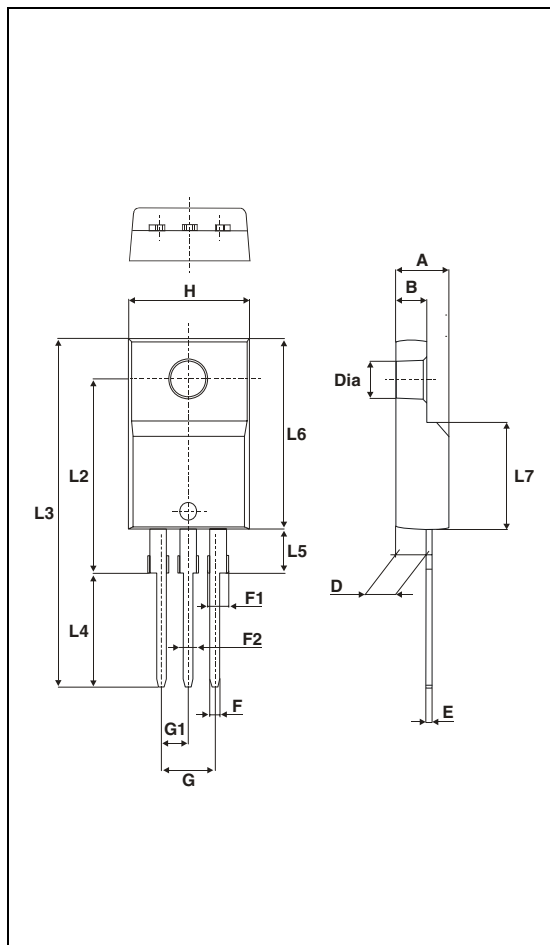
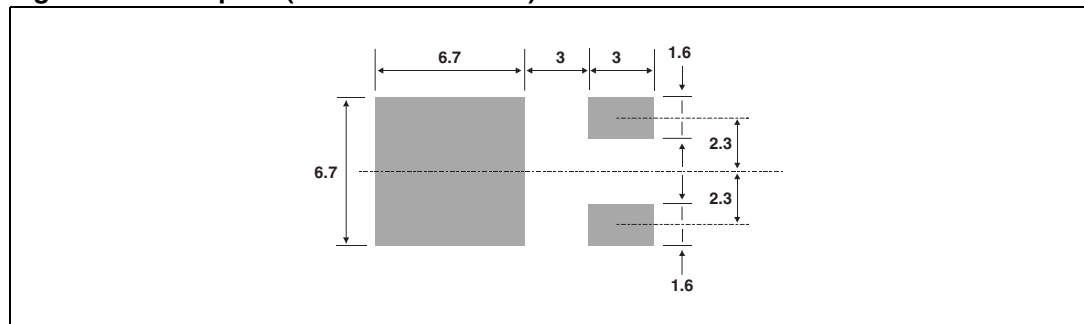

Table 7. DPAK dimensions

Ref.	Dimensions			
	Millimeters		Inches	
	Min.	Max.	Min.	Max.
A	2.20	2.40	0.086	0.094
A1	0.90	1.10	0.035	0.043
A2	0.03	0.23	0.001	0.009
B	0.64	0.90	0.025	0.035
B2	5.20	5.40	0.204	0.212
C	0.45	0.60	0.017	0.023
C2	0.48	0.60	0.018	0.023
D	6.00	6.20	0.236	0.244
E	6.40	6.60	0.251	0.259
G	4.40	4.60	0.173	0.181
H	9.35	10.10	0.368	0.397
L2	0.80 typ.		0.031 typ.	
L4	0.60	1.00	0.023	0.039
V2	0°	8°	0°	8°

Figure 20. Footprint (dimensions in mm)



5 Ordering information

Table 8. Ordering information

Order code	Marking	Package	Weight	Base Qty	Packing mode
ACST210-8FP	ACST2108	TO-220FPAB	2.4g	50	Tube
ACST210-8B		DPAK	0.3g	50	Tube
ACST210-8B-TR		DPAK	0.3g	2500	Tape and Reel

6 Revision history

Table 9. Document revision history

Date	Revision	Changes
01-Mar-2007	1	Initial release.
13-Apr-2010	2	Updated ECOPACK statement. Reformatted for consistency with other datasheets in this product class.
01-Jul-2010	3	Updated Figure 19 .

Please Read Carefully:

Information in this document is provided solely in connection with ST products. STMicroelectronics NV and its subsidiaries ("ST") reserve the right to make changes, corrections, modifications or improvements, to this document, and the products and services described herein at any time, without notice.

All ST products are sold pursuant to ST's terms and conditions of sale.

Purchasers are solely responsible for the choice, selection and use of the ST products and services described herein, and ST assumes no liability whatsoever relating to the choice, selection or use of the ST products and services described herein.

No license, express or implied, by estoppel or otherwise, to any intellectual property rights is granted under this document. If any part of this document refers to any third party products or services it shall not be deemed a license grant by ST for the use of such third party products or services, or any intellectual property contained therein or considered as a warranty covering the use in any manner whatsoever of such third party products or services or any intellectual property contained therein.

UNLESS OTHERWISE SET FORTH IN ST'S TERMS AND CONDITIONS OF SALE ST DISCLAIMS ANY EXPRESS OR IMPLIED WARRANTY WITH RESPECT TO THE USE AND/OR SALE OF ST PRODUCTS INCLUDING WITHOUT LIMITATION IMPLIED WARRANTIES OF MERCHANTABILITY, FITNESS FOR A PARTICULAR PURPOSE (AND THEIR EQUIVALENTS UNDER THE LAWS OF ANY JURISDICTION), OR INFRINGEMENT OF ANY PATENT, COPYRIGHT OR OTHER INTELLECTUAL PROPERTY RIGHT.

UNLESS EXPRESSLY APPROVED IN WRITING BY AN AUTHORIZED ST REPRESENTATIVE, ST PRODUCTS ARE NOT RECOMMENDED, AUTHORIZED OR WARRANTED FOR USE IN MILITARY, AIR CRAFT, SPACE, LIFE SAVING, OR LIFE SUSTAINING APPLICATIONS, NOR IN PRODUCTS OR SYSTEMS WHERE FAILURE OR MALFUNCTION MAY RESULT IN PERSONAL INJURY, DEATH, OR SEVERE PROPERTY OR ENVIRONMENTAL DAMAGE. ST PRODUCTS WHICH ARE NOT SPECIFIED AS "AUTOMOTIVE GRADE" MAY ONLY BE USED IN AUTOMOTIVE APPLICATIONS AT USER'S OWN RISK.

Resale of ST products with provisions different from the statements and/or technical features set forth in this document shall immediately void any warranty granted by ST for the ST product or service described herein and shall not create or extend in any manner whatsoever, any liability of ST.

ST and the ST logo are trademarks or registered trademarks of ST in various countries.

Information in this document supersedes and replaces all information previously supplied.

The ST logo is a registered trademark of STMicroelectronics. All other names are the property of their respective owners.

© 2010 STMicroelectronics - All rights reserved



STMicroelectronics group of companies

Australia - Belgium - Brazil - Canada - China - Czech Republic - Finland - France - Germany - Hong Kong - India - Israel - Italy - Japan - Malaysia - Malta - Morocco - Philippines - Singapore - Spain - Sweden - Switzerland - United Kingdom - United States of America

www.st.com

Looking for pricing, stock, or lifecycle information?

Click below to explore more details on WIN SOURCE:

-  [View ACST2-8SFP on WIN SOURCE](#)
-  [STMicroelectronics Information](#)

Optimize Your Supply Chain with WIN SOURCE Solutions

-  Global Sourcing Solution
-  Obsolete Management
-  Cost Control Management
-  Shortage Management
-  Alternative Solution
-  Excess Inventory Management