



**THE DATASHEET OF
CGRM4005-G**



CGRM4004-G Thru. CGRM4007-G

Reverse Voltage: 400 to 1000 Volts

Forward Current: 1.0 Amp

RoHS Device

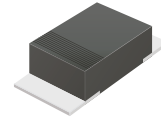

Features

- Excellent power dissipation offers better reverse leakage current and thermal resistance.
- Low profile surface mounted application in order to optimize board space.
- Tiny plastic SMD package.
- High current capability.
- High surge current capability.
- Glass passivated chip junction.
- Lead-free parts meet RoHS requirements.

Mechanical data

- Epoxy: UL94V-0 rated flame retardant.
- Case: Molded plastic, SOD-123H/MINI SMA
- Terminals: Solderable per MIL-STD-750, Method 2026.
- Polarity: Indicated by cathode band.
- Mounting Position: any
- Weight: 0.018grams approx.

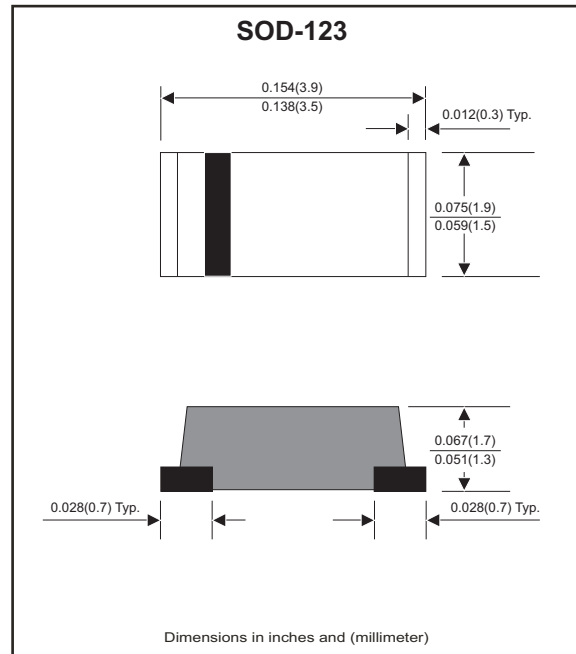

Circuit diagram



Maximum Ratings and Electrical Characteristics (at $T_A=25^\circ\text{C}$ unless otherwise noted)

Parameter	Symbol	CGRM 4004-G	CGRM 4005-G	CGRM 4007-G	Unit
Max. repetitive peak reverse voltage	V_{RRM}	400	600	1000	V
Max. DC blocking voltage	V_{DC}	400	600	1000	V
Max. RMS voltage	V_{RMS}	280	420	700	V
Max. averaged forward current	I_O	1.0			A
Max. Instantaneous forward voltage at $I_F=1.0A$	V_F	1.1	1.0	1.1	V
Max. Forward surge current, 8.3ms single half sine-wave superimposed on rated load (JEDEC method)	I_{FSM}	30			A
Reverse current at rated @ $T_A=25^\circ\text{C}$ DC blocking voltage @ $T_A=125^\circ\text{C}$	I_R		5 50		μA
Typ. Thermal resistance, junction to ambient air	$R_{\theta JA}$		60		$^\circ\text{C/W}$
Typ. Junction capacitance $f=1\text{MHz}$ and applied 4V DC reverse voltage	C_J		15		pF
Operating junction temperature	T_J		-55 to +150		$^\circ\text{C}$
Storage temperature range	T_{STG}		-65 to +175		$^\circ\text{C}$

Rating and Characteristic Curves (CGRM4004-G Thru. CGRM4007-G)

Fig.1- Reverse Characteristics

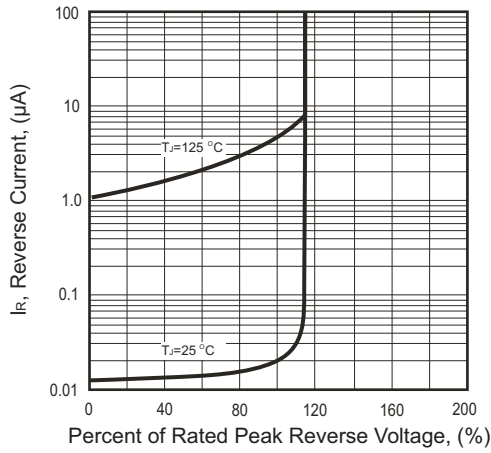

Fig.2- Forward Characteristics

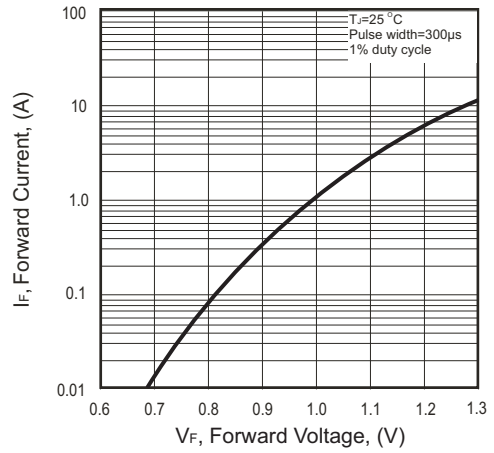

Fig.3 Junction Capacitance

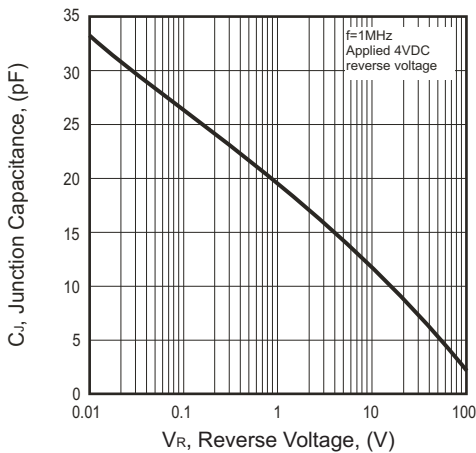

Fig.4 Current Derating Curve

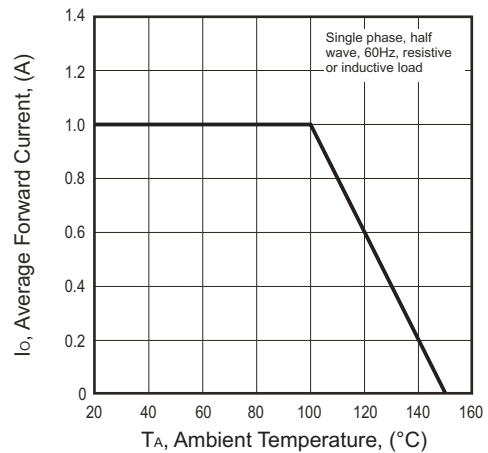
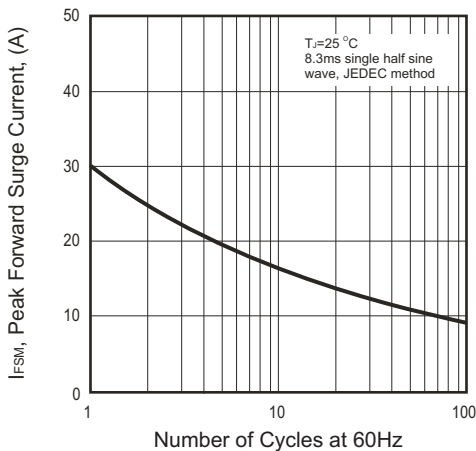
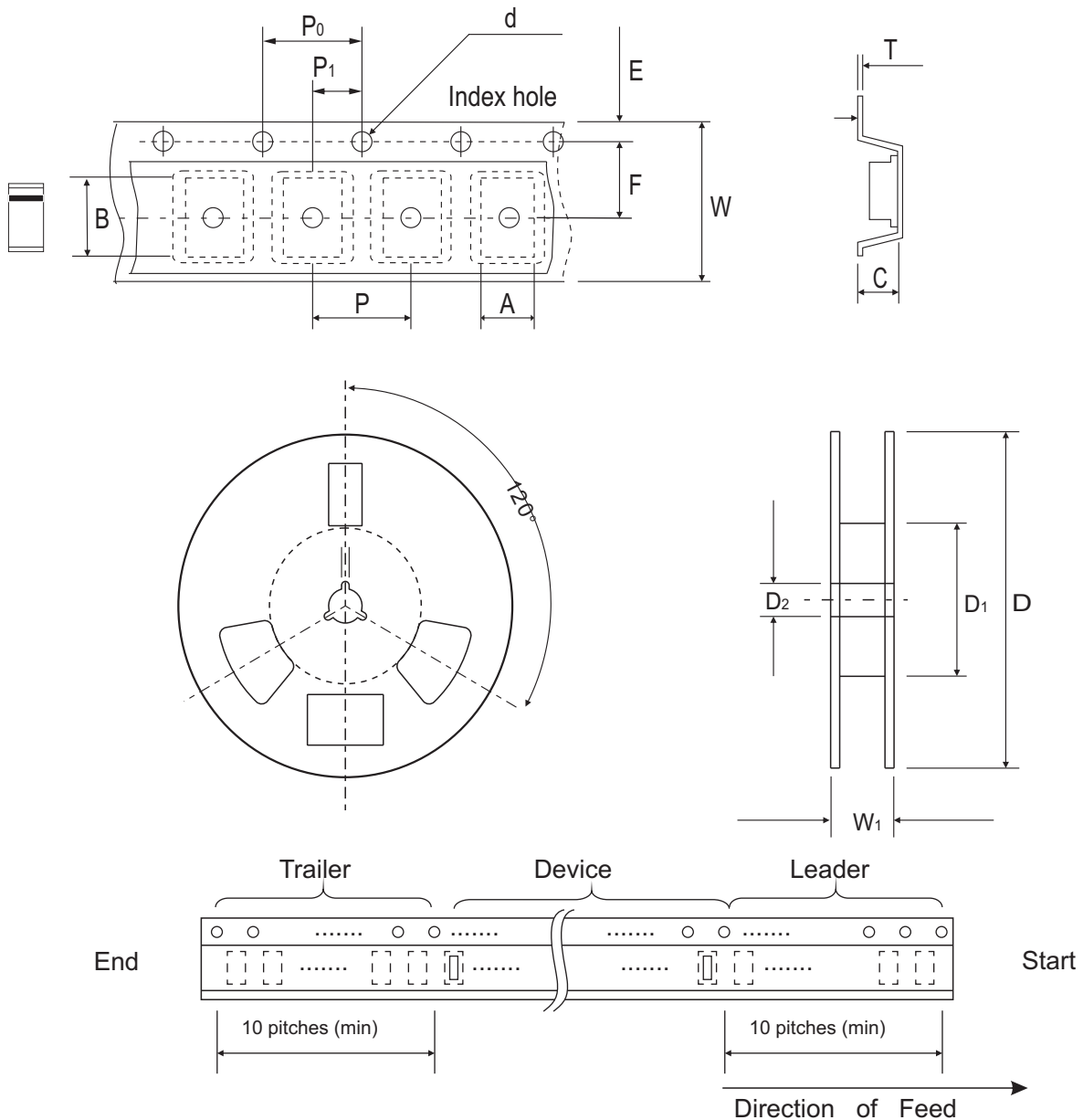

Fig.5 Non-repetitive Forward Surge Current



Reel Taping Specification (7" Reel)



Mini-SMA/SOD-123	SYMBOL	A	B	C	d	D	D1	D2
	(mm)	1.90 ± 0.10	3.90 ± 0.10	1.68 ± 0.10	1.50 ± 0.10	178 ± 2.00	62.0 MIN.	13.0 ± 0.50
	(inch)	0.075 ± 0.04	0.153 ± 0.04	0.066 ± 0.04	0.059 ± 0.004	7.00 ± 0.079	2.440 MIN.	0.512 ± 0.020

Mini-SMA/SOD-123	SYMBOL	E	F	P	P0	P1	T	W	W1
	(mm)	1.75 ± 0.10	3.50 ± 0.10	4.00 ± 0.10	4.00 ± 0.10	2.00 ± 0.10	0.23 ± 0.10	8.00 ± 0.30	11.4 ± 0.10
	(inch)	0.069 ± 0.004	0.138 ± 0.004	0.157 ± 0.004	0.157 ± 0.004	0.079 ± 0.004	0.009 ± 0.004	0.315 ± 0.012	0.449 ± 0.004

Reel Taping Specification (13" Reel)

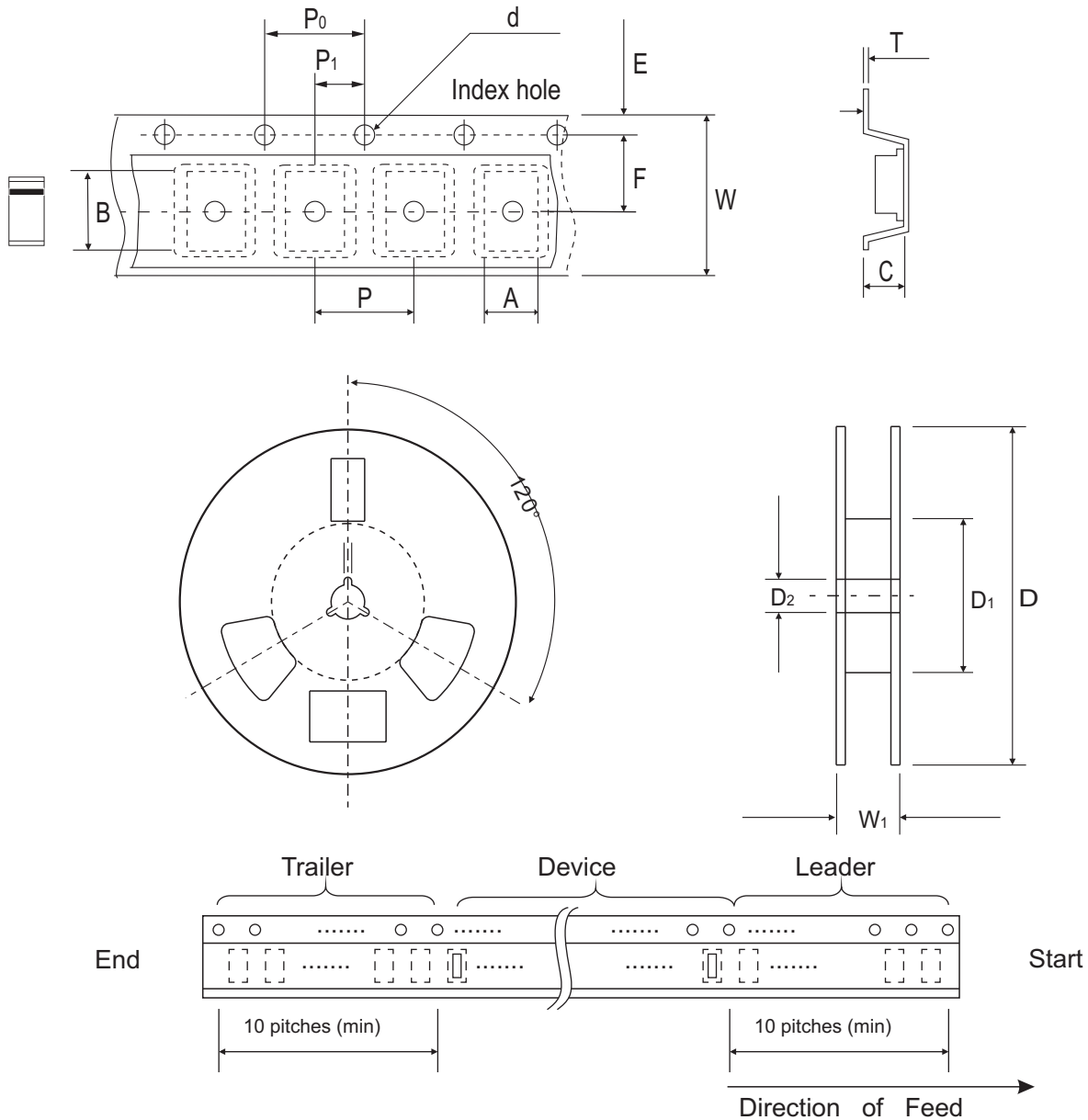

Mini-SMA/SOD-123	SYMBOL	A	B	C	d	D	D1	D2
	(mm)	1.90 ± 0.10	3.90 ± 0.10	1.68 ± 0.10	1.50 ± 0.10	330 ± 2.00	100.0 MIN.	13.0 ± 0.50
	(inch)	0.075 ± 0.04	0.153 ± 0.04	0.066 ± 0.04	0.059 ± 0.004	12.99 ± 0.079	3.937 MIN.	0.512 ± 0.020

Mini-SMA/SOD-123	SYMBOL	E	F	P	P0	P1	T	W	W1
	(mm)	1.75 ± 0.10	3.50 ± 0.10	4.00 ± 0.10	4.00 ± 0.10	2.00 ± 0.10	0.23 ± 0.10	8.00 ± 0.30	11.4 ± 1.00
	(inch)	0.069 ± 0.004	0.138 ± 0.004	0.157 ± 0.004	0.157 ± 0.004	0.079 ± 0.004	0.009 ± 0.004	0.315 ± 0.012	0.449 ± 0.039

Marking Code

Part Number	Marking Code
CGRM4004-G	A4
CGRM4005-G	A5
CGRM4007-G	A7

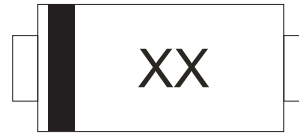

xx = Product type marking code

Suggested PAD Layout

SIZE	Mini-SMA/SOD-123	
	(mm)	(inch)
A	3.30	0.130
B	1.40	0.055
C	1.90	0.075
D	4.70	0.185
E	1.90	0.075

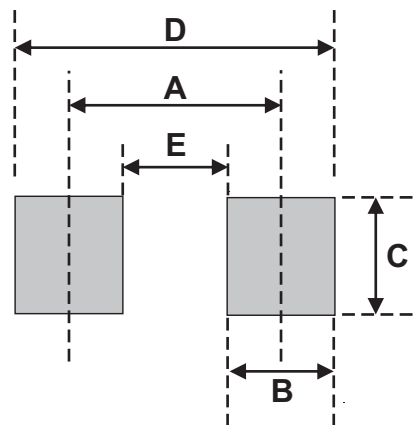

Standard Packaging

Case Type	Qty Per Reel	Reel Size
	(Pcs)	(inch)
Mini-SMA/SOD-123	2,500	7
	10,000	13

Looking for pricing, stock, or lifecycle information?

Click below to explore more details on WIN SOURCE:

- [View CGRM4005-G on WIN SOURCE](#)
- [Comchip Technology Information](#)

Optimize Your Supply Chain with WIN SOURCE Solutions

- ✓ Global Sourcing Solution
- ✓ Obsolete Management
- ✓ Cost Control Management
- ✓ Shortage Management
- ✓ Alternative Solution
- ✓ Excess Inventory Management