



THE DATASHEET OF SLVE2.8.TCT



PROTECTION PRODUCTS

Description

The SLV series of transient voltage suppressors are designed to protect low voltage, state-of-the-art CMOS semiconductors from transients caused by electrostatic discharge (ESD), cable discharge events (CDE), lightning and other induced voltage surges.

The devices are constructed using Semtech's proprietary EPD process technology. The EPD process provides low standoff voltages with significant reductions in leakage currents and capacitance over silicon-avalanche diode processes. The SLVE2.8 and SLVG2.8 are in a SOT-143 package and have a low 2.8V working voltage. They may be used to protect one line in differential or common mode. The "flow-thru" design minimizes trace inductance and reduces voltage overshoot associated with ESD events.

The SLV is specifically designed to protect low voltage components such as Ethernet transceivers, laser diodes, ASICs, and high-speed RAM. The low clamping voltage of the SLV minimizes the stress on the protected IC.

The SLV series TVS diodes will exceed the surge requirements of IEC 61000-4-2, Level 4.

Features

- ◆ 300 Watts peak pulse power ($t_p = 8/20\mu s$)
- ◆ Transient protection for low voltage data lines to **IEC 61000-4-2 (ESD) $\pm 15kV$ (air), $\pm 8kV$ (contact)**
IEC 61000-4-4 (EFT) 40A (5/50ns)
IEC 61000-4-5 (Lightning) 24A (8/20 μs)
- ◆ Protects one line
- ◆ Comprehensive pin out for easy board layout
- ◆ Low capacitance
- ◆ Low leakage current
- ◆ Low operating and clamping voltages
- ◆ Solid-state EPD TVS process technology

Mechanical Characteristics

- ◆ JEDEC SOT-143 package
- ◆ Molding compound flammability rating: UL 94V-0
- ◆ Marking : Marking code
- ◆ Packaging : Tape and Reel per EIA 481

Applications

- ◆ ESD and Latch-up Protection
- ◆ Analog Inputs
- ◆ WAN/LAN Equipment
- ◆ Low Voltage ASICs
- ◆ Desktops, Servers, Notebooks and Handhelds
- ◆ Portable Instrumentation
- ◆ Base Stations
- ◆ Laser Diode Protection

Schematic & Pin Configuration

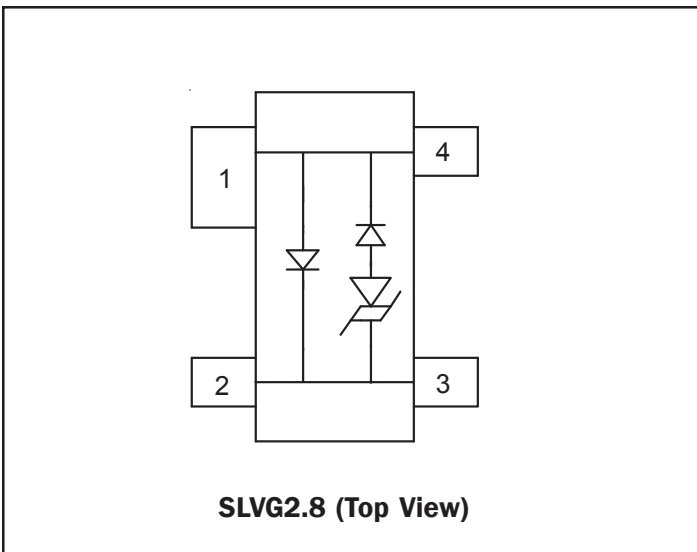

Schematic & PIN Configuration

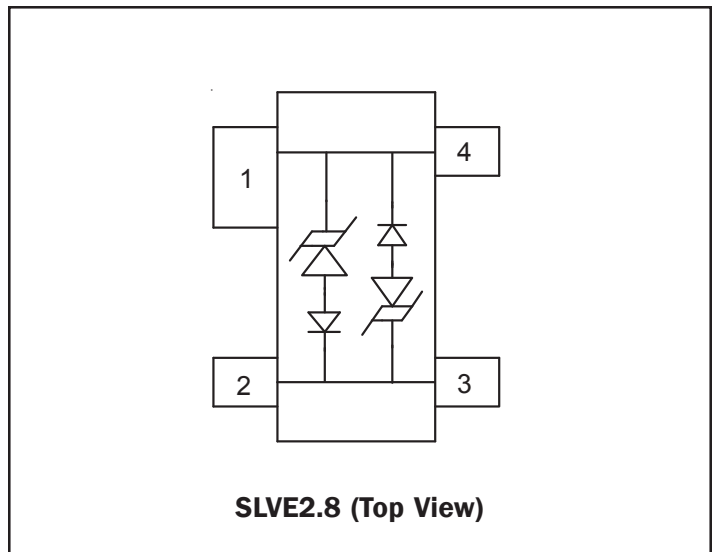

PROTECTION PRODUCTS
Absolute Maximum Rating

Rating	Symbol	Value	Units
Peak Pulse Power ($t_p = 8/20\mu s$)	P_{pk}	300	Watts
Peak Pulse Current ($t_p = 8/20\mu s$)	I_{pp}	24	A
Lead Soldering Temperature	T_L	260 (10 seconds)	°C
Operating Temperature	T_J	-55 to +125	°C
Storage Temperature	T_{STG}	-55 to +150	°C

Electrical Characteristics

SLVE2.8						
Parameter	Symbol	Conditions	Minimum	Typical	Maximum	Units
Reverse Stand-Off Voltage	V_{RWM}				2.8	V
Punch-Through Voltage	V_{PT}	$I_{PT} = 2\mu A$	3.0			V
Snap-Back Voltage	V_{SB}	$I_{SB} = 50mA$	2.8			V
Reverse Leakage Current	I_R	$V_{RWM} = 2.8V, T=25^\circ C$			1	μA
Clamping Voltage	V_C	$I_{pp} = 1A, t_p = 8/20\mu s$			4.1	V
Clamping Voltage	V_C	$I_{pp} = 5A, t_p = 8/20\mu s$			5.3	V
Clamping Voltage	V_C	$I_{pp} = 24A, t_p = 8/20\mu s$			15	V
Junction Capacitance	C_j	Line-to-Line $V_R = 0V, f = 1MHz$			100	pF

SLVG2.8						
Parameter	Symbol	Conditions	Minimum	Typical	Maximum	Units
Reverse Stand-Off Voltage	V_{RWM}				2.8	V
Punch-Through Voltage	V_{PT}	$I_{PT} = 2\mu A$	3.0			V
Snap-Back Voltage	V_{SB}	$I_{SB} = 50mA$	2.8			V
Reverse Leakage Current	I_R	$V_{RWM} = 2.8V, T=25^\circ C$			1	μA
Clamping Voltage	V_C	$I_{pp} = 1A, t_p = 8/20\mu s$			4.1	V
Clamping Voltage	V_C	$I_{pp} = 5A, t_p = 8/20\mu s$			5.3	V
Clamping Voltage	V_C	$I_{pp} = 24A, t_p = 8/20\mu s$			15	V
Junction Capacitance	C_j	Line-to-Line $V_R = 0V, f = 1MHz$			50	pF

PROTECTION PRODUCTS

Typical Characteristics

Non-Repetitive Peak Pulse Power vs. Pulse Time

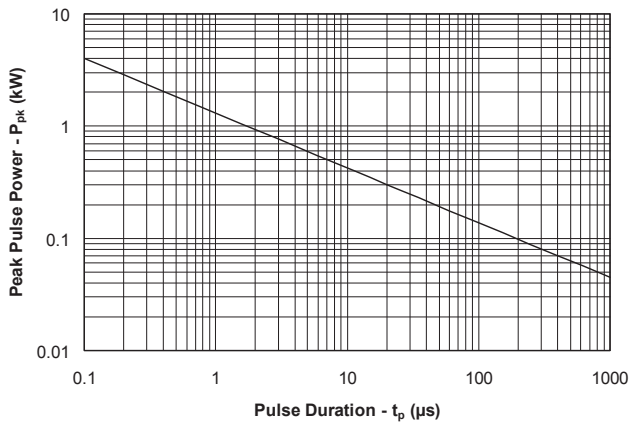

Power Derating Curve

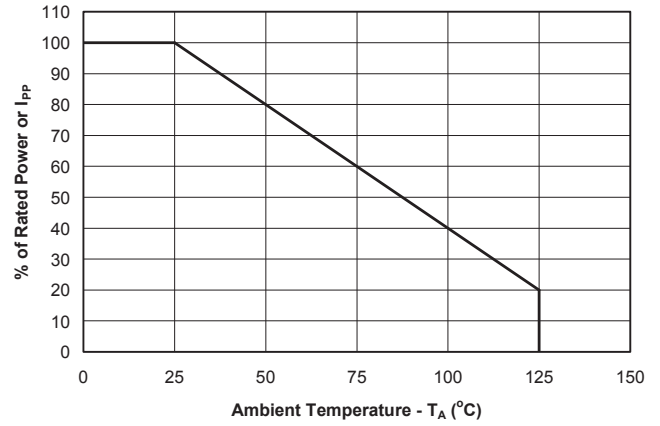

Pulse Waveform

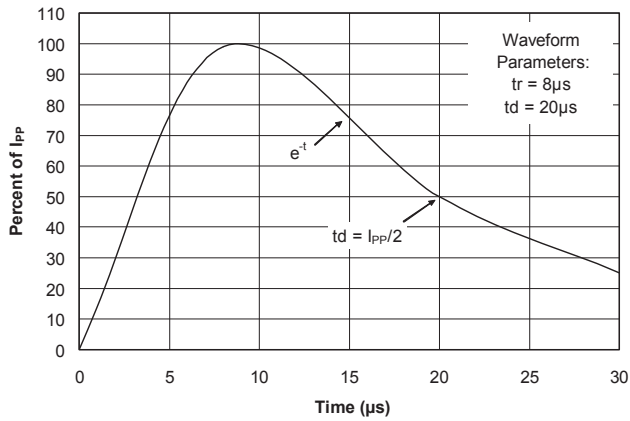

Clamping Voltage vs. Peak Pulse Current

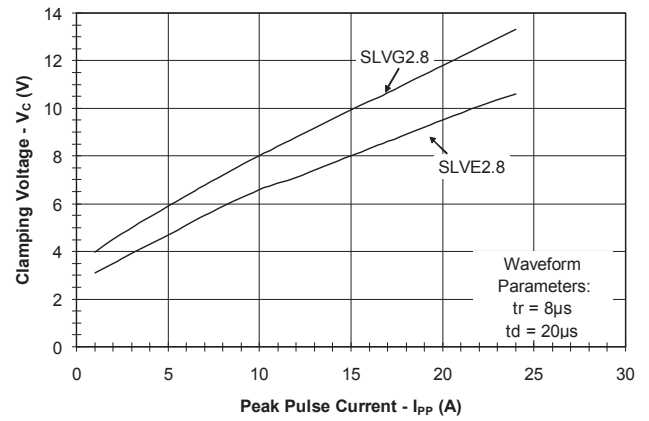

PROTECTION PRODUCTS

Applications Information

Device Connection

Electronic equipment is susceptible to transient disturbances from a variety of sources including: ESD to an open connector or interface, direct or nearby lightning strikes to cables and wires, and charged cables “hot plugged” into I/O ports. The SLV series is designed to protect sensitive components from damage and latch-up which may result from such transient events. The SLVG2.8 is designed to protect one unidirectional line while the SLVE2.8 is designed to protect one bidirectional line (or two differential lines). The options for connecting the devices are as follows:

- **SLVE2.8:** Common mode protection of one bidirectional data line is achieved by connecting the data line input/output at pins 2 and 3. Pins 1 and 4 are connected to ground. For differential protection, pins 1 and 4 can be connected to a second I/O line. For best results, the ground connection should be made directly to a ground plane on the board. The path length should be kept as short as possible to minimize parasitic inductance.
- **SLVG2.8:** Common mode protection of one unidirectional line is achieved by connecting the line to be protected at pins 2 and 3. Pins 1 and 4 are connected to ground. For best results, the ground connection should be made directly to a ground plane on the board. The path length should be kept as short as possible to minimize parasitic inductance.

Circuit Board Layout Recommendations for Suppression of ESD.

Good circuit board layout is critical for the suppression of ESD induced transients. The following guidelines are recommended:

- Place the TVS near the input terminals or connectors to restrict transient coupling.
- Minimize the path length between the TVS and the protected line.
- Minimize all conductive loops including power and ground loops.
- The ESD transient return path to ground should be kept as short as possible.
- Never run critical signals near board edges.
- Use ground planes whenever possible.

Circuit Diagrams

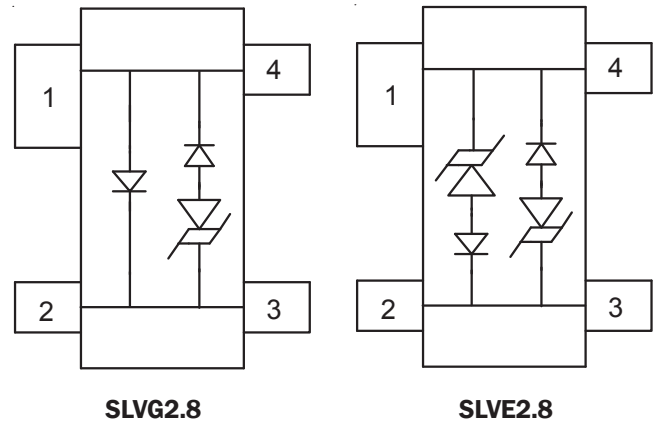

Common Mode Protection (SLVE2.8 and SLVG2.8)

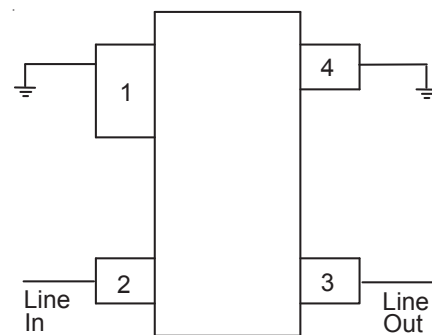

Differential Mode Protection (SLVE2.8 only)

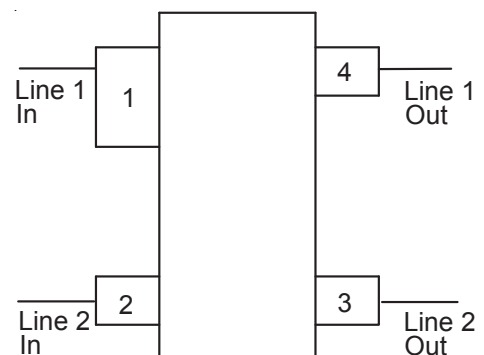

PROTECTION PRODUCTS

Applications Information (continued)

EPD TVS™ Characteristics

The SLV series is constructed using Semtech's proprietary EPD technology. The structure of the EPD TVS is vastly different from the traditional pn-junction devices. At voltages below 5V, high leakage current and junction capacitance render conventional avalanche technology impractical for most applications. However, by utilizing the EPD technology, the SLVE2.8 and SLVG2.8 can effectively operate at 2.8V while maintaining excellent electrical characteristics.

The EPD TVS employs a complex npn structure in contrast to the pn structure normally found in traditional silicon-avalanche TVS diodes. The EPD mechanism is achieved by engineering the center region of the device such that the reverse biased junction does not avalanche, but will "punch-through" to a conducting state. This structure results in a device with superior dc electrical parameters at low voltages while maintaining the capability to absorb high transient currents.

The IV characteristic curve of the EPD device is shown in Figure 1. The device represents a high impedance to the circuit up to the working voltage (V_{RWM}). During a transient event, the device will begin to conduct as it is biased in the reverse direction. When the punch-through voltage (V_{PT}) is exceeded, the device enters a low impedance state, diverting the transient current away from the protected circuit. When the device is conducting current, it will exhibit a slight "snap-back" or negative resistance characteristic due to its structure. This must be considered when connecting the device to a power supply rail. To return to a non-conducting state, the current through the device must fall below the snap-back current (approximately $< 50\text{mA}$).

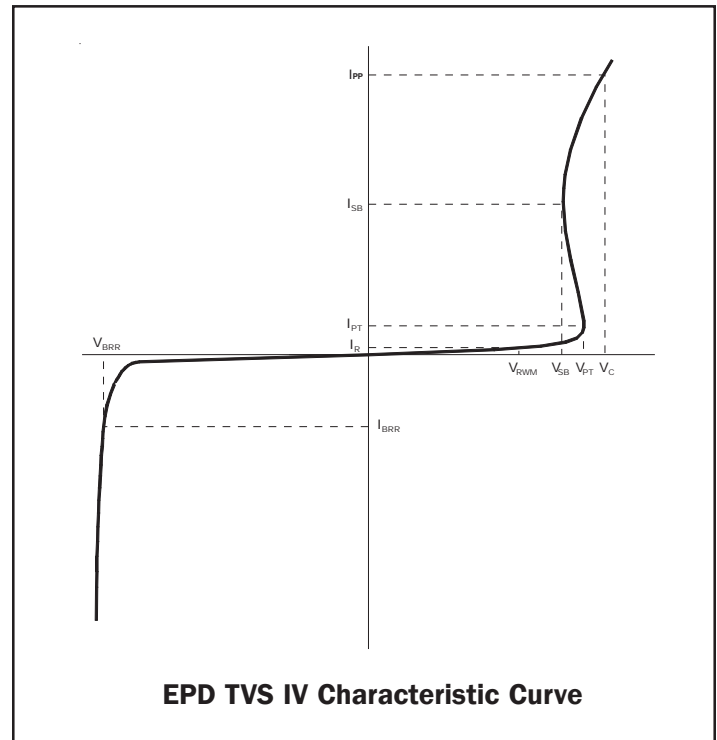

EPD TVS IV Characteristic Curve

PROTECTION PRODUCTS

Outline Drawing - SOT-143

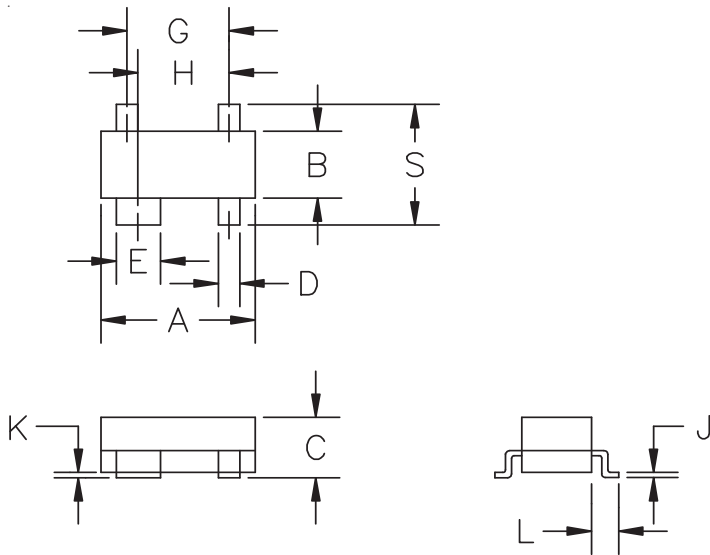

DIM ^N	DIMENSIONS				NOTE
	INCHES		MM		
	MIN	MAX	MIN	MAX	
A	.110	.120	2.80	3.04	—
B	.047	.055	1.20	1.40	—
C	.031	.047	.800	1.20	—
D	.014	.018	.370	.460	—
E	.030	.035	.760	.890	—
G	.076	BSC	1.92	BSC	—
H	.068	BSC	1.72	BSC	—
J	.003	.007	.085	.180	—
K	.001	.004	.013	0.10	—
L	—	.022	—	.55	REF
S	.082	.104	2.10	2.64	—

Notes:

- (1) Controlling dimension: Millimeters.
- (2) Dimension A and B do not include mold protrusions. Mold protrusions are .006" max.

Land Pattern - SOT-143

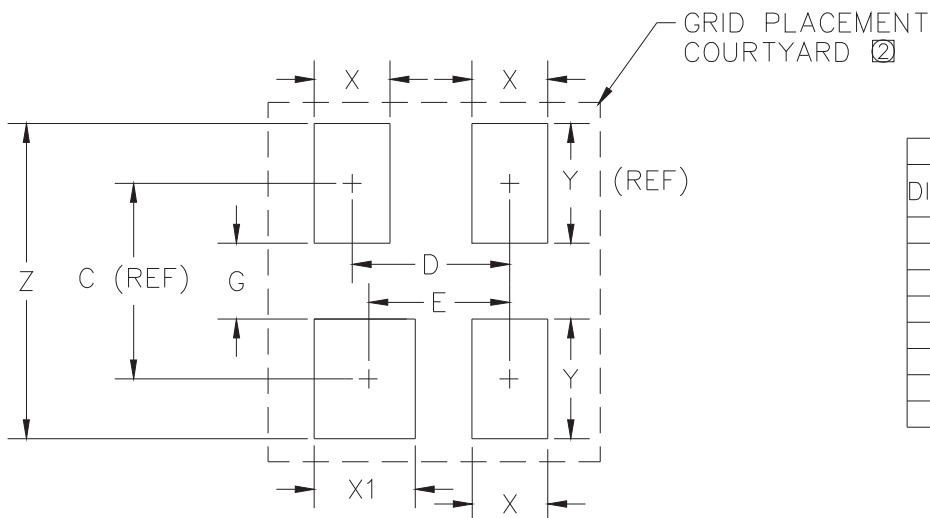

DIM ^N	DIMENSIONS				NOTE
	INCHES		MM		
	MIN	MAX	MIN	MAX	
C	—	.087	—	2.20	—
D	.075	BSC	1.90	BSC	—
E	.067	BSC	1.70	BSC	—
G	.032	.040	.80	1.00	—
X	.032	.040	.80	1.00	—
X1	.040	.048	1.00	1.20	—
Y	—	.055	—	1.40	—
Z	.134	.140	3.40	3.60	—

- ② GRID PLACEMENT COURTYARD IS 8 X 8 ELEMENTS (4mm X 4mm) IN ACCORDANCE WITH THE INTERNATIONAL GRID DETAILED IN IEC PUBLICATION 97.
- ① CONTROLLING DIMENSION: MILLIMETERS.

PROTECTION PRODUCTS**Marking Codes**

Part Number	Marking Code
SLVE2.8	E2.8
SLVG2.8	G2.8

Ordering Information

Part Number	Working Voltage	Qty per Reel	Reel Size
SLVE2.8.TC	2.8V	3,000	7 Inch
SLVG2.8.TC	2.8V	3,000	7 Inch

Note: Consult factory for availability of 13" reels

Contact Information

Semtech Corporation
Protection Products Division
200 Flynn Road, Camarillo, CA 93012
Phone: (805)498-2111 FAX (805)498-3804

Looking for pricing, stock, or lifecycle information?

Click below to explore more details on WIN SOURCE:

-  [View SLVE2.8.TCT on WIN SOURCE](#)
-  [Semtech Corporation](#) Information

Optimize Your Supply Chain with WIN SOURCE Solutions

-  Global Sourcing Solution
-  Obsolete Management
-  Cost Control Management
-  Shortage Management
-  Alternative Solution
-  Excess Inventory Management