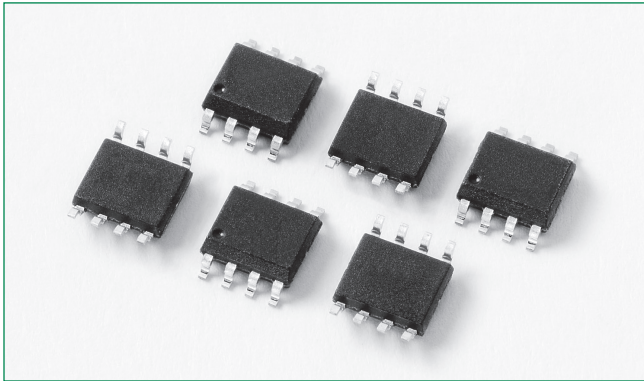




**THE DATASHEET OF  
SP03-6BTG**



**SP03-6 Series 6V 150A Diode Array**



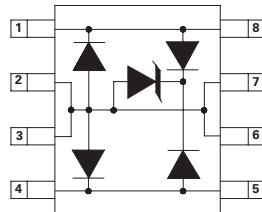
**Description**

This new broadband protection component from Littelfuse provides overvoltage protection for applications such as 10/100/1000 BaseT Ethernet, T3/E3 DS3 interfaces, ADSL2+, and VDSL2+. This new protector combines the TVS diode element with a diode rectifier bridge to provide both longitudinal and differential protection in one package. This innovative design results in a capacitive loading characteristic that is log-linear with respect to the signal voltage across the device. This reduces intermodulation (IM) distortion caused by a typical solid-state protection solution.

**Agency Approvals**

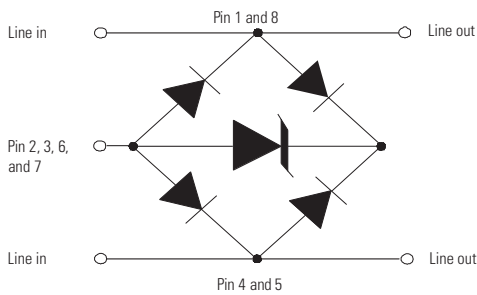
Agency	Agency File Number
	E128662

**Pinout**



SOIC-8 (Top View)

**Functional Block Diagram**



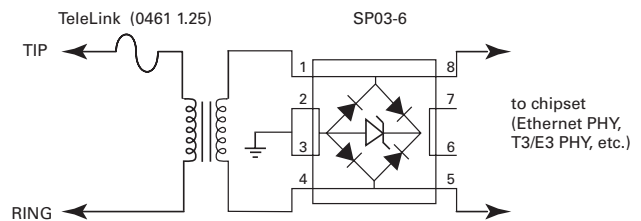
**Features**

- RoHS-compliant and lead-free
- SOIC-8 surface mount package (JEDEC MS-012)
- Low insertion loss, log-linear capacitance
- Combined longitudinal and differential protection
- Clamping speed of nanoseconds
- UL Recognized compound meeting flammability rating V-0
- Lightning, 150A (8/20 as defined in IEC 61000-4-5 2nd Edition)
- Low clamping voltage

**Applications**

- T1/E1 Line cards
- T3/E3 and DS3 Interfaces
- STS-1 Interfaces
- 10/100/1000 BaseT Ethernet

**Application Example**



This schematic shows a high-speed data interface protection solution. The [SP03-6](#) provides both metallic (differential) and longitudinal (common mode) protection from lightning induced surge events. Its surge rating is compatible with the intra-building surge requirements of Telcordia's GR-1089-CORE, and the Basic Level Recommendations of ITU K.20 and K.21. This component protects against both positive and negative induced surge events. The TeleLink fuse provides overcurrent protection for the long term 50/60 Hz power fault events.

**Additional Information**



Datasheet



Resources



Samples

Life Support Note:

**Not Intended for Use in Life Support or Life Saving Applications**

The products shown herein are not designed for use in life sustaining or life saving applications unless otherwise expressly indicated.

**Absolute Maximum Ratings**

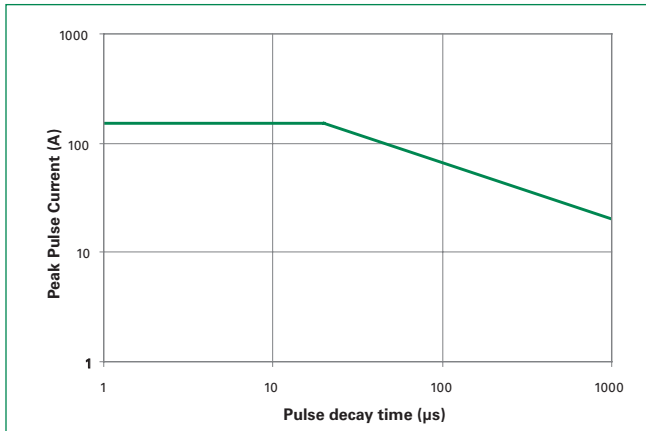
Parameter	Rating	Units
Peak Pulse Current (8/20µs)	150	A
Peak Pulse Power (8/20µs)	2800	W
IEC 61000-4-2, Contact Discharge, (Level 4)	30	kV
IEC 61000-4-2, Air Discharge, (Level 4)	30	kV
IEC 61000-4-5, 2nd Edition (8/20)	100	A
Telcordia GR 1089 (Intra-Building) (2/10µs)	150	A
ITU K.20 (5/310µs)	40	A

*CAUTION: Stresses above those listed in "Absolute Maximum Ratings" may cause permanent damage to the component. This is a stress only rating and operation of the device at these or any other conditions above those indicated in the operational sections of this specification is not implied.*

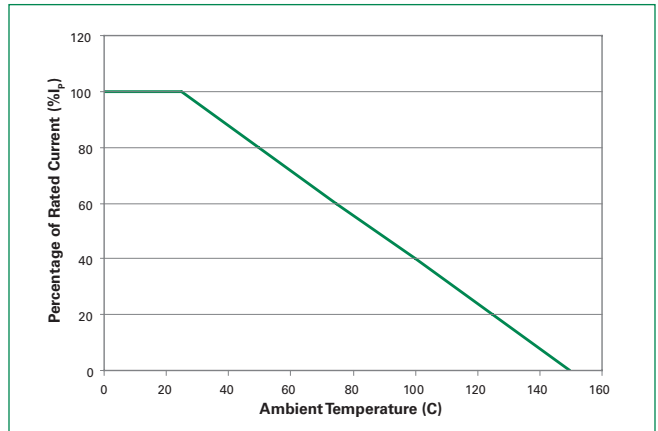
**Electrical Characteristics (T<sub>OP</sub> = 25°C)**

Parameter	Symbol	Test Conditions	Min	Typ	Max	Units
Reverse Stand-Off Voltage	V <sub>RWM</sub>	-	-	-	6	V
Reverse Breakdown Voltage	V <sub>BR</sub>	I <sub>T</sub> = 1mA	6.8	-	-	V
Reverse Leakage Current	I <sub>R</sub>	V <sub>RWM</sub> = 6V, T = 25°C	-	-	25	µA
Clamping Voltage, Line-Ground	V <sub>C</sub>	I <sub>pp</sub> = 50A, t <sub>p</sub> = 8/20 µs	-	-	15	V
Clamping Voltage, Line-Ground	V <sub>C</sub>	I <sub>pp</sub> = 100A, t <sub>p</sub> = 8/20 µs	-	-	20	V
Junction Capacitance	C <sub>j</sub> (Line-Ground)	Between I/O Pins and Ground V <sub>R</sub> = 0V, f = 1MHz	-	16	25	pF
	C <sub>j</sub> (Line-Line)	Between I/O Pins V <sub>R</sub> = 0V, f = 1MHz	-	8	12	pF

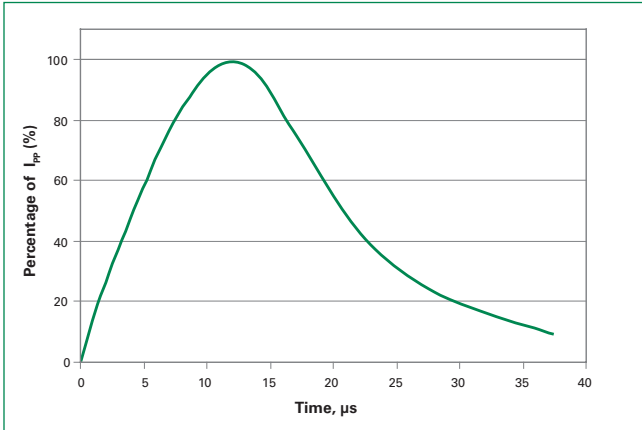
**Figure 1: Non-repetitive Peak Pulse Current vs. Pulse Time**



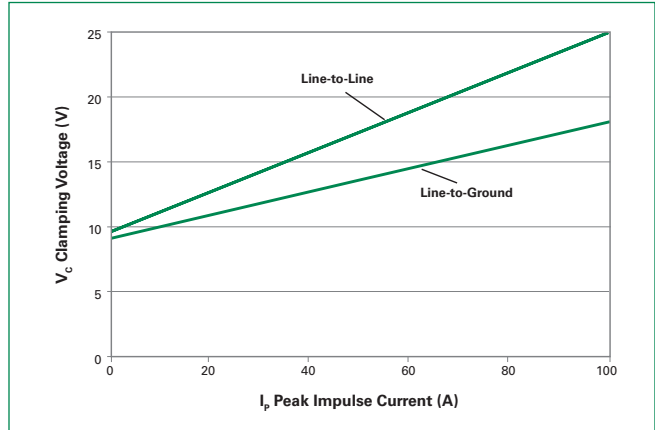
**Figure 2: Current Derating Curve**



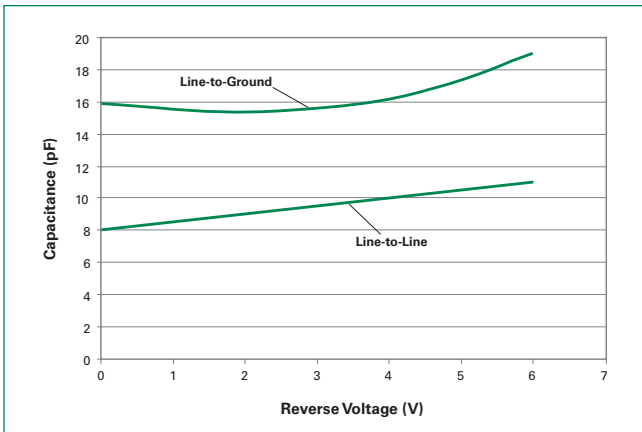
**Figure 3: Pulse Waveform**



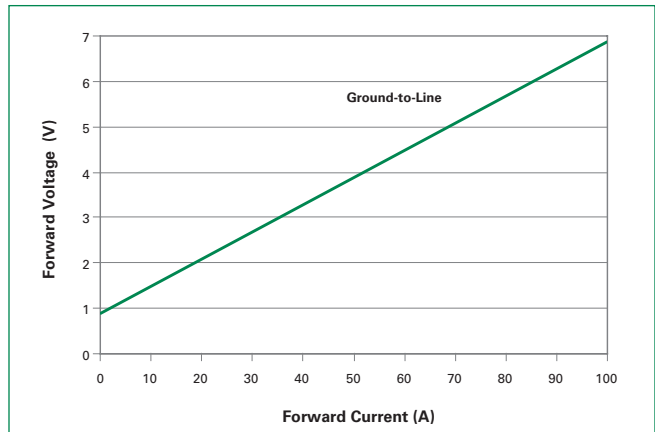
**Figure 4: Clamping Voltage vs. Peak Pulse Current**



**Figure 5: Capacitance vs. Reverse Voltage**

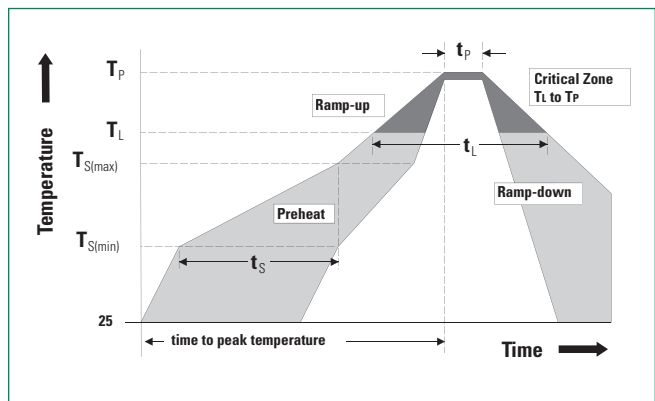


**Figure 6: Forward Voltage vs. Forward Current**

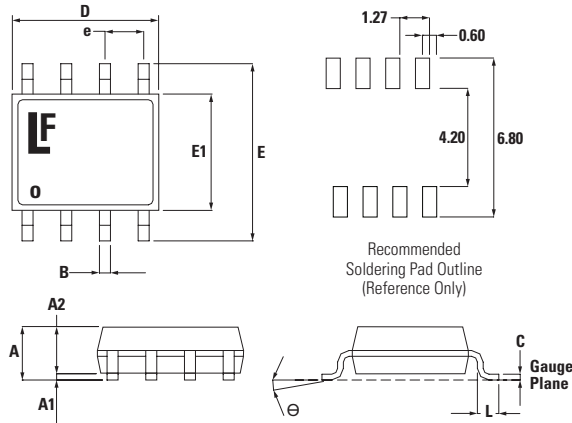


**Soldering Parameters**

<b>Reflow Condition</b>	Pb - Free assembly	
<b>Pre Heat</b>	- Temperature Min ( $T_{s(min)}$ )	150°C
	- Temperature Max ( $T_{s(max)}$ )	200°C
	- Time (min to max) ( $t_p$ )	60 - 180 secs
<b>Average ramp up rate (Liquidus) Temp (<math>T_L</math>) to peak</b>	3°C/second max	
<b><math>T_{s(max)}</math> to <math>T_L</math> - Ramp-up Rate</b>	3°C/second max	
<b>Reflow</b>	- Temperature ( $T_L$ ) (Liquidus)	217°C
	- Temperature ( $t_L$ )	60 - 150 seconds
<b>Peak Temperature (<math>T_p</math>)</b>	260 <sup>+0/-5</sup> °C	
<b>Time within 5°C of actual peak Temperature (<math>t_p</math>)</b>	20 - 40 seconds	
<b>Ramp-down Rate</b>	6°C/second max	
<b>Time 25°C to peak Temperature (<math>T_p</math>)</b>	8 minutes Max.	
<b>Do not exceed</b>	260°C	

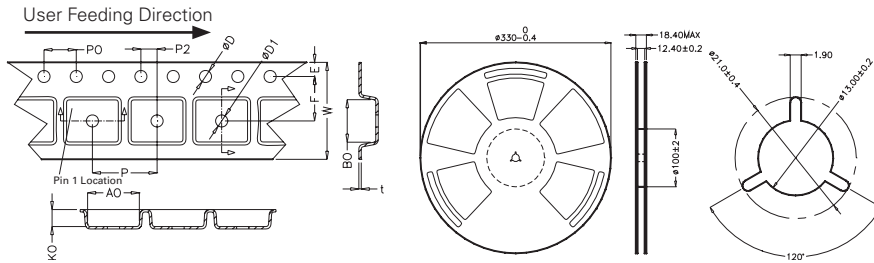


**Package Dimensions — Mechanical Drawings and Recommended Solder Pad Outline**



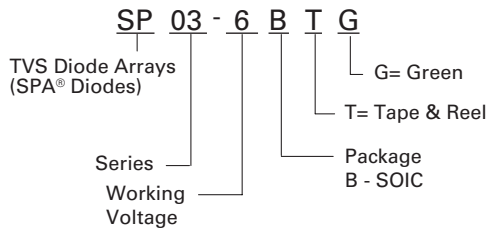
Package	SOIC			
Pins	8			
JEDEC	MS-012			
	Millimetres		Inches	
	Min	Max	Min	Max
A	1.35	1.75	0.053	0.069
A1	0.10	0.25	0.004	0.010
A2	1.25	1.65	0.049	0.065
B	0.31	0.51	0.012	0.020
c	0.17	0.25	0.007	0.010
D	4.80	5.00	0.189	0.197
E	5.80	6.20	0.228	0.244
E1	3.80	4.00	0.150	0.157
e	1.27 BSC		0.050 BSC	
L	0.40	1.27	0.016	0.050

**Embossed Carrier Tape & Reel Specification — SOIC Package**

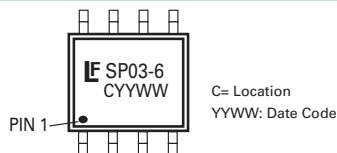


	Millimetres		Inches	
	Min	Max	Min	Max
E	1.65	1.85	0.065	0.073
F	5.4	5.6	0.213	0.22
P2	1.95	2.05	0.077	0.081
D	1.5	1.6	0.059	0.063
D1	1.50 Min		0.059 Min	
P0	3.9	4.1	0.154	0.161
10P0	40.0 ± 0.20		1.574 ± 0.008	
W	11.9	12.1	0.468	0.476
P	7.9	8.1	0.311	0.319
A0	6.3	6.5	0.248	0.256
B0	5.1	5.3	0.2	0.209
K0	2	2.2	0.079	0.087
t	0.30 ± 0.05		0.012 ± 0.002	

**Part Numbering System**



**Part Marking System**



**Ordering Information**

Part Number	Package	Marking	Min. Order Qty.
SP03-6BTG	SOIC Tape & Reel	SP03-6	2500

**Product Characteristics**

<b>Lead Plating</b>	Matte Tin
<b>Lead Material</b>	Copper Alloy
<b>Lead Coplanarity</b>	0.003 inches (0.08 mm)
<b>Substrate Material</b>	Silicon
<b>Body Material</b>	Molded
<b>Flammability</b>	UL Recognized compound meeting flammability rating V-0

**Notes :**

- All dimensions are in millimeters
- Dimensions include solder plating.
- Dimensions are exclusive of mold flash & metal burr.
- Blo is facing up for mold and facing down for trim/form, i.e. reverse trim/form.
- Package surface matte finish VDI 11-13.

## Looking for pricing, stock, or lifecycle information?

Click below to explore more details on WIN SOURCE:

 [View SP03-6BTG on WIN SOURCE](#)

 [Littelfuse Inc. Information](#)

## Optimize Your Supply Chain with WIN SOURCE Solutions

-  Global Sourcing Solution
-  Obsolete Management
-  Cost Control Management
-  Shortage Management
-  Alternative Solution
-  Excess Inventory Management