



**THE DATASHEET OF
SMS3924-040LF**



DATA SHEET

SMS392x Series: Surface-Mount General-Purpose Schottky Diodes

Applications

- High volume commercial detectors, mixers, switches, and digital pulse forming systems

Features

- Tight parameter distribution
- Available as singles and dual series pairs
- 100 percent DC tested
- Packages rated MSL1, 260 °C per JEDEC J-STD-020



Skyworks Green™ products are compliant with all applicable legislation and are halogen-free. For additional information, refer to *Skyworks Definition of Green™*, document number SQ04-0074.







Description

The SMS3922, SMS3923, and SMS3924 series of 8, 20, and 70 V rated, low-cost plastic packaged Schottky diodes are designed for general purpose use in RF applications. All diodes are fully characterized, including SPICE model parameters, and deliver tight parameter distribution, which minimizes performance variability.

Wiring configurations include singles and dual series pairs. The SMS392x series of diodes may be used at frequencies up to 6 GHz.

Table 1 describes the various packages and marking of the SMS392x series.

Table 1. SMS392x Series Packaging and Marking

			
Single	Single	Dual Series Pair	Single
SC-79 Green™	SOT-23	SC-88 Green™	SOD-882 Green™
SMS3922-079LF Marking: Cathode and S3	SMS3922-001LF Green™ Marking: XA1		SMS3922-040LF Marking: V
			SMS3923-040LF Marking: X
SMS3923-079LF Marking: Cathode and S4		SMS3923-081LF Marking: XBQ	
◆ SMS3924-079LF Marking: Cathode and S5			
			SMS3924-040LF Marking: 1
$L_S = 0.7 \text{ nH}$	$L_S = 1.5 \text{ nH}$	$L_S = 1.8 \text{ nH}$	$L_S = 0.45 \text{ nH}$

Electrical and Mechanical Specifications

The absolute maximum ratings of the SMS392x series are provided in Table 2. Electrical specifications are provided in Table 3. The associated SPICE model parameters are provided in Table 4.

A pinout and equivalent circuit diagram for the dual series pair Schottky diode (SMS3923-081LF) is shown in Figure 1. Typical performance characteristics of the SMS392x series are illustrated in Figures 2 to 6.

Package Dimensions

Package dimensions are shown in Figures 7 to 13 (odd numbers), and tape and reel dimensions are provided in Figures 8 to 14 (even numbers).

Package and Handling Information

Instructions on the shipping container label regarding exposure to moisture after the container seal is broken must be followed. Otherwise, problems related to moisture absorption may occur when the part is subjected to high temperature during solder assembly.

The SMS392x series is rated to Moisture Sensitivity Level 1 (MSL1) at 260 °C for 5 seconds. It can be used for lead or lead-free soldering. For additional information, refer to the Skyworks Application Note, *Solder Reflow Information*, document number 200164. Care must be taken when attaching this product, whether it is done manually or in a production solder reflow environment. Production quantities of this product are shipped in a standard tape and reel format.

Table 2. SMS392x Series Absolute Maximum Ratings¹

Parameter	Symbol	Minimum	Maximum	Units
Reverse voltage	C		Rated V_R	V
Forward current	I_F		50	mA
Power dissipation @ 25 °C lead temperature	P_D		75	mW
Storage temperature	T_{STG}	-65	+150	°C
Operating temperature	T_A	-65	+150	°C
Junction temperature	T_J		+150	°C
Electrostatic discharge:	ESD			
Charged Device Model (CDM), Class 1			<200	V
Human Body Model (HBM), Class 0			<50	V
Machine Model (MM), Class A			<50	V

¹ Exposure to maximum rating conditions for extended periods may reduce device reliability. There is no damage to device with only one parameter set at the limit and all other parameters set at or below their nominal value. Exceeding any of the limits listed here may result in permanent damage to the device.

ESD HANDLING: Although this device is designed to be as robust as possible, electrostatic discharge (ESD) can damage this device. This device must be protected at all times from ESD when handling or transporting. Static charges may easily produce potentials of several kilovolts on the human body or equipment, which can discharge without detection. Industry-standard ESD handling precautions should be used at all times.

Table 3. SMS392x Series Electrical Specifications¹
($T_A = +25\text{ °C}$, Per Junction Unless Otherwise Noted)

Part Number	$V_B @ 10\ \mu\text{A}$ (V, Minimum)	I_R	$C_T @ 0\ \text{V}$ (pF)	$V_F @ 1\ \text{mA}$ (mV)	Pair Configuration $\Delta V_F @ 1\ \text{mA}$ (mV, Maximum)	V_F , Maximum
SMS3922 series	8	<100 nA @ 1 V	0.63 to 1.03	280 to 340	10	<450 mV @ 10 mA
SMS3923 series	20	<500 nA @ 15 V	0.83 to 1.30	310 to 370	10	<1000 mV @ 35 mA
SMS3924 series	70	<200 nA @ 50 V	1.43 to 1.83	490 to 550	10	<1000 mV @ 15 mA

¹ Performance is guaranteed only under the conditions listed in this table.

Table 4. SPICE Model Parameters

Parameter	Units	SMS3922 Series	SMS3923 Series	SMS3924 Series
IS	A	3E-8	5E-9	2E-11
RS	Ω	9	10	11
N	–	1.08	1.05	1.08
TT	sec	8E-11	8E-11	8E-11
CJO	pF	0.7	0.9	1.5
M	–	0.26	0.24	0.40
EG	eV	0.69	0.69	0.69
XTI	–	2	2	2
FC	–	0.5	0.5	0.5
BV	V	20	46	100
IBV	A	1E-5	1E-5	1E-5
VJ	V	0.595	0.640	0.840

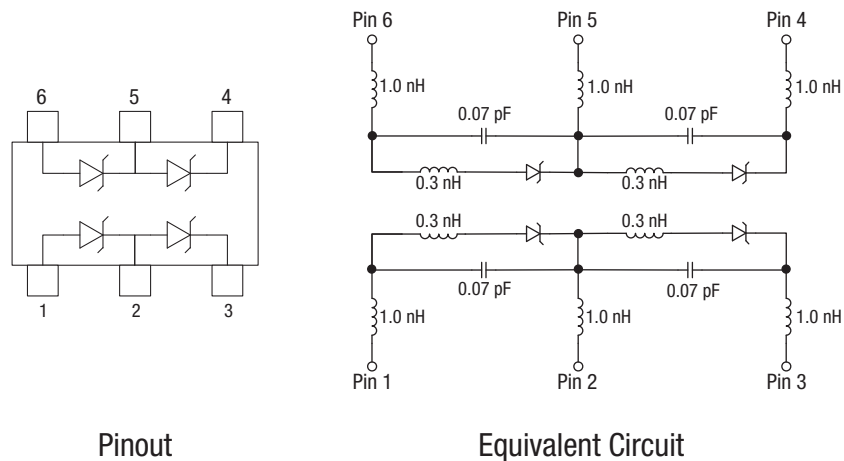

Figure 1. SMS3923-081 Dual Series Pair Pinout and Equivalent Circuit

200042-001

Typical Performance Characteristics

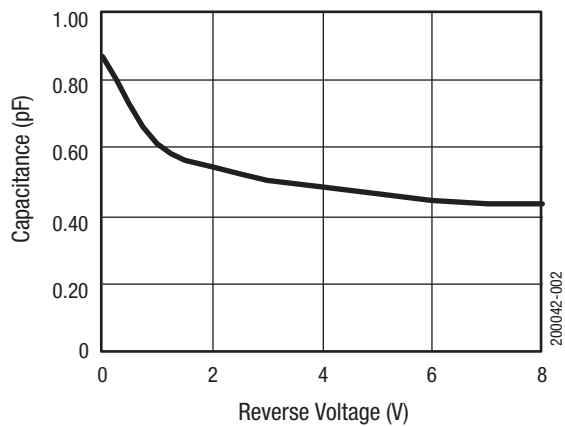

Figure 2. SMS3922 Series Total Capacitance vs Reverse Voltage

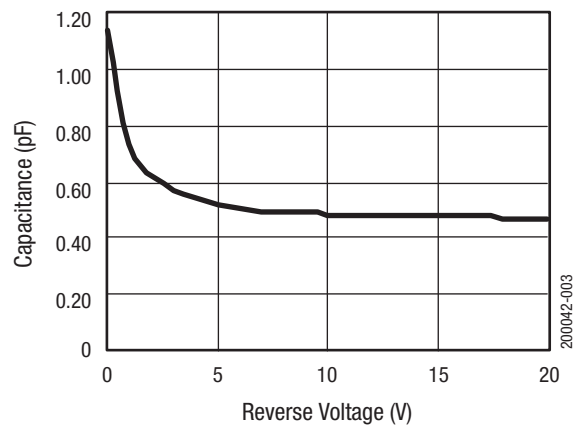

Figure 3. SMS3923 Series Total Capacitance vs Reverse Voltage

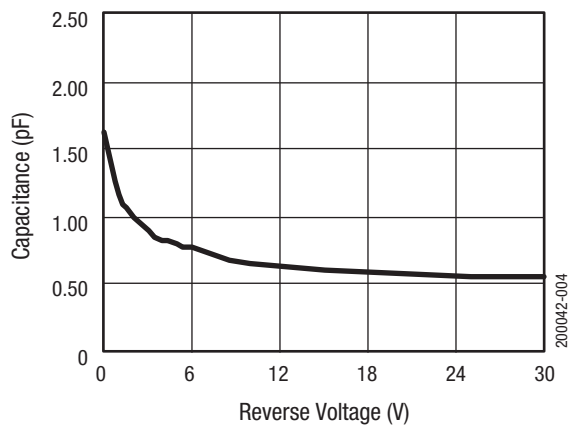

Figure 4. SMS3924 Total Capacitance vs Reverse Voltage

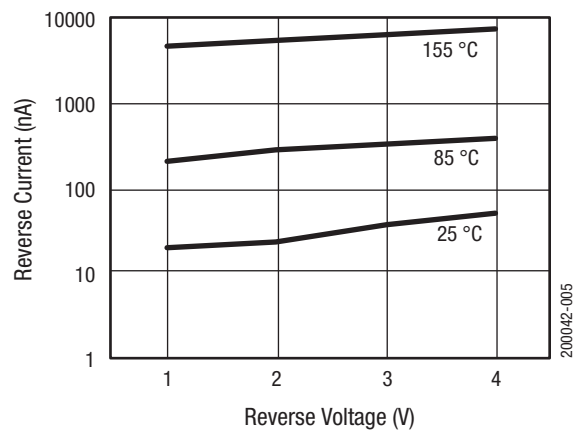

Figure 5. SMS3922 Reverse Current vs Reverse Voltage

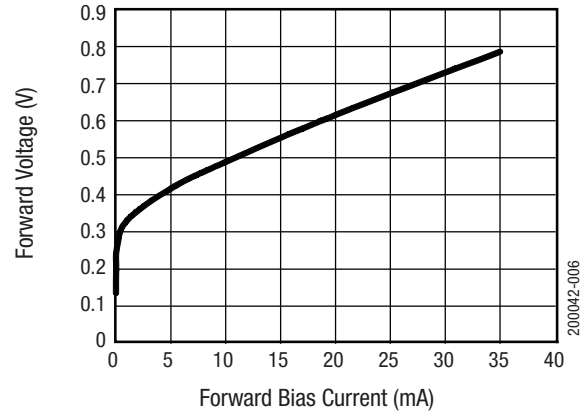
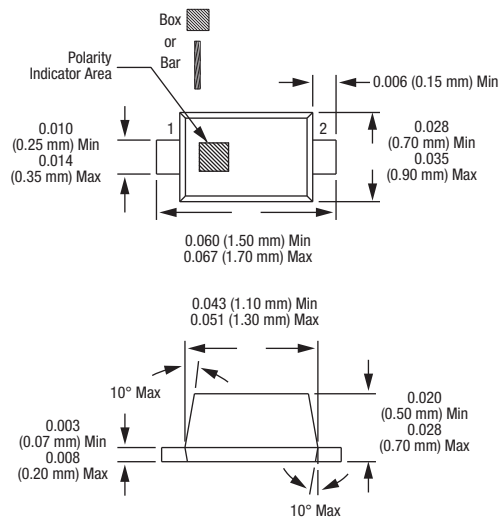
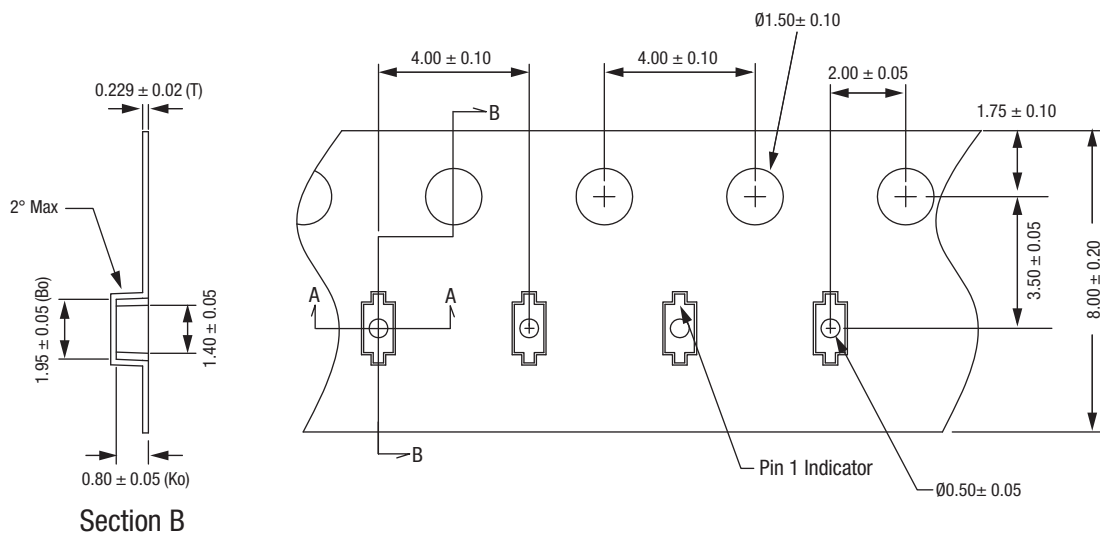

Figure 6. SMS3923-081LF Series Forward Voltage vs Forward Bias Current



Dimensions are in inches (millimeters shown in parentheses) 200042-009

Figure 7. SC-79 Package Dimension Drawing



Notes:

1. Carrier tape: black conductive polycarbonate or polystyrene.
2. Cover tape material: transparent conductive PSA.
3. Cover tape size: 5.4 mm width.
4. ESD-surface resistivity is $\leq 1 \times 10^8$ Ohms/square per EIA, JEDEC TNR Specification.
5. All measurements are in millimeters.

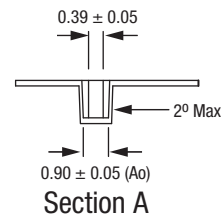

200042-010

Figure 8. SC-79 Tape and Reel Dimensions

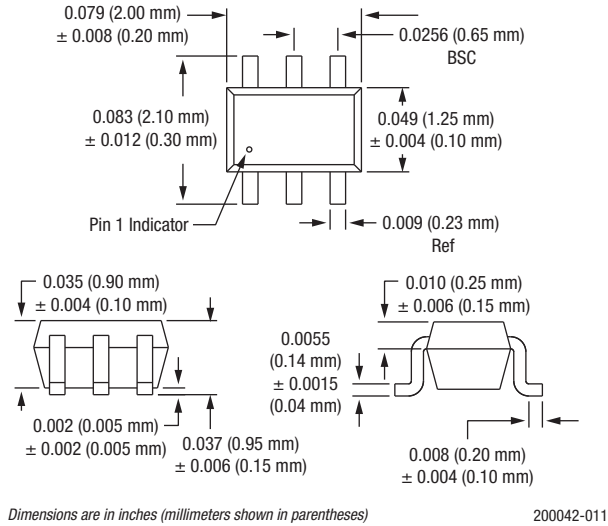

Figure 9. SC-88 Package Dimension Drawing

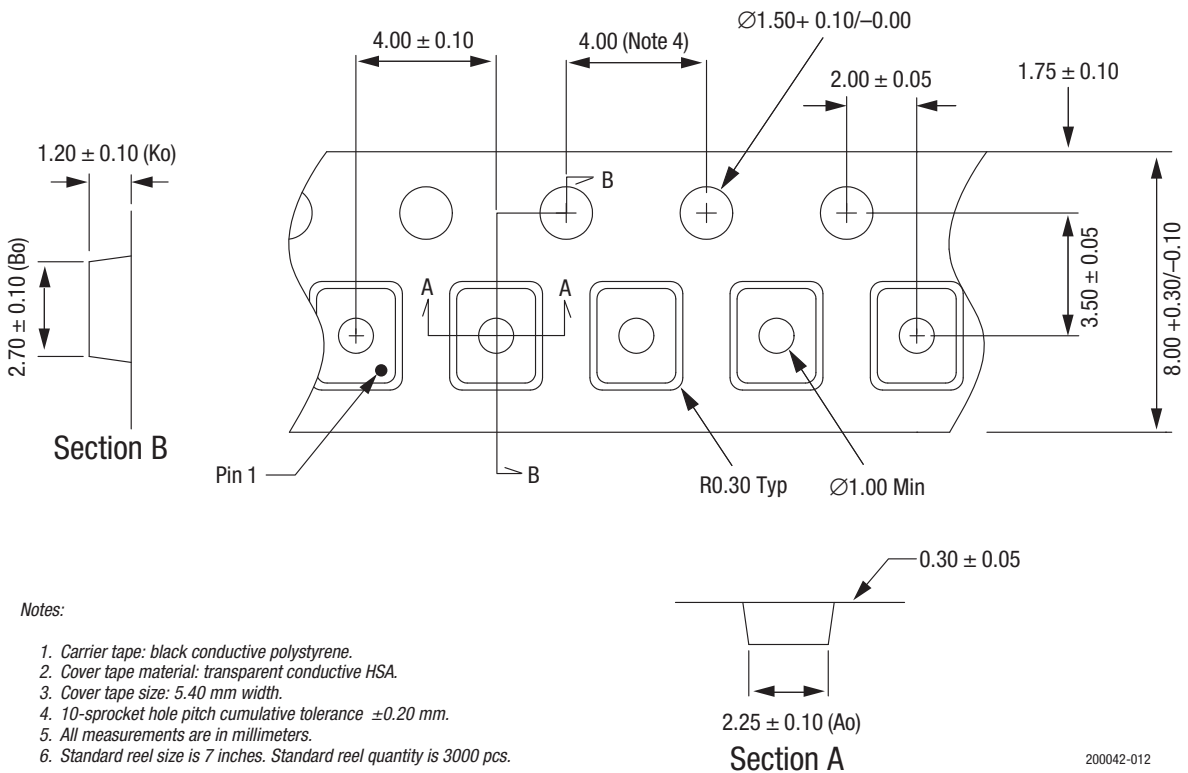
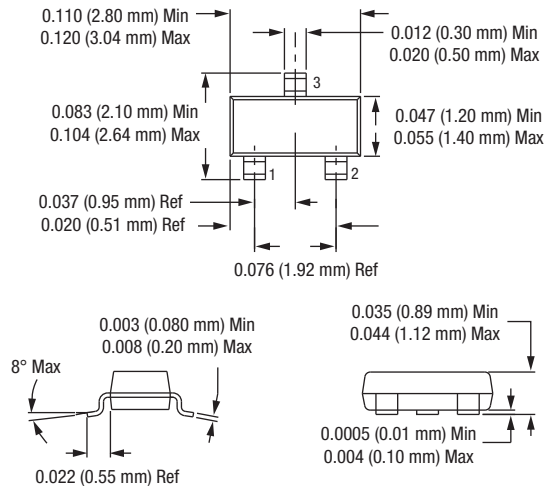

Figure 10. SC-88 Tape and Reel Dimensions



Dimensions are in inches (millimeters shown in parentheses)

200042-013

Figure 11. SOT-23 Package Dimension Drawing

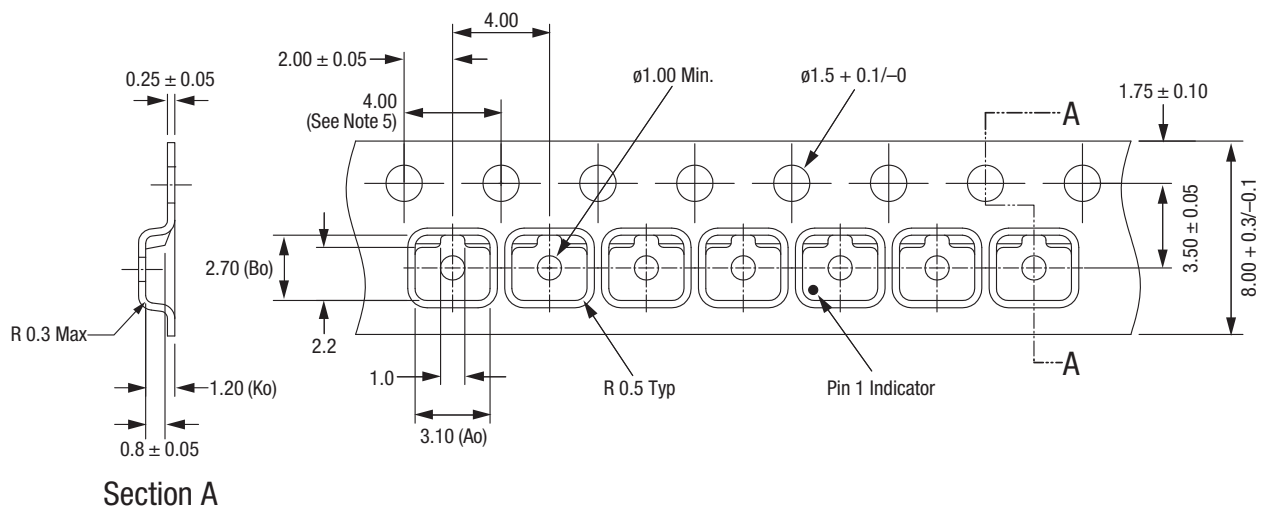

Notes:

1. Carrier tape: black conductive polycarbonate.
2. Cover tape material: transparent conductive PSA.
3. Cover tape size: 5.40 mm width.
4. Tolerance ± 0.10 mm.
5. 10-sprocket hole pitch cumulative tolerance: ± 0.2 mm.
6. All measurements are in millimeters.
7. Alternative carrier tape dimensions are:
 $A_o = 3.3$
 $B_o = 2.9$
 $K_o = 1.22$

200042-014

Figure 12. SOT-23 Tape and Reel Dimensions

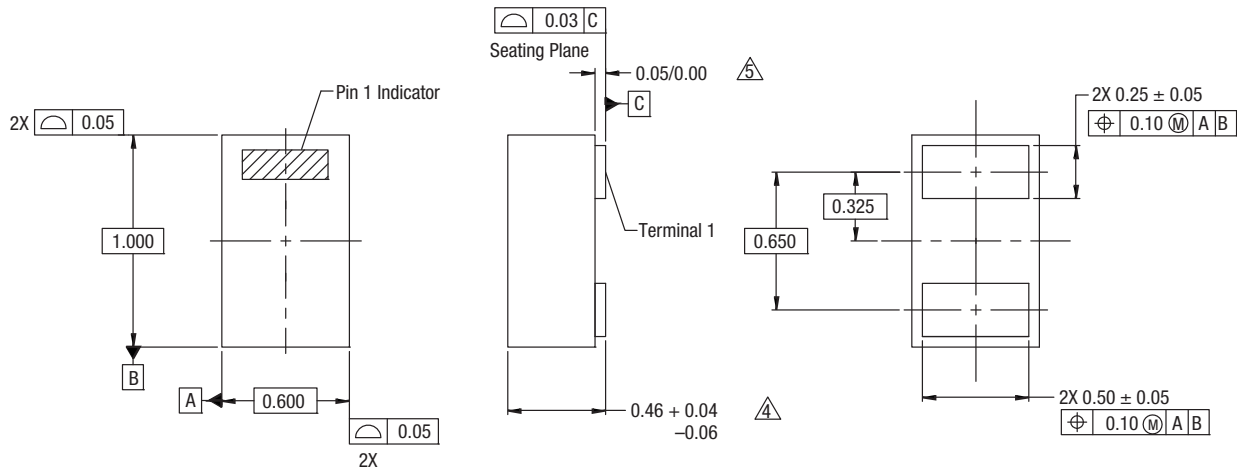

Notes:

1. All measurements are in millimeters.
2. Dimensions and tolerances according to ASME Y14.5M-1994.
3. These packages are used principally for discrete devices.
4. This dimension includes stand-off height and package body thickness, but does not include attached features, e.g., external heatsink or chip capacitors. An integral heatslug is not considered an attached feature.
5. This dimension is primarily terminal plating, but does not include small metal protrusion.

200042-015

Figure 13. SOD-882 Package Dimension Drawing

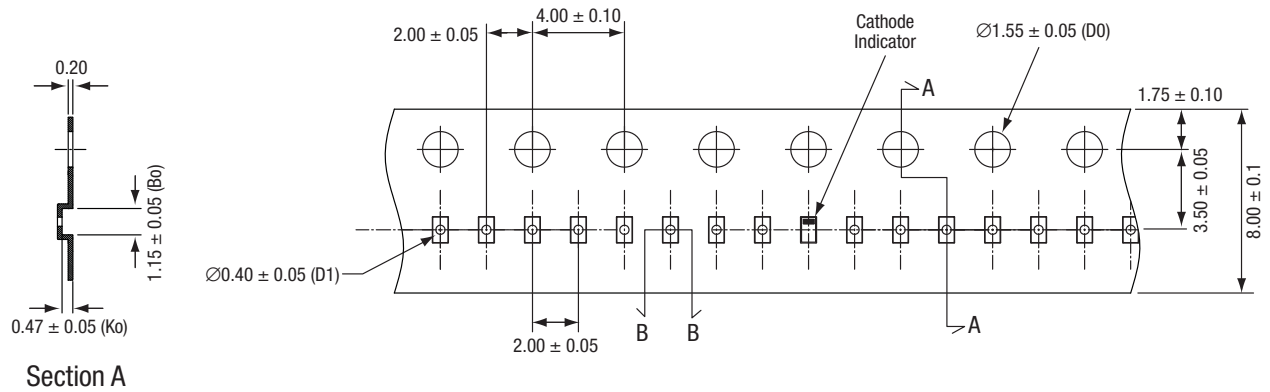

Section A

Notes:

1. Carrier tape: black conductive polycarbonate.
2. Cover tape: transparent conductive material.
3. Cover tape size: 5.4 mm width.
4. ESD surface resistivity is $\geq 1 \times 10^4 \sim \leq 1 \times 10^8$ Ohms/square.
5. All dimensions are in millimeters.

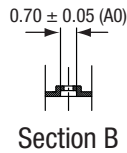

200042-016

Figure 14. SOD-882 Tape and Reel Dimensions

Copyright © 2002-2007, 2009-2016, 2018 Skyworks Solutions, Inc. All Rights Reserved.

Information in this document is provided in connection with Skyworks Solutions, Inc. ("Skyworks") products or services. These materials, including the information contained herein, are provided by Skyworks as a service to its customers and may be used for informational purposes only by the customer. Skyworks assumes no responsibility for errors or omissions in these materials or the information contained herein. Skyworks may change its documentation, products, services, specifications or product descriptions at any time, without notice. Skyworks makes no commitment to update the materials or information and shall have no responsibility whatsoever for conflicts, incompatibilities, or other difficulties arising from any future changes.

No license, whether express, implied, by estoppel or otherwise, is granted to any intellectual property rights by this document. Skyworks assumes no liability for any materials, products or information provided hereunder, including the sale, distribution, reproduction or use of Skyworks products, information or materials, except as may be provided in Skyworks Terms and Conditions of Sale.

THE MATERIALS, PRODUCTS AND INFORMATION ARE PROVIDED "AS IS" WITHOUT WARRANTY OF ANY KIND, WHETHER EXPRESS, IMPLIED, STATUTORY, OR OTHERWISE, INCLUDING FITNESS FOR A PARTICULAR PURPOSE OR USE, MERCHANTABILITY, PERFORMANCE, QUALITY OR NON-INFRINGEMENT OF ANY INTELLECTUAL PROPERTY RIGHT; ALL SUCH WARRANTIES ARE HEREBY EXPRESSLY DISCLAIMED. SKYWORKS DOES NOT WARRANT THE ACCURACY OR COMPLETENESS OF THE INFORMATION, TEXT, GRAPHICS OR OTHER ITEMS CONTAINED WITHIN THESE MATERIALS. SKYWORKS SHALL NOT BE LIABLE FOR ANY DAMAGES, INCLUDING BUT NOT LIMITED TO ANY SPECIAL, INDIRECT, INCIDENTAL, STATUTORY, OR CONSEQUENTIAL DAMAGES, INCLUDING WITHOUT LIMITATION, LOST REVENUES OR LOST PROFITS THAT MAY RESULT FROM THE USE OF THE MATERIALS OR INFORMATION, WHETHER OR NOT THE RECIPIENT OF MATERIALS HAS BEEN ADVISED OF THE POSSIBILITY OF SUCH DAMAGE.

Skyworks products are not intended for use in medical, lifesaving or life-sustaining applications, or other equipment in which the failure of the Skyworks products could lead to personal injury, death, physical or environmental damage. Skyworks customers using or selling Skyworks products for use in such applications do so at their own risk and agree to fully indemnify Skyworks for any damages resulting from such improper use or sale.

Customers are responsible for their products and applications using Skyworks products, which may deviate from published specifications as a result of design defects, errors, or operation of products outside of published parameters or design specifications. Customers should include design and operating safeguards to minimize these and other risks. Skyworks assumes no liability for applications assistance, customer product design, or damage to any equipment resulting from the use of Skyworks products outside of stated published specifications or parameters.

Skyworks and the Skyworks symbol are trademarks or registered trademarks of Skyworks Solutions, Inc. or its subsidiaries in the United States and other countries. Third-party brands and names are for identification purposes only, and are the property of their respective owners. Additional information, including relevant terms and conditions, posted at www.skyworksinc.com, are incorporated by reference.

Looking for pricing, stock, or lifecycle information?

Click below to explore more details on WIN SOURCE:

-  [View SMS3924-040LF on WIN SOURCE](#)
-  [Skyworks Solutions Inc. Information](#)

Optimize Your Supply Chain with WIN SOURCE Solutions

-  Global Sourcing Solution
-  Obsolete Management
-  Cost Control Management
-  Shortage Management
-  Alternative Solution
-  Excess Inventory Management