



**THE DATASHEET OF  
ESD5V3S1B02LRHE6327XTSA1**



**Silicon TVS Diode**

- ESD / transient protection of data and power lines in low voltage applications according to:  
IEC61000-4-2 (ESD): ± 25 kV (air) 20 kV (contact)  
IEC61000-4-4 (EFT): 50 A / 2.5 kV (5/50 ns)  
IEC61000-4-5 (surge): 5.5 A / 80 W (8/20 µs)
- Small form factor (0402 inch):  
1.0 x 0.6 x 0.4 mm<sup>3</sup>
- Bi-directional, symmetrical working voltage up to ± 5.3 V
- Ultralow and symmetric clamping voltage
- Ultralow dynamic resistance **0.4 Ω**
- Very fast response time
- Pb-free (RoHS compliant) package

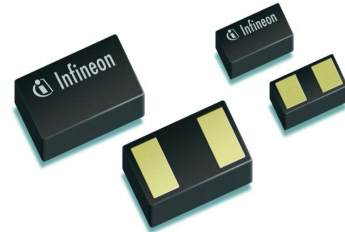

**Applications**

Recommended to protect audio lines / microphone lines / speaker and headset systems in:

- Mobile phones
- Mobile TV
- Set top boxes
- MP3 players
- Minidisc players
- Portable entertainment electronics



**ESD5V3S1B-02LRH**

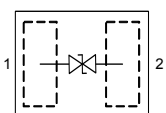

Type	Package	Configuration	Marking
ESD5V3S1B-02LRH	TSLP-2-17	1 line, bi-directional	E1

**Maximum Ratings** at  $T_A = 25^\circ\text{C}$ , unless otherwise specified

Parameter	Symbol	Value	Unit
ESD air / contact discharge <sup>1)</sup>	$V_{\text{ESD}}$	25 / 20	kV
Peak pulse current ( $t_p = 8 / 20 \mu\text{s}$ ) <sup>2)</sup>	$I_{\text{pp}}$	5.5	A
Peak pulse power ( $t_p = 8 / 20 \mu\text{s}$ ) <sup>2)</sup>	$P_{\text{pk}}$	80	W
Operating temperature range	$T_{\text{op}}$	-55...125	°C
Storage temperature	$T_{\text{stg}}$	-65...150	

**Electrical Characteristics** at  $T_A = 25^\circ\text{C}$ , unless otherwise specified

Parameter	Symbol	Values			Unit
		min.	typ.	max.	

**Characteristics**

Reverse working voltage	$V_{\text{RWM}}$	-5.3	-	5.3	V	
Breakdown voltage $I_{(\text{BR})} = 1 \text{ mA}$	$V_{(\text{BR})}$	6	-	-		
Reverse current $V_R = 3.3 \text{ V}$	$I_R$	-	-	0.1	$\mu\text{A}$	
Clamping voltage $I_{\text{PP}} = 1 \text{ A}, t_p = 8/20 \mu\text{s}$ <sup>2)</sup> $I_{\text{PP}} = 3.5 \text{ A}, t_p = 8/20 \mu\text{s}$ <sup>2)</sup> $I_{\text{PP}} = 5.5 \text{ A}, t_p = 8/20 \mu\text{s}$ <sup>2)</sup>	$V_{\text{CL}}$	-	8 10 11	10 12 13	V	
Diode capacitance $V_R = 0 \text{ V}, f = 1 \text{ MHz}$	$C_T$	-	17.5	20		pF
$V_R = 2.5 \text{ V}, f = 1 \text{ MHz}$		-	14.5	-		
Dynamic resistance <sup>3)</sup> ( $t_p = 30 \text{ ns}$ )	$R_D$	-	0.4	-	$\Omega$	

<sup>1)</sup>  $V_{\text{ESD}}$  according to IEC61000-4-2

<sup>2)</sup>  $I_{\text{pp}}$  according to IEC61000-4-5

<sup>3)</sup> according to TLP tests

**Power derating curve  $P_{pk} = f(T_A)$**

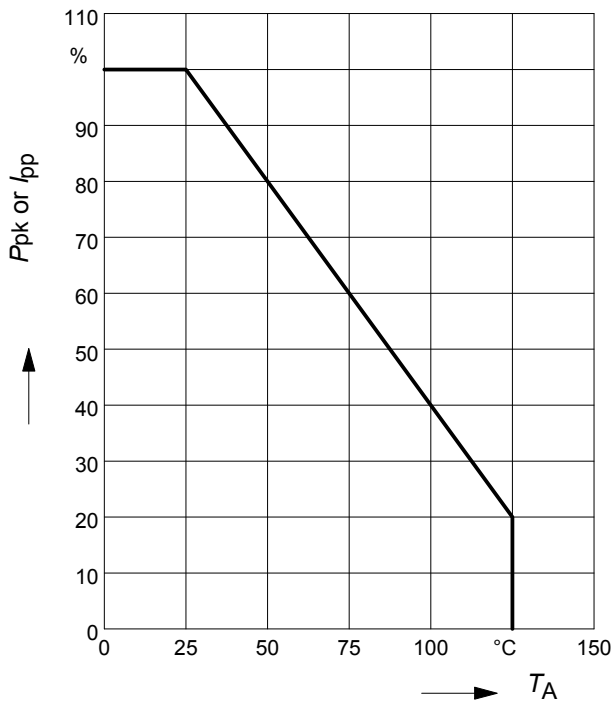

**Clamping voltage,  $V_{cl} = f(I_{pp})$**

$t_p = 8 / 20 \mu s$

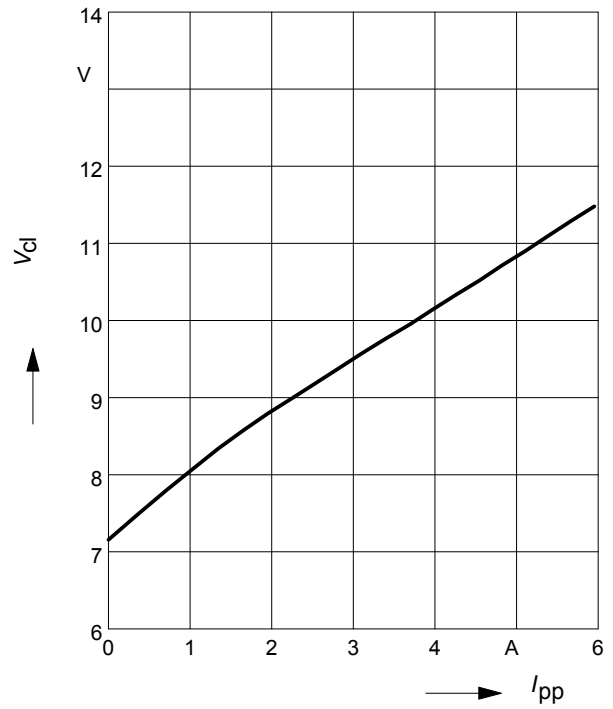

**Reverse current  $I_R = f(T_A)$**

$V_R = 3.3 V$

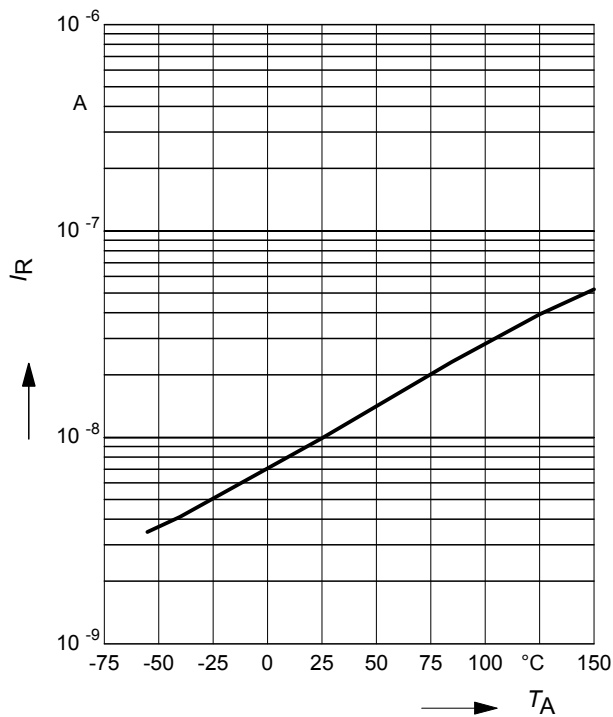

**Breakdown voltage  $V_{BR} = f(T_A)$**

$I_R = 1 mA$

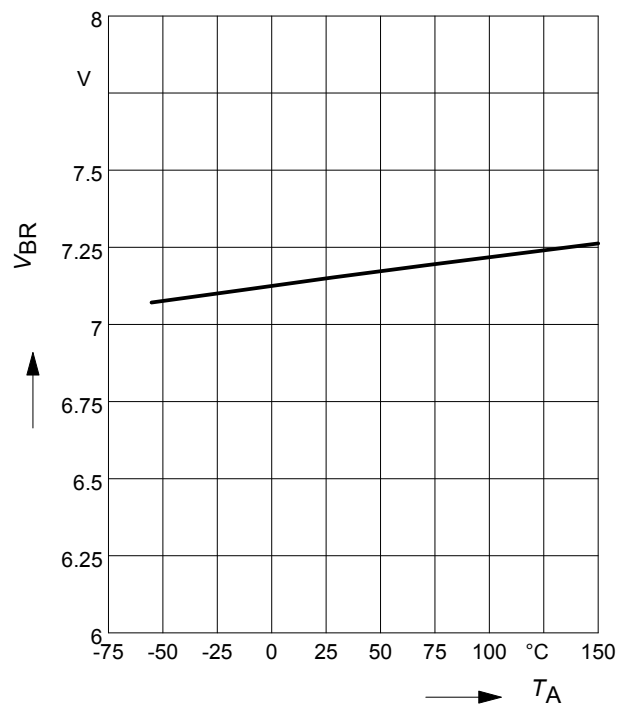

Diode capacitance  $C_T = f(V_R)$

$f = 1\text{MHz}$

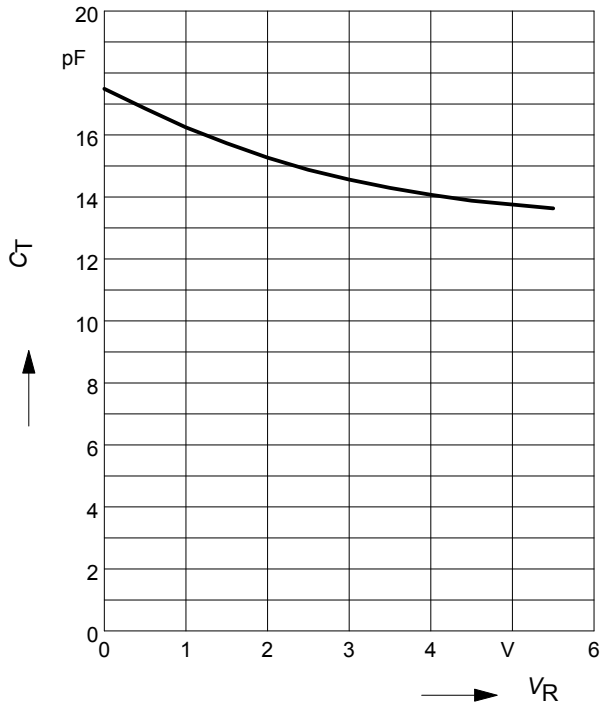

**Application example**  
single channel, bi-directional

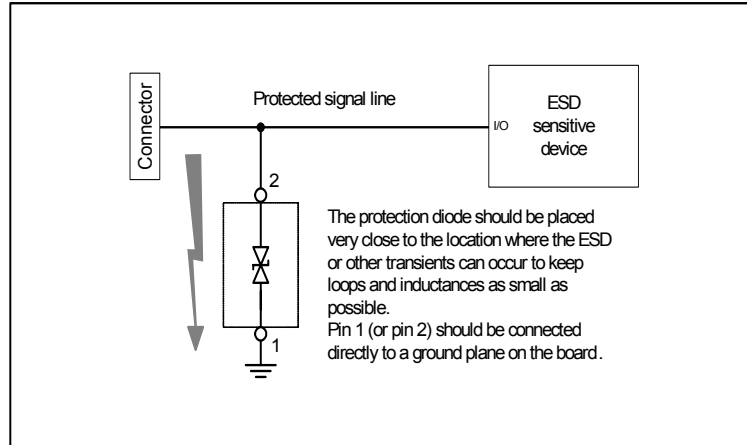

### Package Outline

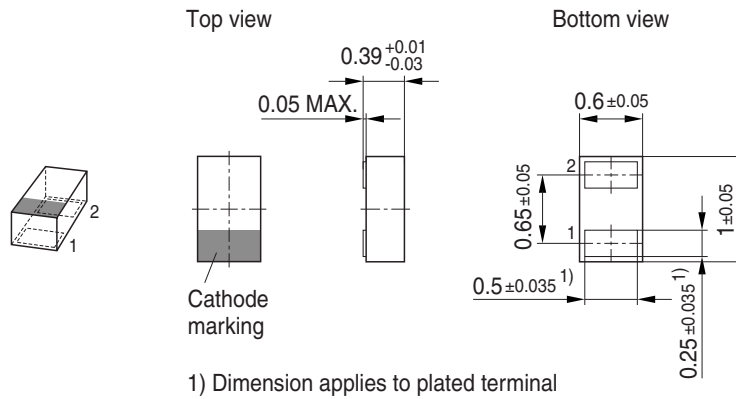

### Foot Print

For board assembly information please refer to Infineon website "Packages"

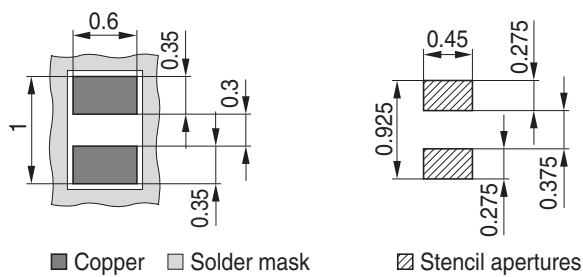

### Marking Layout (Example)

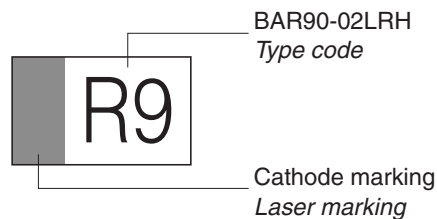

### Standard Packing

Reel ø180 mm = 15.000 Pieces/Reel  
 Reel ø330 mm = 50.000 Pieces/Reel (optional)

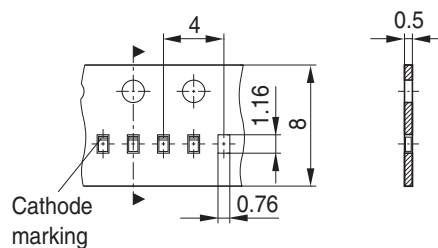

**Edition 2009-11-16**

**Published by  
Infineon Technologies AG  
81726 Munich, Germany**

**© 2009 Infineon Technologies AG  
All Rights Reserved.**

### **Legal Disclaimer**

The information given in this document shall in no event be regarded as a guarantee of conditions or characteristics. With respect to any examples or hints given herein, any typical values stated herein and/or any information regarding the application of the device, Infineon Technologies hereby disclaims any and all warranties and liabilities of any kind, including without limitation, warranties of non-infringement of intellectual property rights of any third party.

### **Information**

For further information on technology, delivery terms and conditions and prices, please contact the nearest Infineon Technologies Office ([<www.infineon.com>](http://www.infineon.com)).



### **Warnings**

Due to technical requirements, components may contain dangerous substances. For information on the types in question, please contact the nearest Infineon Technologies Office.

Infineon Technologies components may be used in life-support devices or systems only with the express written approval of Infineon Technologies, if a failure of such components can reasonably be expected to cause the failure of that life-support device or system or to affect the safety or effectiveness of that device or system. Life support devices or systems are intended to be implanted in the human body or to support and/or maintain and sustain and/or protect human life. If they fail, it is reasonable to assume that the health of the user or other persons may be endangered.

## Looking for pricing, stock, or lifecycle information?

Click below to explore more details on WIN SOURCE:

-  [View ESD5V3S1B02LRHE6327XTSA1 on WIN SOURCE](#)
-  [Infineon Technologies Information](#)

## Optimize Your Supply Chain with WIN SOURCE Solutions

-  Global Sourcing Solution
-  Obsolete Management
-  Cost Control Management
-  Shortage Management
-  Alternative Solution
-  Excess Inventory Management