



# THE DATASHEET OF STGB3NB60SDT4





# STGB3NB60SD

N-CHANNEL 3A - 600V D<sup>2</sup>PAK

Power MESH™ IGBT

TYPE	V <sub>CES</sub>	V <sub>CE(sat)</sub>	I <sub>c</sub>
STGB3NB60SD	600 V	<1.5 V	3 A

- HIGH INPUT IMPEDANCE (VOLTAGE DRIVEN)
- VERY LOW ON-VOLTAGE DROP (V<sub>cesat</sub>)
- HIGH CURRENT CAPABILITY
- OFF LOSSES INCLUDE TAIL CURRENT
- INTEGRATED FREEWHEELING DIODE
- SURFACE-MOUNTING D<sup>2</sup>PAK (TO-263) POWER PACKAGE IN TAPE & REEL (SUFFIX "T4")

## DESCRIPTION

Using the latest high voltage technology based on a patented strip layout, STMicroelectronics has designed an advanced family of IGBTs, the PowerMESH™ IGBTs, with outstanding performances. The suffix "S" identifies a family optimized to achieve minimum on-voltage drop for low frequency applications (<1kHz).

## APPLICATIONS

- GAS DISCHARGE LAMP
- STATIC RELAYS
- MOTOR CONTROL

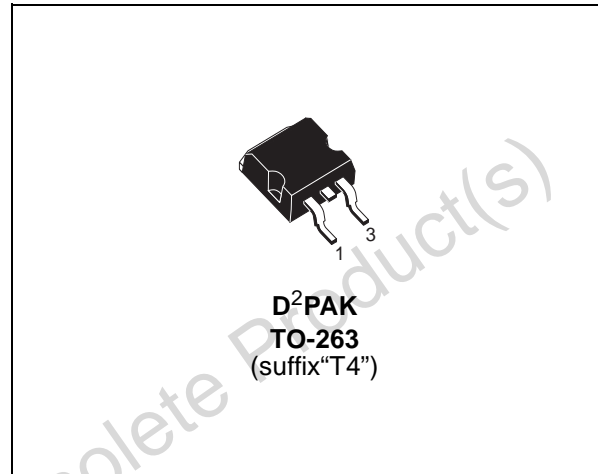

## INTERNAL SCHEMATIC DIAGRAM

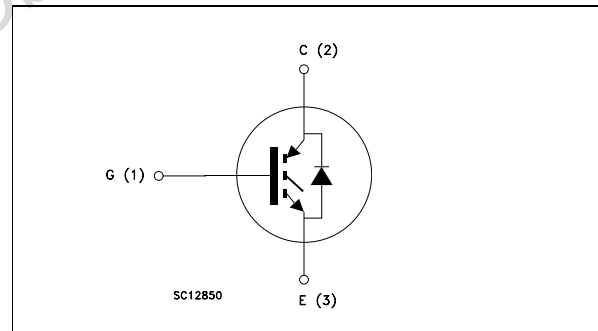

## ABSOLUTE MAXIMUM RATINGS

Symbol	Parameter	Value	Unit
V <sub>CES</sub>	Collector-Emitter Voltage (V <sub>GS</sub> = 0)	600	V
V <sub>GE</sub>	Gate-Emitter Voltage	± 20	V
I <sub>c</sub>	Collector Current (continuous) at T <sub>c</sub> =25°C	6	A
I <sub>c</sub>	Collector Current (continuous) at T <sub>c</sub> =100°C	3	A
I <sub>CM</sub> (●)	Collector Current (pulsed)	25	A
P <sub>tot</sub>	Total Dissipation at T <sub>c</sub> = 25°C	70	W
	Derating Factor	0.46	W/°C
T <sub>stg</sub>	Storage Temperature	-60 to 175	°C
T <sub>j</sub>	Max. Operating Junction Temperature	175	°C

(●)Pulse width limited by safe operating area.

## STGB3NB60SD

### THERMAL DATA

$R_{thj-case}$	Thermal Resistance Junction-case	Max	2.14	°C/W
$R_{thj-amb}$	Thermal Resistance Junction-ambient	Max	62.5	°C/W
$R_{thc-sink}$	Thermal Resistance Case-sink	Typ	0.5	°C/W

### ELECTRICAL CHARACTERISTICS ( $T_{case} = 25\text{ °C}$ unless otherwise specified)

#### OFF

Symbol	Parameter	Test Conditions	Min.	Typ.	Max.	Unit
$V_{BR(CEs)}$	Collector-Emitter Breakdown Voltage	$I_D = 250\ \mu A$ $V_{GE} = 0$	600			V
$I_{CES}$	Collector cut-off ( $V_{GE} = 0$ )	$V_{CE} = \text{Max Rating}$ $T_j = 25\text{ °C}$ $V_{CE} = \text{Max Rating}$ $T_j = 125\text{ °C}$			10 100	$\mu A$ $\mu A$
$I_{GSS}$	Gate-body Leakage Current ( $V_{DS} = 0$ )	$V_{GS} = \pm 20V$ $V_{CE} = 0$			$\pm 100$	nA

#### ON (\*)

Symbol	Parameter	Test Conditions	Min.	Typ.	Max.	Unit
$V_{GE(th)}$	Gate Threshold Voltage	$V_{CE} = V_{GE}$ $I_C = 250\ \mu A$	2.5		5	V
$V_{CE(SAT)}$	Collector-Emitter Saturation Voltage	$V_{GE} = 15\text{ V}$ $I_C = 1.5\text{ A}$ $V_{GE} = 15\text{ V}$ $I_C = 3\text{ A}$ $V_{GE} = 15\text{ V}$ $I_D = 3\text{ A}$ $T_j = 125\text{ °C}$		1 1.2 1.1	1.5	V V V

#### DYNAMIC

Symbol	Parameter	Test Conditions	Min.	Typ.	Max.	Unit
$g_{fs}$	Forward Transconductance	$V_{CE} = 25\text{ V}$ $I_C = 3\text{ A}$	1.7	2.5		S
$C_{ies}$	Input Capacitance	$V_{CE} = 25V$ $f = 1\text{ MHz}$ $V_{GE} = 0$		255	330	pF
$C_{oes}$	Output Capacitance			30	40	pF
$C_{res}$	Reverse Transfer Capacitances			5.6	7	pF
$Q_G$	Total Gate Charge	$V_{CE} = 480V$ $I_C = 3\text{ A}$ $V_{GE} = 15\text{ V}$		18		nC
$Q_{GE}$	Gate-Emitter Charge			5.4		nC
$Q_{GC}$	Gate-Collector Charge			5.5		nC
$I_{CL}$	Latching Current	$V_{clamp} = 480\text{ V}$ $R_G = 1\text{ k}\Omega$ $T_j = 150\text{ °C}$	12			A

#### SWITCHING ON

Symbol	Parameter	Test Conditions	Min.	Typ.	Max.	Unit
$t_{d(on)}$ $t_r$	Delay Time Rise Time	$V_{CC} = 480\text{ V}$ $I_C = 3\text{ A}$ $V_{GE} = 15\text{ V}$ $R_G = 1\text{ k}\Omega$		125 150		ns ns
$(di/dt)_{on}$ $E_{on}$	Turn-on Current Slope Turn-on Switching Losses	$V_{CC} = 480\text{ V}$ $I_C = 3\text{ A}$ $V_{GE} = 15\text{ V}$ $R_G = 1\text{ k}\Omega$ $T_j = 125\text{ °C}$		50 1100		A/ $\mu s$ $\mu J$

**ELECTRICAL CHARACTERISTICS** (continued)

**SWITCHING OFF**

Symbol	Parameter	Test Conditions	Min.	Typ.	Max.	Unit
$t_c$	Cross-Over Time	$V_{CC} = 480\text{ V}$ $I_C = 3\text{ A}$		1.8		$\mu\text{s}$
$t_r(V_{off})$	Off Voltage Rise Time	$R_{GE} = 1\text{ k}\Omega$ $V_{GE} = 15\text{ V}$		1.0		$\mu\text{s}$
$t_d(V_{off})$	Delay Time			3.4		$\mu\text{s}$
$t_f$	Fall Time			0.72		$\mu\text{s}$
$E_{off(**)}$	Turn-off Switching Loss			1.15		mJ
$t_c$	Cross-Over Time	$V_{CC} = 480\text{ V}$ $I_C = 3\text{ A}$		2.8		$\mu\text{s}$
$t_r(V_{off})$	Off Voltage Rise Time	$R_{GE} = 1\text{ k}\Omega$ $V_{GE} = 15\text{ V}$		1.45		$\mu\text{s}$
$t_d(V_{off})$	Delay Time	$T_j = 125\text{ }^\circ\text{C}$		3.6		$\mu\text{s}$
$t_f$	Fall Time			1.2		$\mu\text{s}$
$E_{off(**)}$	Turn-off Switching Loss			1.8		mJ

**COLLECTOR-EMITTER DIODE**

Symbol	Parameter	Test Conditions	Min.	Typ.	Max.	Unit
$I_f$	Forward Current				3	A
$I_{fm}$	Forward Current pulsed				25	A
$V_f$	Forward On-Voltage	$I_f = 3\text{ A}$ $I_f = 1\text{ A}$		1.55 1.15	1.9	V V
$t_{rr}$	Reverse Recovery Time	$I_f = 3\text{ A}$ $V_R = 200\text{ V}$		1700		ns
$Q_{rr}$	Reverse Recovery Charge	$di/dt = 100\text{ A}/\mu\text{s}$ $T_j = 125\text{ }^\circ\text{C}$		4500		nC
$I_{rrm}$	Reverse Recovery Current			9.5		A

(●) Pulse width limited by max. junction temperature  
 (\*) Pulsed: Pulse duration = 300  $\mu\text{s}$ , duty cycle 1.5 %  
 (\*\*) Losses Include Also The Tail (Jedec Standardization)

**Thermal Impedance**

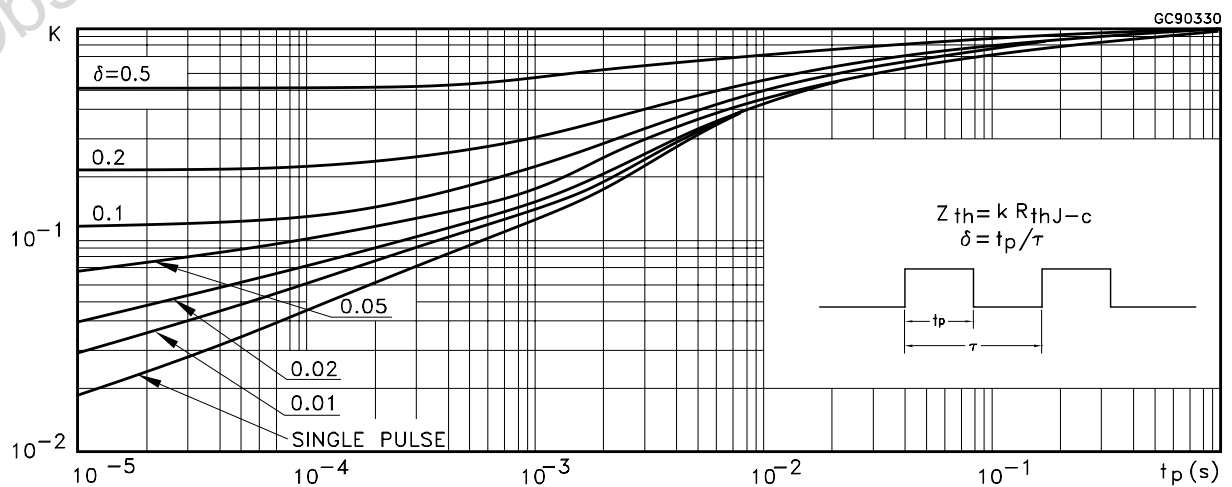

Output Characteristics

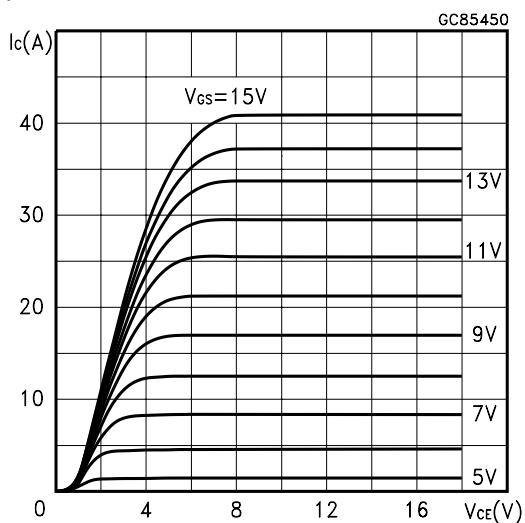

Transfer Characteristics

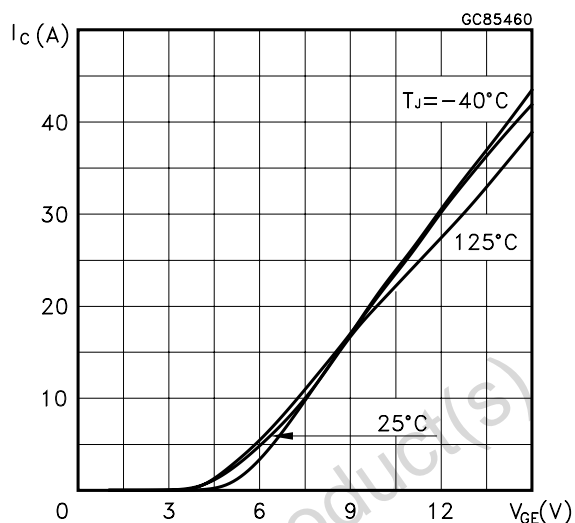

Transconductance

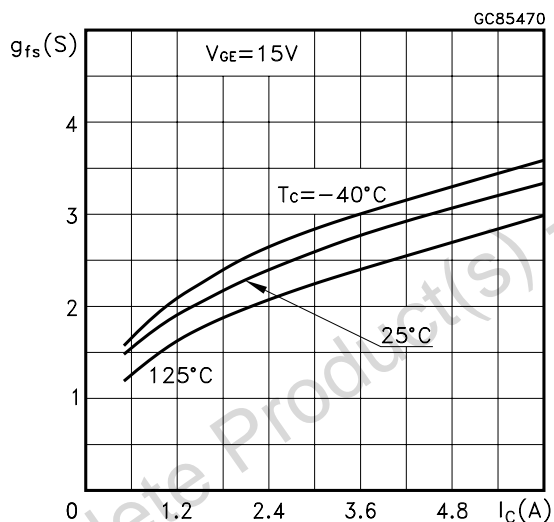

Collector-Emitter on Voltage vs Temperature

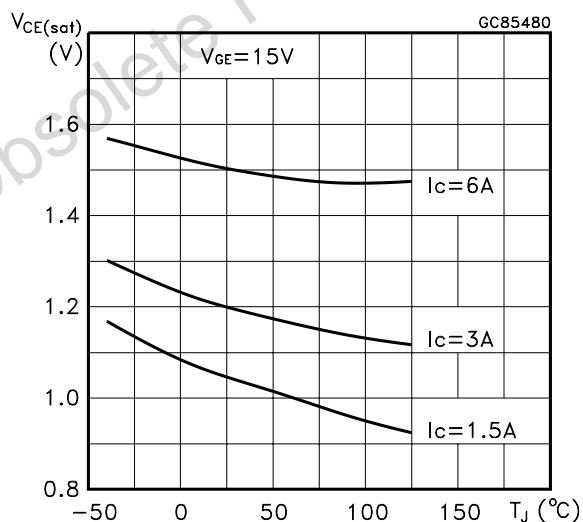

Collector-Emitter on Voltage vs Collector Current

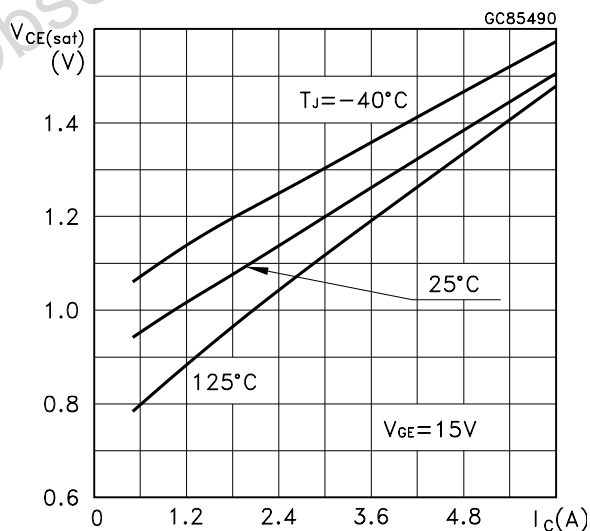

Gate Threshold vs Temperature

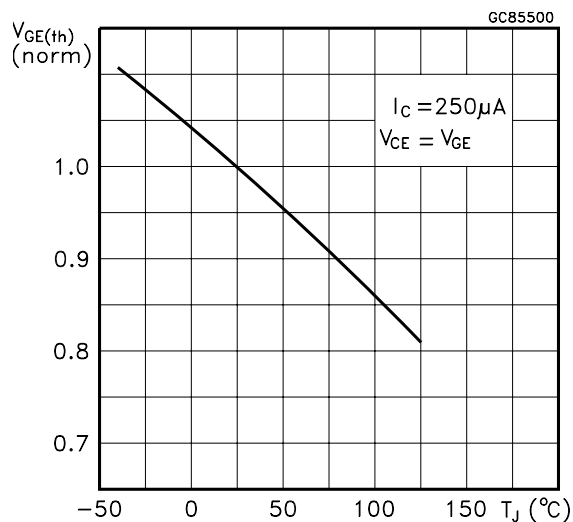

Normalized Breakdown Voltage vs Temperature

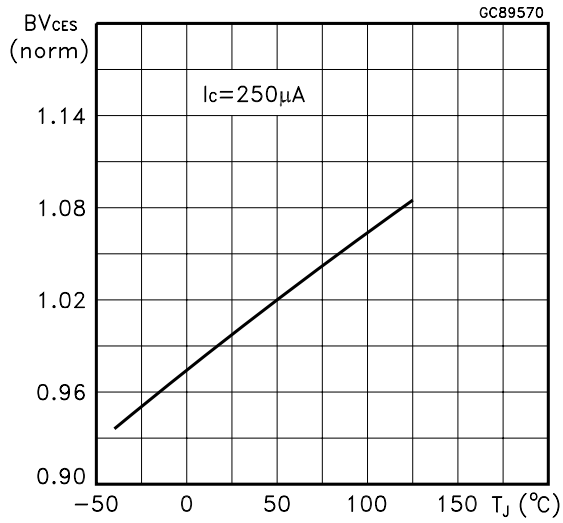

Capacitance Variations

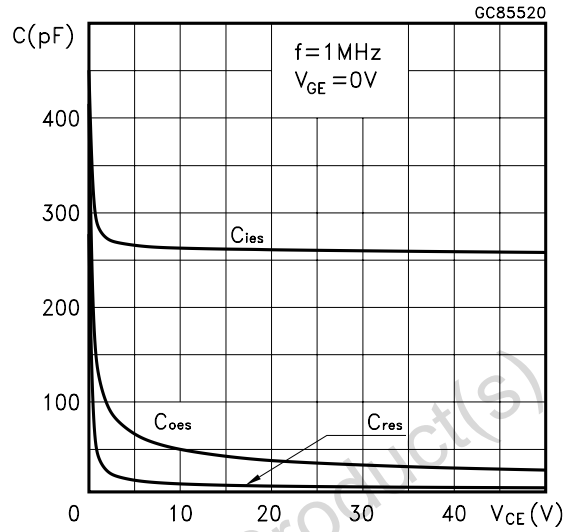

Gate charge Gate-Emitter Voltage

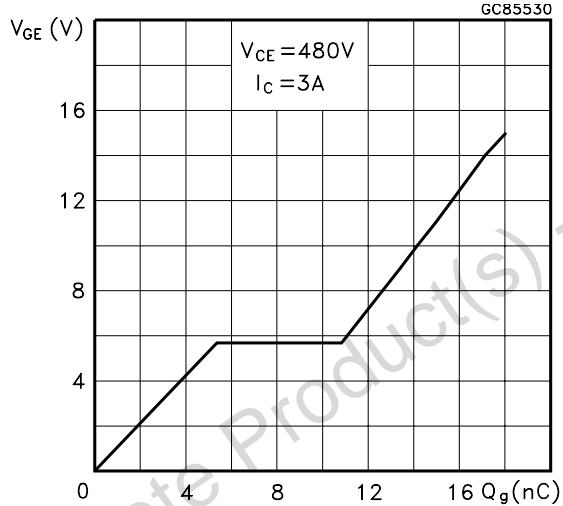

Off Switching Losses vs Ic

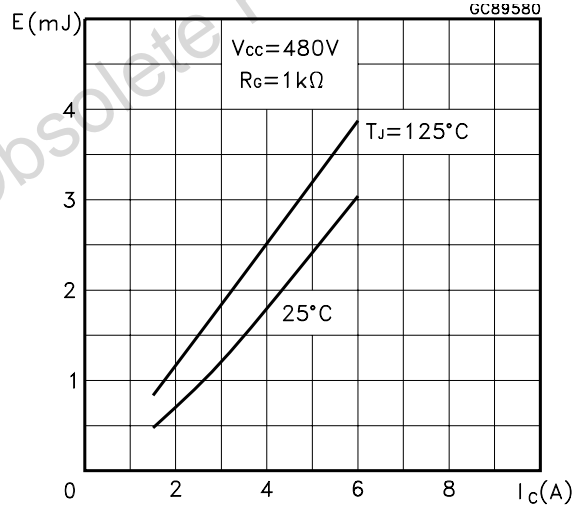

Off Switching Losses vs Tj

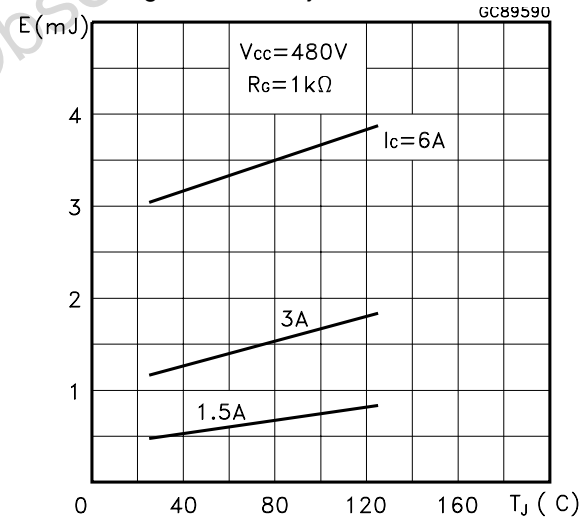

Switching Off Safe Operating Area

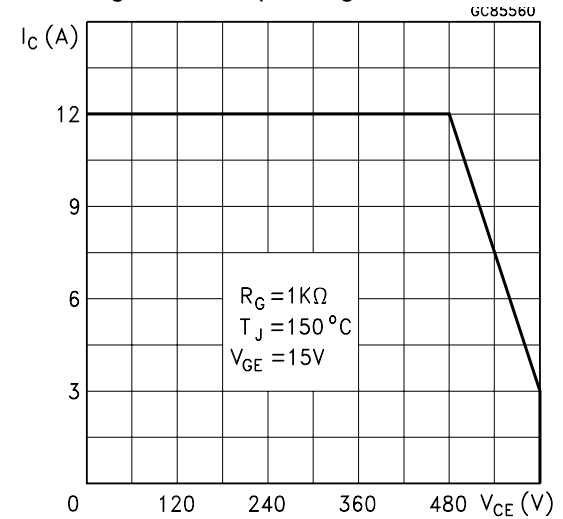

Diode Forward vs Tj

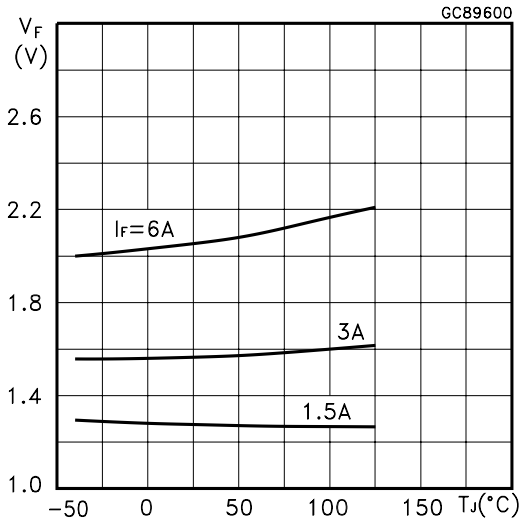
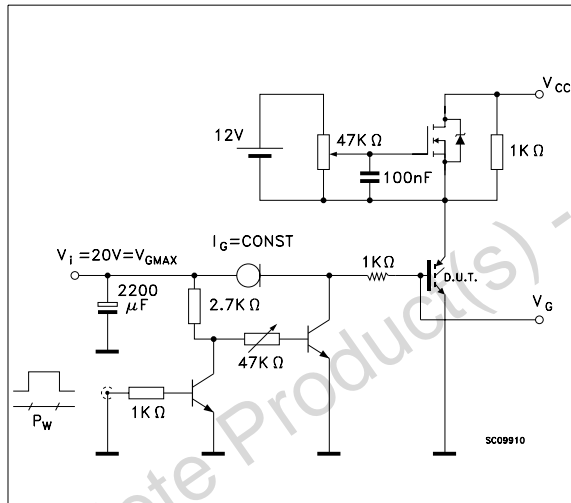

Fig. 1: Gate Charge test Circuit



Diode Forward Voltage

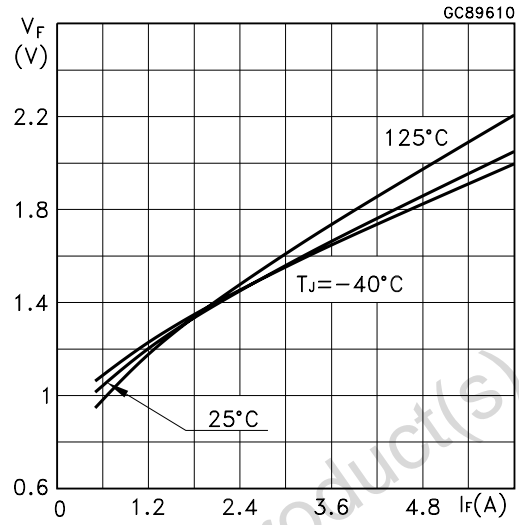

Fig. 2 Test Circuit For Inductive Load Switching

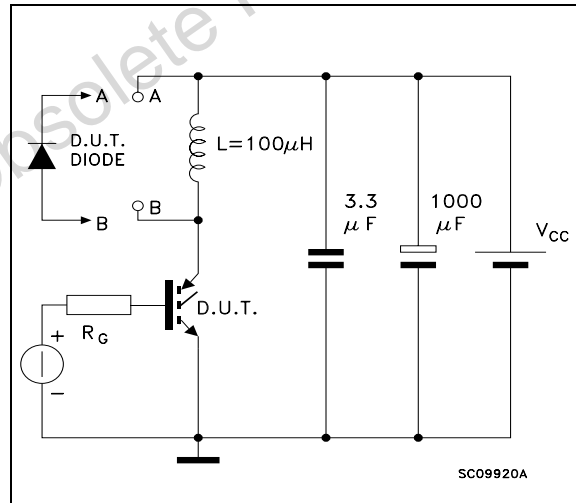
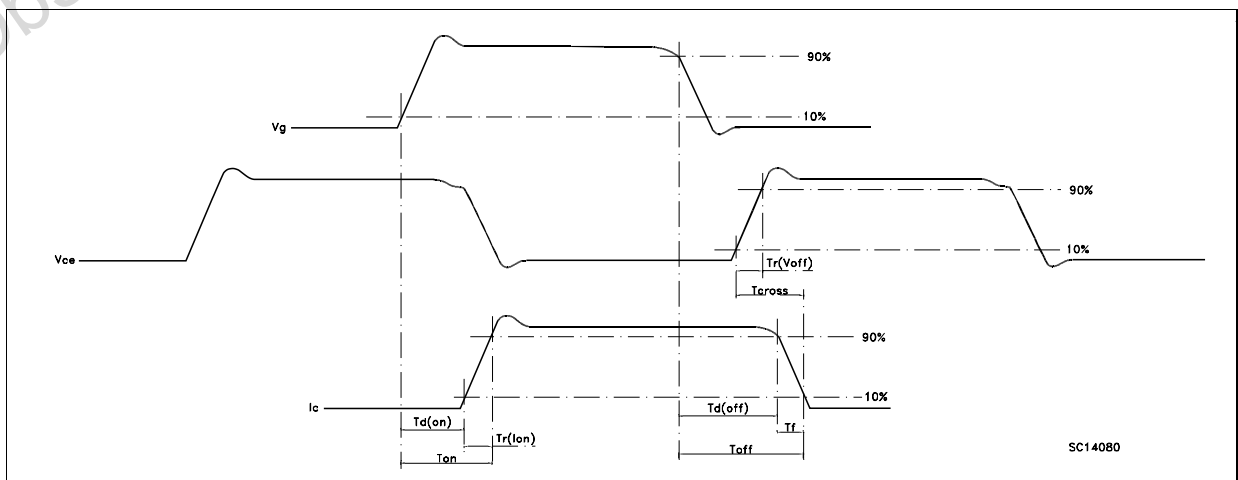
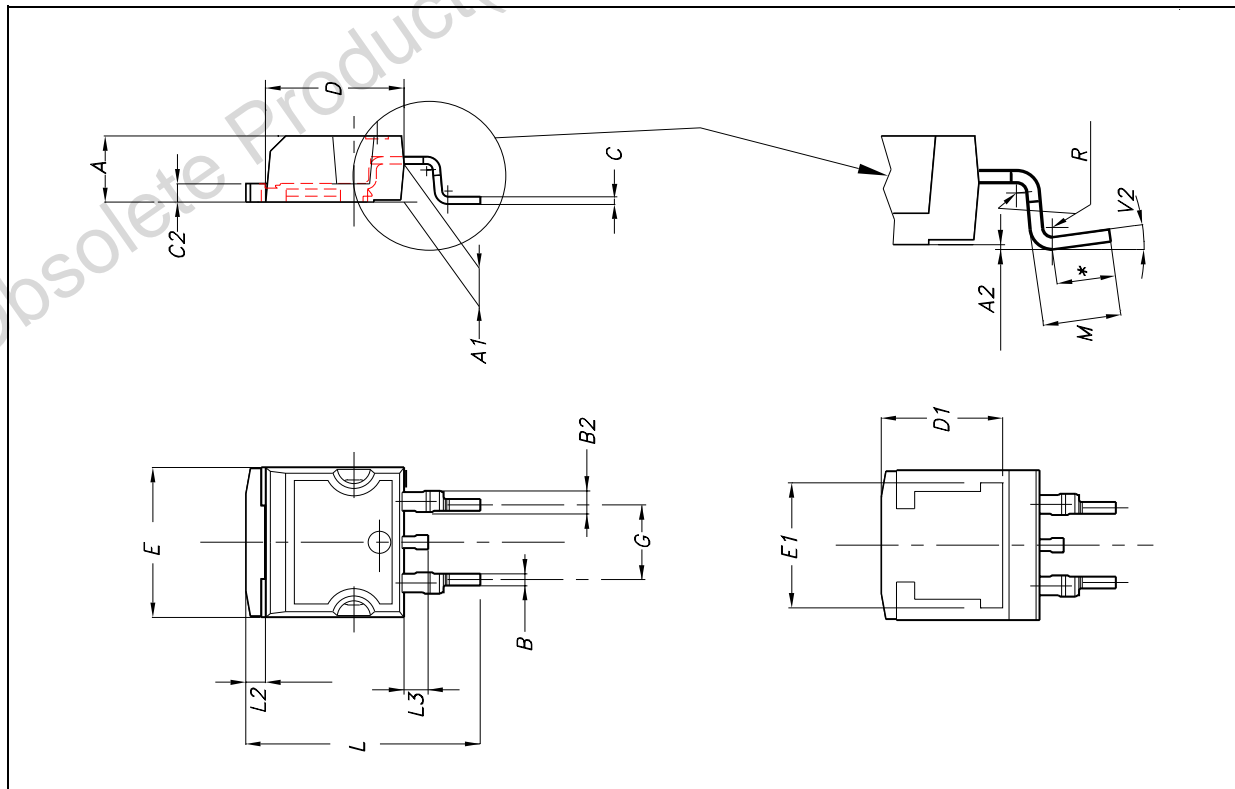

Fig. 3: Switching Waveforms



D<sup>2</sup>PAK MECHANICAL DATA

DIM.	mm.			inch		
	MIN.	TYP	MAX.	MIN.	TYP.	MAX.
A	4.4		4.6	0.173		0.181
A1	2.49		2.69	0.098		0.106
A2	0.03		0.23	0.001		0.009
B	0.7		0.93	0.027		0.036
B2	1.14		1.7	0.044		0.067
C	0.45		0.6	0.017		0.023
C2	1.23		1.36	0.048		0.053
D	8.95		9.35	0.352		0.368
D1		8			0.315	
E	10		10.4	0.393		
E1		8.5			0.334	
G	4.88		5.28	0.192		0.208
L	15		15.85	0.590		0.625
L2	1.27		1.4	0.050		0.055
L3	1.4		1.75	0.055		0.068
M	2.4		3.2	0.094		0.126
R		0.4			0.015	
V2	0°		8°			



Obsolete Product(s) - Obsolete Product(s)

Information furnished is believed to be accurate and reliable. However, STMicroelectronics assumes no responsibility for the consequences of use of such information nor for any infringement of patents or other rights of third parties which may result from its use. No license is granted by implication or otherwise under any patent or patent rights of STMicroelectronics. Specifications mentioned in this publication are subject to change without notice. This publication supersedes and replaces all information previously supplied. STMicroelectronics products are not authorized for use as critical components in life support devices or systems without express written approval of STMicroelectronics.

The ST logo is registered trademark of STMicroelectronics  
© 2000 STMicroelectronics - All Rights Reserved



All other names are the property of their respective owners.

STMicroelectronics GROUP OF COMPANIES  
Australia - Brazil - China - Finland - France - Germany - Hong Kong - India - Italy - Japan - Malaysia - Malta - Morocco -  
Singapore - Spain - Sweden - Switzerland - United Kingdom - U.S.A.

<http://www.st.com>

## Looking for pricing, stock, or lifecycle information?

Click below to explore more details on WIN SOURCE:

-  [View STGB3NB60SDT4](#) on WIN SOURCE
-  [STMicroelectronics](#) Information

## Optimize Your Supply Chain with WIN SOURCE Solutions

-  Global Sourcing Solution
-  Obsolete Management
-  Cost Control Management
-  Shortage Management
-  Alternative Solution
-  Excess Inventory Management