



THE DATASHEET OF BAT30CFILM



Small signal Schottky diodes

Datasheet - production data

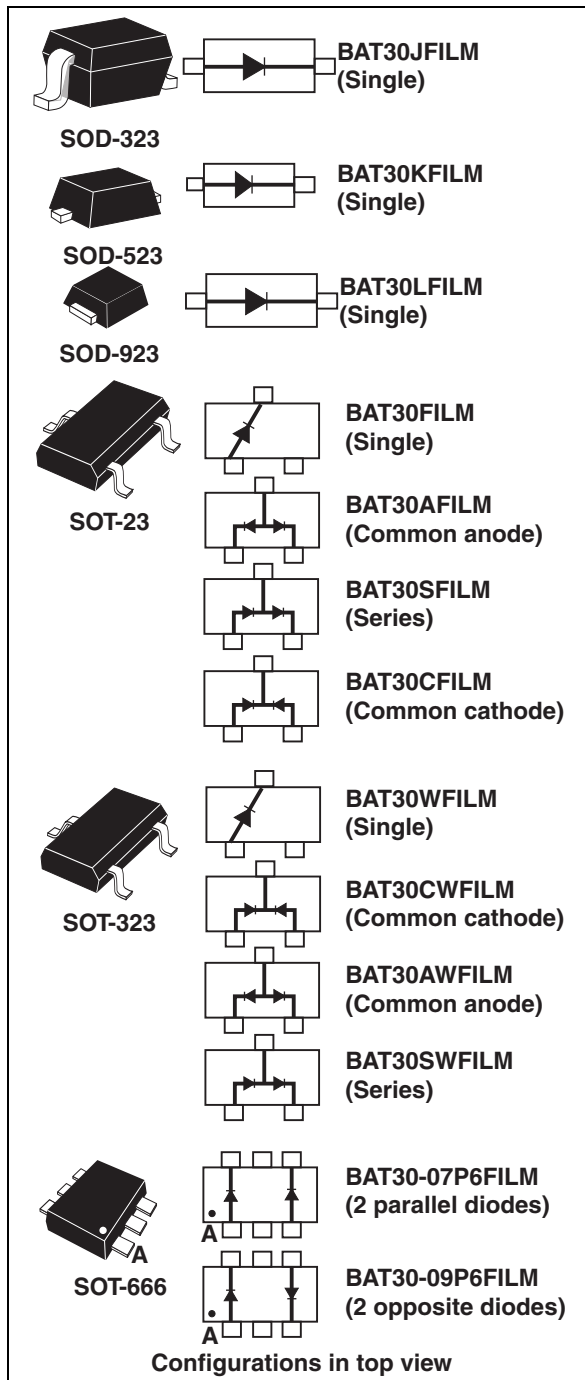

Features

- Very low conduction losses
- Negligible switching losses
- Low forward and reverse recovery times
- Extremely fast switching
- Surface mount device
- Low capacitance diode

Description

The BAT30 series uses 30 V Schottky barrier diodes encapsulated in a wide range of packages such as SOD-323, SOD-523, SOD-923, SOT-23, SOT-323, or SOT-666. This device is specially suited for switching mode applications needing low forward voltage drop diodes.

Table 1. Device summary

Symbol	Value
I_F	300 mA
V_{RRM}	30 V
$C(\text{typ})$	14 pF
$T_j(\text{max})$	150 °C

1 Characteristics

Table 2. Absolute ratings (limiting values at $T_j = 25^\circ\text{C}$, unless otherwise specified)

Symbol	Parameter	Value	Unit
V_{RRM}	Repetitive peak reverse voltage	30	V
I_F	Continuous forward current	300	mA
I_{FSM}	Surge non repetitive forward current	$t_p = 10\text{ ms}$ Sinusoidal	A
T_{stg}	Storage temperature range	-65 to +150	$^\circ\text{C}$
T_j	Maximum operating junction temperature	150	$^\circ\text{C}$
T_L	Maximum soldering temperature	260	$^\circ\text{C}$

Table 3. Thermal parameters

Symbol	Parameter	Value	Unit
$R_{th(j-a)}$	Junction to ambient ⁽¹⁾	SOT-23	500
		SOT-323, SOD-323, SOD-523, SOT-666	550
		SOD-523, SOT-666	600
		SOD-923	900
			$^\circ\text{C/W}$

1. On epoxy printed circuit board with recommended pad layout

Table 4. Static electrical characteristics

Symbol	Parameter	Test conditions	Min.	Typ.	Max.	Unit
$I_R^{(1)}$	Reverse leakage current	$T_j = 25^\circ\text{C}$	$V_R = 5\text{ V}$	-	-	0.5
			$V_R = 10\text{ V}$	-	-	1
			$V_R = 25\text{ V}$	-	0.65	3
			$V_R = 30\text{ V}$	-	-	5
		$T_j = 70^\circ\text{C}$	$V_R = 10\text{ V}$	-	7	20
$T_j = 85^\circ\text{C}$	-	18		50		
$V_F^{(2)}$	Forward voltage drop	$T_j = 25^\circ\text{C}$	$I_F = 0.1\text{ mA}$	-	-	240
			$I_F = 1\text{ mA}$	-	-	300
			$I_F = 10\text{ mA}$	-	-	375
			$I_F = 30\text{ mA}$	-	-	430
			$I_F = 100\text{ mA}$	-	-	500
			$I_F = 200\text{ mA}$	-	-	580
			$I_F = 300\text{ mA}$	-	530	-
						mV

1. Pulse test: $t_p = 5\text{ ms}$, $\delta < 2\%$

2. Pulse test: $t_p = 380\text{ }\mu\text{s}$, $\delta < 2\%$

Table 5. Dynamic characteristics

Symbol	Parameter	Test conditions	Min.	Typ	Max.	Unit
C	Diode capacitance	$V_R = 0\text{ V}, F = 1\text{ MHz}$	-	22	-	pF
		$V_R = 1\text{ V}, F = 1\text{ MHz}$	-	14	-	
		$V_R = 10\text{ V}, F = 1\text{ MHz}$	-	6	-	

Figure 1. Power dissipation versus average forward current

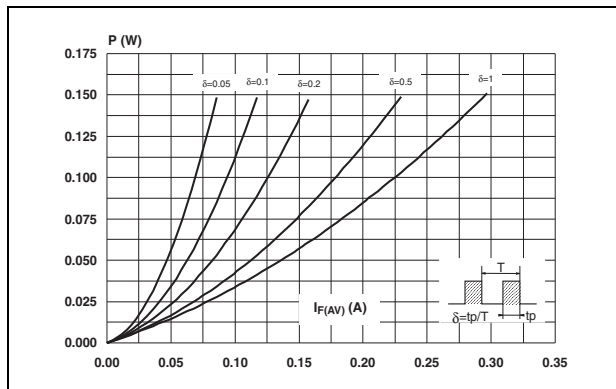

Figure 2. Average forward current versus ambient temperature (delta = 1)

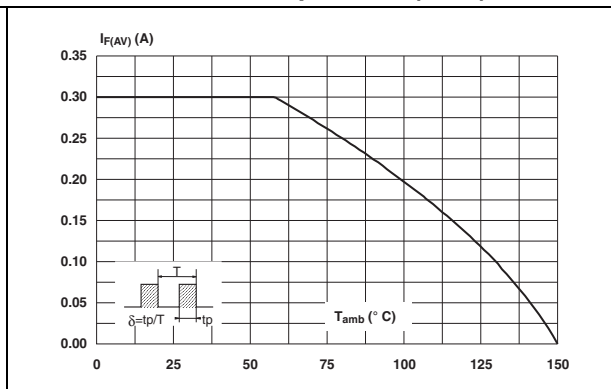

Figure 3. Relative variation of thermal impedance junction to ambient versus pulse duration

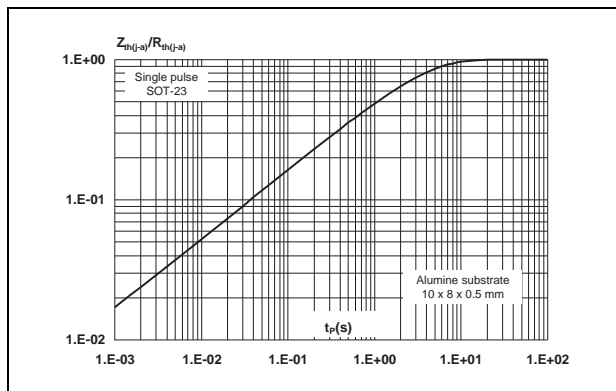

Figure 4. Relative variation of thermal impedance junction to ambient versus pulse duration

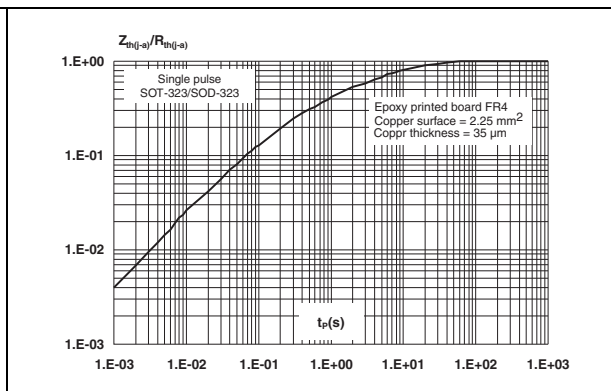

Figure 5. Relative variation of thermal impedance junction to ambient versus pulse duration

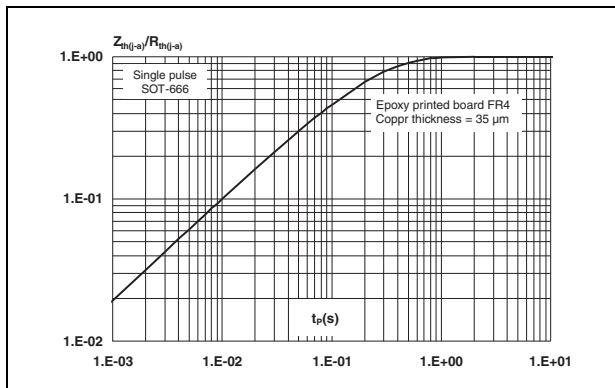

Figure 6. Relative variation of thermal impedance junction to ambient versus pulse duration

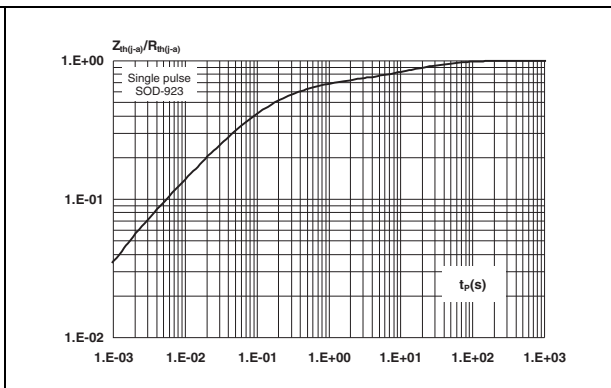

Figure 7. Relative variation of thermal impedance junction to ambient versus pulse duration

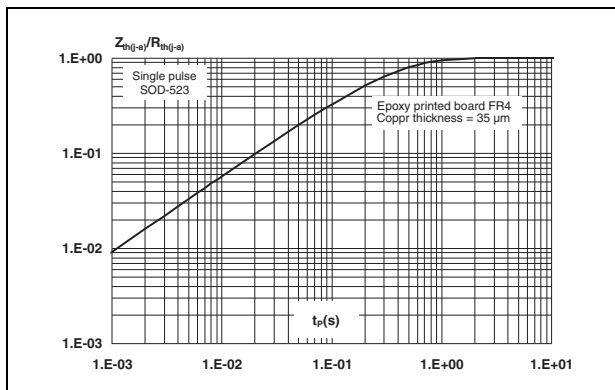

Figure 8. Thermal resistance junction to ambient versus copper surface under each lead (SOD-923)

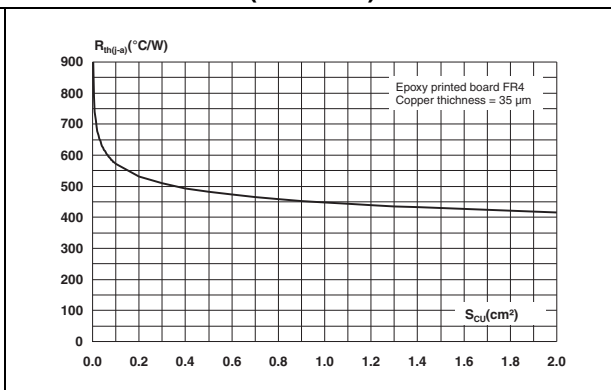

Figure 9. Thermal resistance junction to ambient versus copper surface under each lead (SOD-323)

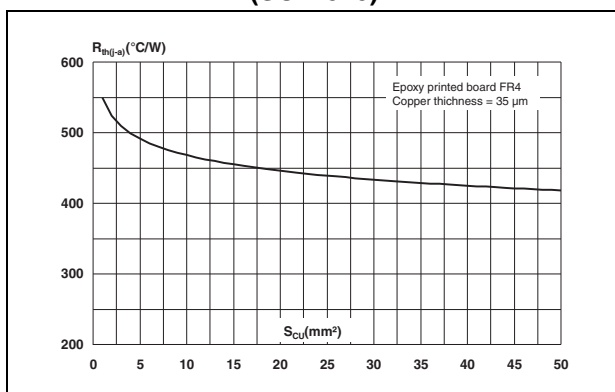

Figure 10. Leakage current versus reverse applied voltage (typical values)

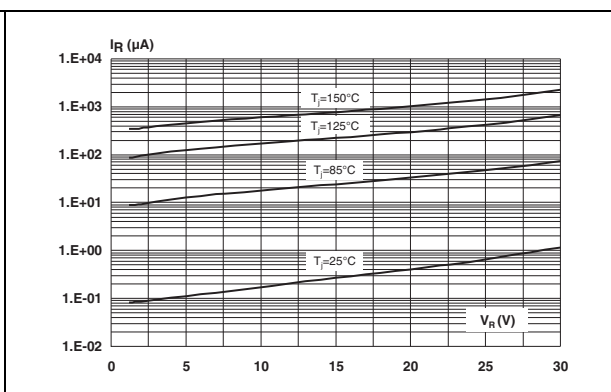

Figure 11. Relative variation of reverse leakage current versus junction temperature (typical values)

Figure 12. Junction capacitance versus reverse applied voltage (typical values)

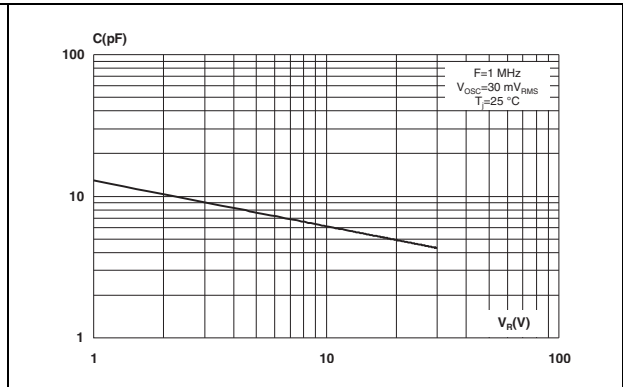
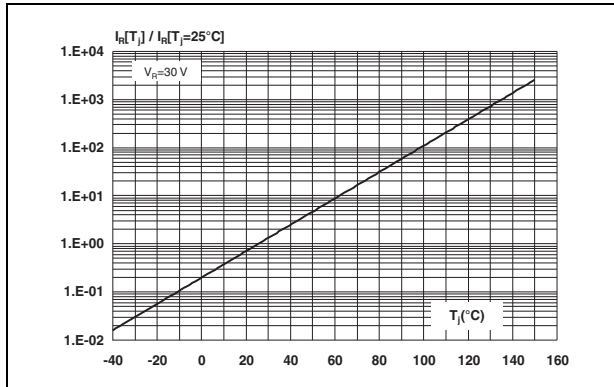
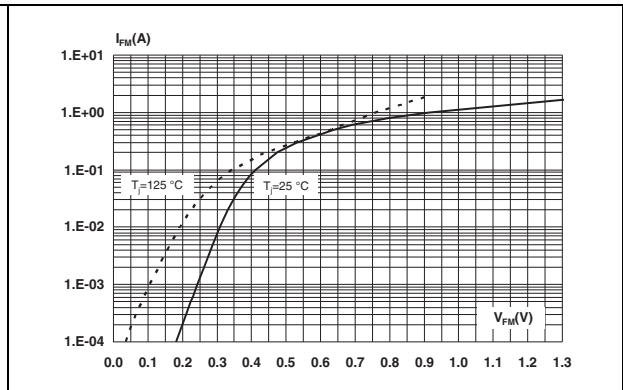
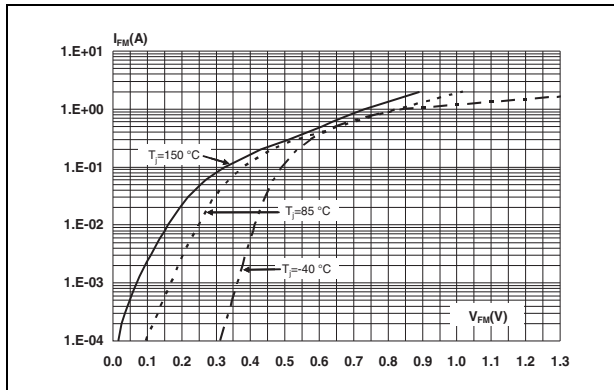

Figure 13. Forward voltage drop versus forward current (typical values)

Figure 14. Forward voltage drop versus forward current (typical values)



2 Ordering information scheme

Figure 15. Ordering information scheme

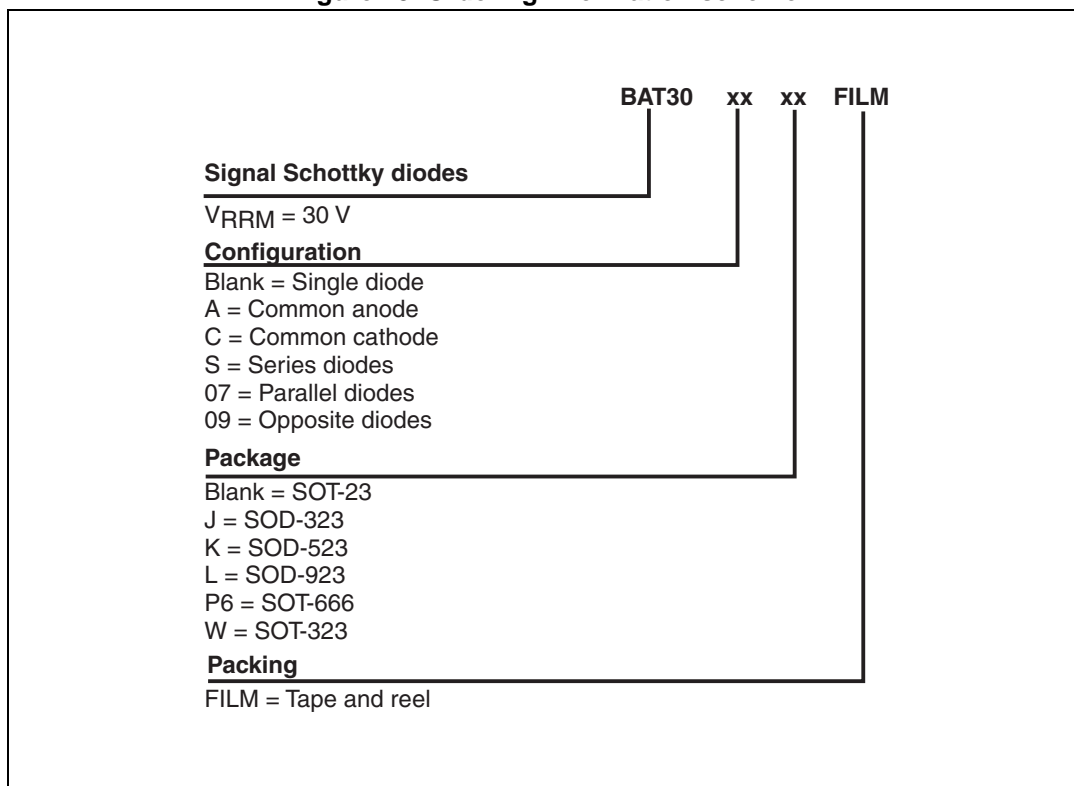

3 Package information

- Epoxy meets UL94, V0
- Lead-free packages

In order to meet environmental requirements, ST offers these devices in different grades of ECOPACK® packages, depending on their level of environmental compliance. ECOPACK® specifications, grade definitions and product status are available at: www.st.com. ECOPACK® is an ST trademark.

Table 6. SOD-323 dimensions

Ref.	Dimensions			
	Millimeters		Inches	
	Min.	Max.	Min.	Max.
A	-	1.17	-	0.046
A1	0	0.1	0	0.004
b	0.25	0.44	0.01	0.017
c	0.1	0.25	0.004	0.01
D	1.52	1.8	0.06	0.071
E	1.11	1.45	0.044	0.057
H	2.3	2.7	0.09	0.106
L	0.1	0.46	0.004	0.02
Q1	0.1	0.41	0.004	0.016

Figure 16. SOD-323 footprint (dimensions in mm)

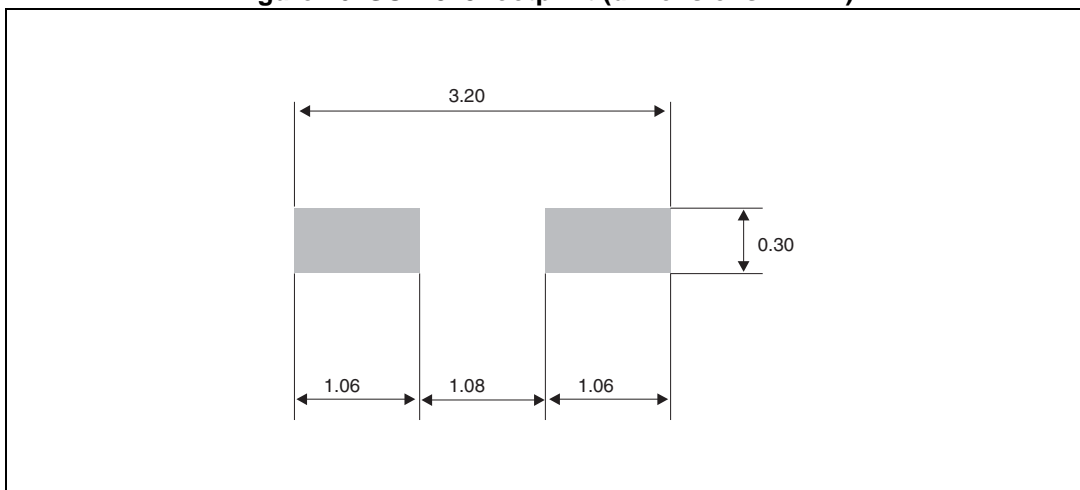

Table 7. SOD-523 dimensions

Ref.	Dimensions					
	Millimeters			Inches		
	Min.	Typ.	Max.	Min.	Typ.	Max.
A	0.50	0.60	0.70	0.020	0.024	0.028
E	1.50	1.60	1.70	0.059	0.063	0.067
E1	1.10	1.20	1.30	0.043	0.047	0.051
D	0.70	0.80	0.90	0.028	0.031	0.035
b	0.25	-	0.35	0.010	-	0.014
c	0.07	-	0.20	0.003	-	0.008
L	0.15	0.20	0.25	0.006	0.008	0.010
L1	0.05	-	0.20	0.002	-	0.008

Figure 17. SOD-523 footprint (dimensions in mm)

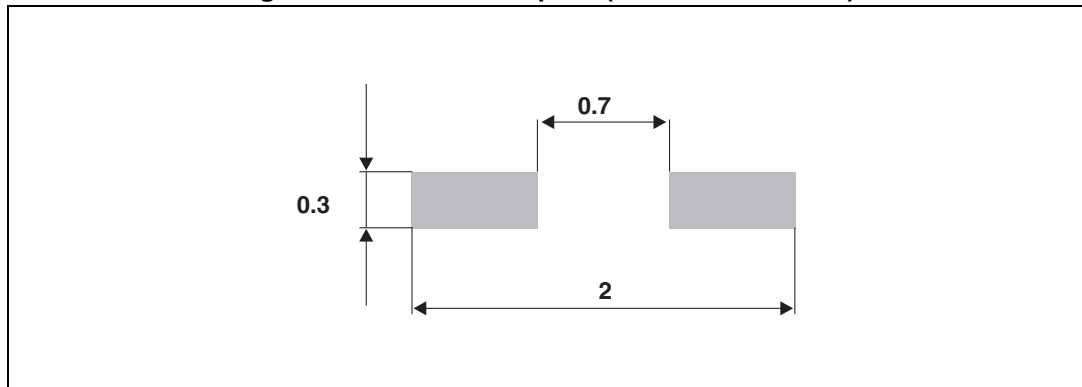

Table 8. SOD-923 dimensions

Ref.	Dimensions					
	Millimeters			Inches		
	Min.	Typ.	Max.	Min.	Typ.	Max.
A			0.40			0.016
b	0.25	0.30	0.35	0.010	0.012	0.014
c	0.08	0.145	0.21	0.003	0.006	0.008
D	0.55	0.60	0.65	0.022	0.024	0.026
E	0.95	1.00	1.05	0.037	0.039	0.041
E1	0.75	0.825	0.90	0.030	0.032	0.035
L	-	-	0.20	-	-	0.008

Figure 18. SOD-923 footprint (dimensions in mm)

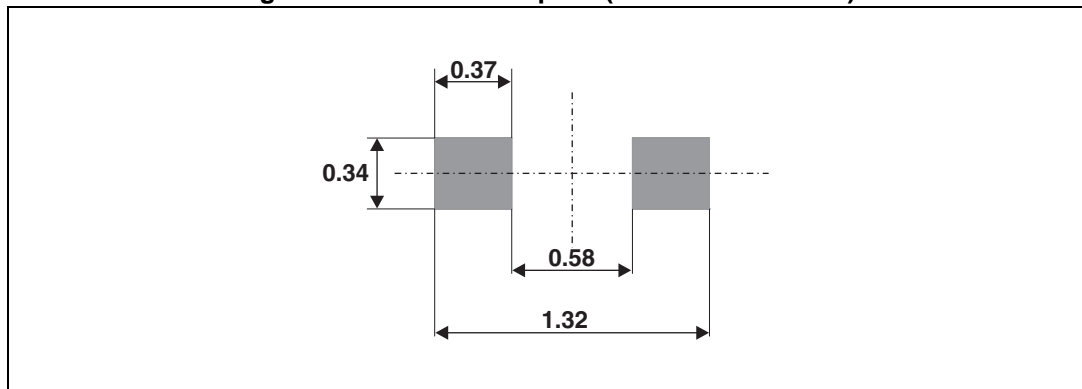

Table 9. SOT-23 dimensions

Ref.	Dimensions			
	Millimeters		Inches	
	Min.	Max.	Min.	Max.
A	0.89	1.4	0.035	0.055
A1	0	0.1	0	0.004
B	0.3	0.51	0.012	0.02
c	0.085	0.18	0.003	0.007
D	2.75	3.04	0.108	0.12
e	0.85	1.05	0.033	0.041
e1	1.7	2.1	0.067	0.083
E	1.2	1.6	0.047	0.063
H	2.1	2.75	0.083	0.108
L	0.6 typ.		0.024 typ.	
S	0.35	0.65	0.014	0.026

Figure 19. SOT-23 footprint (dimensions in mm)

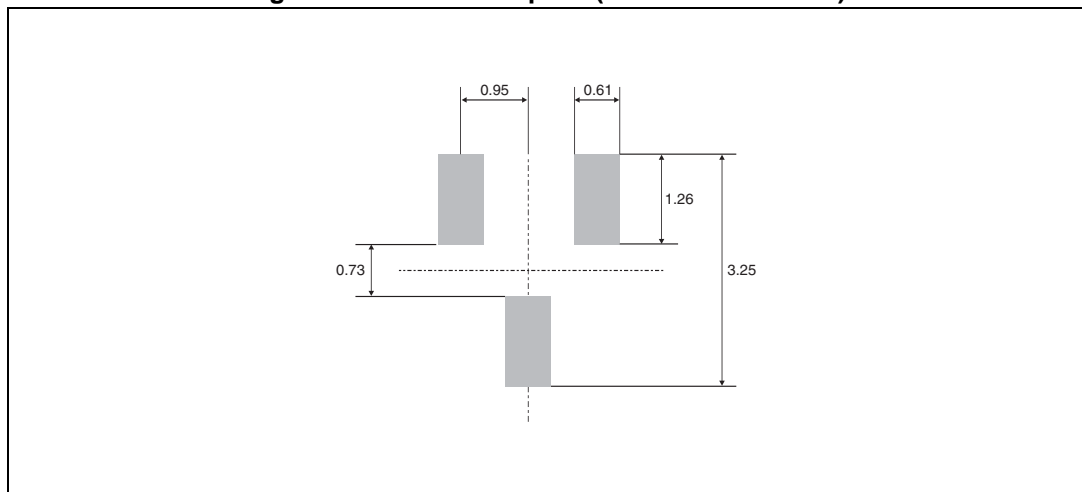
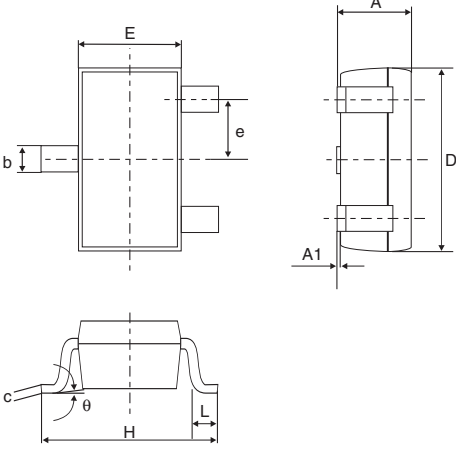

Table 10. SOT-323 dimensions



Ref.	Dimensions					
	Millimeters			Inches		
	Min.	Typ.	Max.	Min.	Typ.	Max.
A	0.8	-	1.1	0.031	-	0.043
A1	0.0	-	0.1	0.0	-	0.004
b	0.25	-	0.4	0.010	-	0.016
c	0.1	-	0.26	0.004	-	0.010
D	1.8	2.0	2.2	0.071	0.079	0.086
E	1.15	1.25	1.35	0.045	0.049	0.053
e	-	0.65	-	-	0.026	-
H	1.8	2.1	2.4	0.071	0.083	0.094
L	0.1	0.2	0.3	0.004	0.008	0.012
q	0	-	30°	0	-	30°

Figure 20. SOT-323 footprint (dimensions in mm)

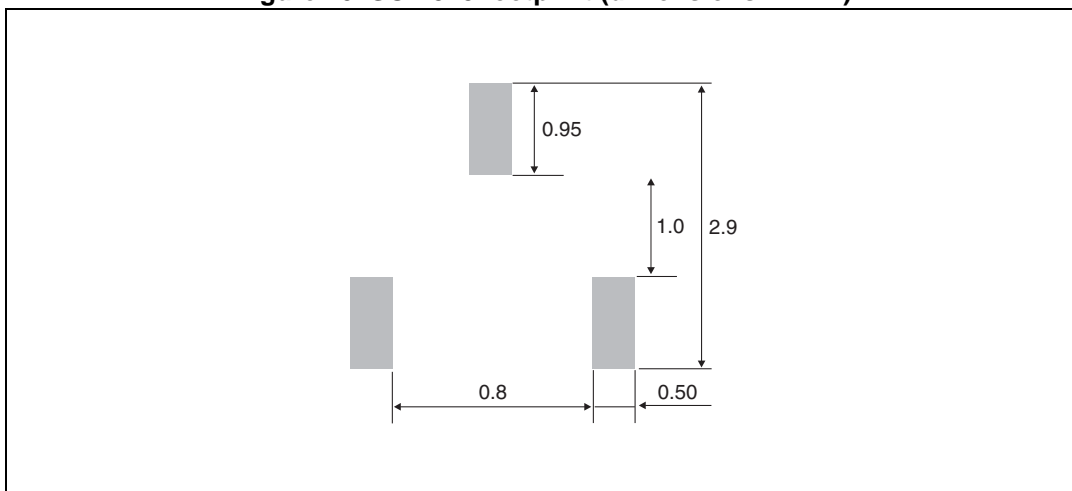
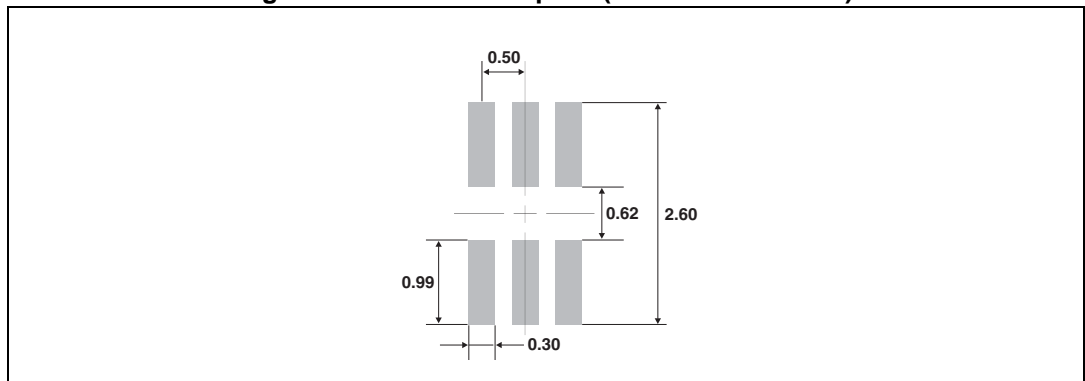

Table 11. SOT-666 dimensions

Ref.	Dimensions					
	Millimeters			Inches		
	Min.	Typ.	Max.	Min.	Typ.	Max.
A	0.45	-	0.60	0.018	-	0.024
A3	0.08	-	0.18	0.003	-	0.007
b	0.17	-	0.34	0.007	-	0.013
b1	0.19	0.27	0.34	0.007	0.011	0.013
D	1.50	-	1.70	0.059	-	0.067
E	1.50	-	1.70	0.059	-	0.067
E1	1.10	-	1.30	0.043	-	0.051
e	-	0.50	-	-	0.020	-
L1	-	0.19	-	-	0.007	-
L2	0.10		0.30	0.004		0.012
L3	-	0.10	-	-	0.004	-

Figure 21. SOT-666 footprint (dimensions in mm)



4 Ordering information

Table 12. Ordering information

Order code	Marking	Package	Weight	Base qty	Packing mode
BAT30-07P6FILM	P3	SOT-666 Parallel	2.9 mg	5000	Tape and reel
BAT30-09P6FILM	Q3	SOT-666 Opposite	2.9 mg	5000	Tape and reel
BAT30AFILM	A30	SOT-23 Common anode	10 mg	3000	Tape and reel
BAT30AWFILM	A30	SOT-323 Common anode	6 mg	3000	Tape and reel
BAT30CFILM	C30	SOT-23 Common cathode	10 mg	3000	Tape and reel
BAT30CWFILM	C30	SOT-323 Common cathode	6 mg	3000	Tape and reel
BAT30FILM	B30	SOT-23 Single	10 mg	3000	Tape and reel
BAT30JFILM	30	SOD-323 Single	5 mg	3000	Tape and reel
BAT30KFILM	30	SOD-523 Single	1.4 mg	3000	Tape and reel
BAT30LFILM	31	SOD-923 Single	0.56 mg	10000	Tape and reel
BAT30SFILM	S30	SOT-23 Serial	10 mg	3000	Tape and reel
BAT30SWFILM	S30	SOT-323 Serial	6 mg	3000	Tape and reel
BAT30WFILM	B30	SOT-323 Single	6 mg	3000	Tape and reel

5 Revision history

Table 13. Document revision history

Date	Revision	Changes
24-Jul-2006	1	First issue
08-Jul-2009	2	Added SOD-923 package. Table 12 sorted on alphabetic sequence of order code. Updated ECOPACK statement.
13-Oct-2009	3	Updated Table 7 quote "L1" from 0.10 to 0.05.
01-Apr-2014	4	Added Pin 1 anode marker to SOT-666 package graphics. Updated Table 2: Absolute ratings (limiting values at $T_j = 25^\circ\text{C}$, unless otherwise specified) .

Please Read Carefully:

Information in this document is provided solely in connection with ST products. STMicroelectronics NV and its subsidiaries ("ST") reserve the right to make changes, corrections, modifications or improvements, to this document, and the products and services described herein at any time, without notice.

All ST products are sold pursuant to ST's terms and conditions of sale.

Purchasers are solely responsible for the choice, selection and use of the ST products and services described herein, and ST assumes no liability whatsoever relating to the choice, selection or use of the ST products and services described herein.

No license, express or implied, by estoppel or otherwise, to any intellectual property rights is granted under this document. If any part of this document refers to any third party products or services it shall not be deemed a license grant by ST for the use of such third party products or services, or any intellectual property contained therein or considered as a warranty covering the use in any manner whatsoever of such third party products or services or any intellectual property contained therein.

UNLESS OTHERWISE SET FORTH IN ST'S TERMS AND CONDITIONS OF SALE ST DISCLAIMS ANY EXPRESS OR IMPLIED WARRANTY WITH RESPECT TO THE USE AND/OR SALE OF ST PRODUCTS INCLUDING WITHOUT LIMITATION IMPLIED WARRANTIES OF MERCHANTABILITY, FITNESS FOR A PARTICULAR PURPOSE (AND THEIR EQUIVALENTS UNDER THE LAWS OF ANY JURISDICTION), OR INFRINGEMENT OF ANY PATENT, COPYRIGHT OR OTHER INTELLECTUAL PROPERTY RIGHT.

ST PRODUCTS ARE NOT DESIGNED OR AUTHORIZED FOR USE IN: (A) SAFETY CRITICAL APPLICATIONS SUCH AS LIFE SUPPORTING, ACTIVE IMPLANTED DEVICES OR SYSTEMS WITH PRODUCT FUNCTIONAL SAFETY REQUIREMENTS; (B) AERONAUTIC APPLICATIONS; (C) AUTOMOTIVE APPLICATIONS OR ENVIRONMENTS, AND/OR (D) AEROSPACE APPLICATIONS OR ENVIRONMENTS. WHERE ST PRODUCTS ARE NOT DESIGNED FOR SUCH USE, THE PURCHASER SHALL USE PRODUCTS AT PURCHASER'S SOLE RISK, EVEN IF ST HAS BEEN INFORMED IN WRITING OF SUCH USAGE, UNLESS A PRODUCT IS EXPRESSLY DESIGNATED BY ST AS BEING INTENDED FOR "AUTOMOTIVE, AUTOMOTIVE SAFETY OR MEDICAL" INDUSTRY DOMAINS ACCORDING TO ST PRODUCT DESIGN SPECIFICATIONS. PRODUCTS FORMALLY ESCC, QML OR JAN QUALIFIED ARE DEEMED SUITABLE FOR USE IN AEROSPACE BY THE CORRESPONDING GOVERNMENTAL AGENCY.

Resale of ST products with provisions different from the statements and/or technical features set forth in this document shall immediately void any warranty granted by ST for the ST product or service described herein and shall not create or extend in any manner whatsoever, any liability of ST.

ST and the ST logo are trademarks or registered trademarks of ST in various countries.

Information in this document supersedes and replaces all information previously supplied.

The ST logo is a registered trademark of STMicroelectronics. All other names are the property of their respective owners.

© 2014 STMicroelectronics - All rights reserved

STMicroelectronics group of companies

Australia - Belgium - Brazil - Canada - China - Czech Republic - Finland - France - Germany - Hong Kong - India - Israel - Italy - Japan - Malaysia - Malta - Morocco - Philippines - Singapore - Spain - Sweden - Switzerland - United Kingdom - United States of America

www.st.com

Looking for pricing, stock, or lifecycle information?

Click below to explore more details on WIN SOURCE:

- ⊖ [View BAT30CFILM on WIN SOURCE](#)
- ⊖ [STMicroelectronics Information](#)

Optimize Your Supply Chain with WIN SOURCE Solutions

- ✓ Global Sourcing Solution
- ✓ Obsolete Management
- ✓ Cost Control Management
- ✓ Shortage Management
- ✓ Alternative Solution
- ✓ Excess Inventory Management