



**THE DATASHEET OF
ACPM-7331-TR1**



ACPM-7331-TR1

UMTS1900 4x4 Power Amplifier (1850-1910MHz)



Data Sheet

Description

The ACPM-7331, a Wide-band Code Division Multiple Access(WCDMA) Power Amplifier (PA), is a fully matched 10-pin surface mount module developed for WCDMA handset applications. This power amplifier module is developed to cover 1850-1910MHz bandwidth. The ACPM-7331 meets the stringent WCDMA linearity requirements for output power of up to 28.5dBm. The ACPM-7331 is also developed to meet HSDPA specs.

The ACPM-7331 is designed to enhance the efficiency at low and medium output power range by using 3-mode control scheme with 2 mode control pins. This provides extended talk time.

The ACPM-7331 is self contained, incorporating 50ohm input and output matching networks.

Features

- Excellent Linearity
- Low quiescent current
- High Efficiency
 PAE at 28.5dBm: 33.2%
 PAE at 16dBm: 16.1%
 PAE at 8dBm: 6%
- 10-pin surface mounting package
 4mmx4mmx1.1mm(typ)
- Internal 50ohm matching networks for both RF input and output
- RoHS Compliant

Order information

Part Number	No. of Devices	Container
ACPM-7331-TR1	1000	7" Tape and Reel
ACPM-7331-BLKR	100	BULK

Applications

- WCDMA Handset (HSDPA)

Functional Block Diagram

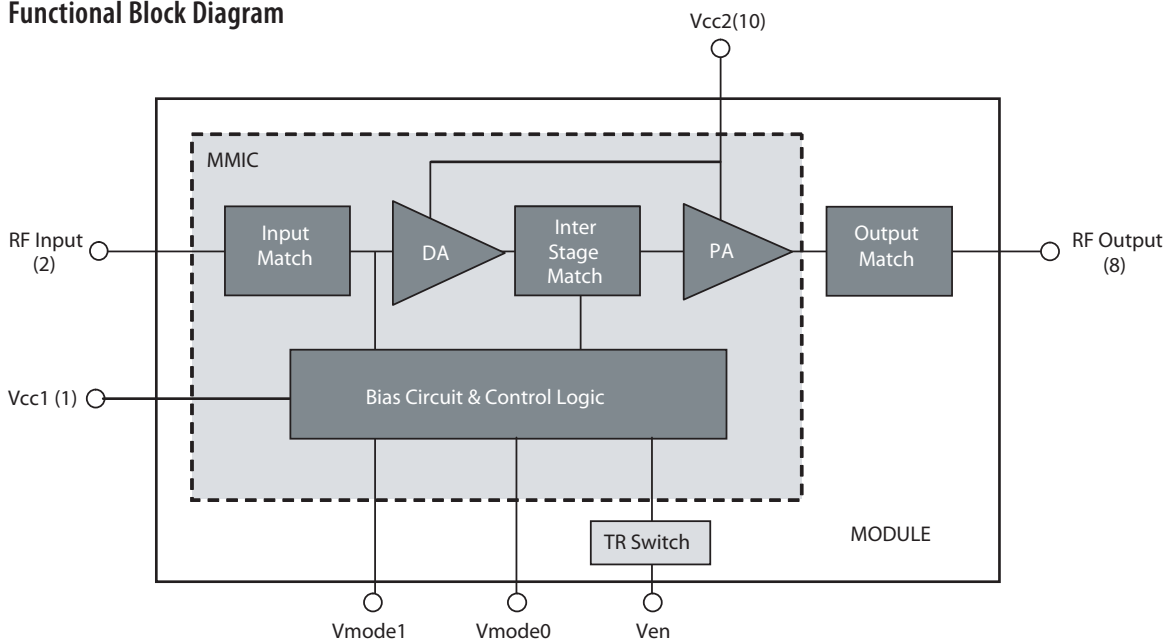

Table 1. Absolute Maximum Ratings ^[1]

Parameter	Symbol	Min	Nominal	Max	Unit
RF Input Power	Pin	–	–	10.0	dBm
DC Supply Voltage	Vcc	0	3.4	5.0	V
Enable Voltage	Ven	0	2.6	3.3	V
Mode Control Voltage	Vmode0	0	2.6	3.3	V
	Vmode1	0	2.6	3.3	V
Storage Temperature	Tstg	-55	–	+125	°C

Table 2. Recommended Operating Condition

Parameter	Symbol	Min	Nominal	Max	Unit
DC Supply Voltage	Vcc	3.2	3.4	4.2	V
PA Enable (Ven)	Low	0	0	0.5	V
	High	1.9	2.6	2.9	V
Mode Control Voltage – Vmode0	Low	0	0	0.5	V
	High	1.9	2.6	2.9	V
– Vmode1	Low	0	0	0.5	V
	High	1.9	2.6	2.9	V
Operating Frequency	Fo	1850		1910	MHz
Ambient Temperature	Ta	-20	25	90	°C

Table 3. Power Range Truth Table

Power Mode	Symbol	Ven	Vmode0	Vmode1	Range
High Power Mode	PR3	High	Low	Low	~ 28.5dBm
Mid Power Mode	PR2	High	High	Low	~ 16dBm
Low Power Mode	PR1	High	High	High	~ 8dBm
Shut Down Mode	–	Low	–	-	–

Notes:

1. No damage assuming only one parameter is set at limit at a time with all other parameters set at or below nominal value.

Table 4. Electrical Characteristics for WCDMA Mode (Vcc=3.4V, Ven=2.6V, T=25°C, Zin/Zout=50ohm)^[1]

Characteristics	Symbol	Condition	Min.	Typ.	Max.	Unit
Operating Frequency Range	F		1850	–	1910	MHz
Gain	Gain_hi	High Power Mode, Pout=28.5dBm	23.5	27		dB
	Gain_mid	Mid Power Mode, Pout=16dBm	13	16.5		dB
	Gain_low	Low Power Mode, Pout=8dBm	12	15		dB
Power Added Efficiency	PAE_hi	High Power Mode, Pout=28.5dBm	29.9	33.2		%
	PAE_mid	Mid Power Mode, Pout=16dBm	11.8	16.1		%
	PAE_low	Low Power Mode, Pout=8dBm	4.1	6		%
Total Supply Current	Icc_hi	High Power Mode, Pout=28.5dBm		625	695	mA
	Icc_mid	Mid Power Mode, Pout=16dBm		71	97	mA
	Icc_low	Low Power Mode, Pout=8dBm		30	44	mA
Quiescent Current	Iq_hi	High Power Mode		96	120	mA
	Iq_mid	Mid Power Mode		20	26	mA
	Iq_low	Low Power Mode		14	18	mA
Enable Current	Ien_hi	High Power Mode		0.18	1	mA
	Ien_mid	Mid Power Mode		0.18	1	mA
	Ien_low	Low Power Mode		0.18	1	mA
Control Current	Imode0_mid	Mid Power Mode		0.4	1	mA
	Imode1_low	Low Power Mode		0.18	1	mA
	Imode0_low	Low Power Mode		0.4	1	mA
Total Current in Power-down mode	Ipd	Ven=0V		0.2	5	µA
Adjacent Channel Leakage Ratio [2]	5 MHz offset	ACL1_hi	High Power Mode, Pout=28.5 dBm	-40	-37	dBc
		ACL2_hi		-56	-46	dBc
	10 MHz offset	ACL1_mid	Mid Power Mode, Pout=16.0 dBm	-43	-36	dBc
		ACL2_mid		-58	-46	dBc
	5 MHz offset	ACL1_low	Low Power Mode, Pout=8.0 dBm	-44	-37	dBc
		ACL2_low		-58	-46	dBc
Harmonic Sup- pression	Second	2f0	High Power Mode, Pout=28.5 dBm	-37	-30	dBc
	Third	3f0		-70	-50	dBc
Input VSWR	VSWR			1.7:1	2.2:1	
Stability (Spurious Output)	S	VSWR 6:1, All phase			-60	dBc
Noise Power in Rx Band	RxBN	High Power Mode, Pout=28.5 dBm		-136	-133	dBm/Hz
Phase Discontinuity	PDlow_mid	low power mode ↔ mid power mode, at Pout=8dBm			10	deg
	PDmid_high	mid power mode ↔ high power mode, at Pout=16dBm			15	deg
Ruggedness	Ru	Pout<28.5dBm, Pin<10dBm, All phase High Power Mode			10:1	VSWR

Notes:

1. Electrical characteristics are specified under WCDMA modulated (3GPP Uplink DPCCH + 1DPDCH) signal
2. ACP is expressed as a ratio of total adjacent power to signal power, both with 3.84MHz bandwidth at specified offsets.

Table 5. Electrical Characteristics for HSDPA Mode (Vcc=3.4V, Ven=2.6V, T=25°C, Zin/Zout=50ohm)^[1]

Characteristics	Symbol	Condition	Min.	Typ.	Max.	Unit	
Operating Frequency Range	F		1850	–	1910	MHz	
Gain	Gain_hih	High Power Mode, Pout=28.5 dBm	23.5	27		dB	
	Gain_midh	Mid Power Mode, Pout=16.0 dBm	13	16.5		dB	
	Gain_lowh	Low Power Mode, Pout=8.0 dBm	12	15		dB	
Power Added Efficiency	PAE_hih	High Power Mode, Pout=28.5 dBm	30.3	34.1		%	
	PAE_midh	Mid Power Mode, Pout=16.0 dBm	11.8	16.4		%	
	PAE_lowh	Low Power Mode, Pout=8.0 dBm	4.1	6		%	
Total Supply Current	icc_hih	High Power Mode, Pout=28.5 dBm		610	685	mA	
	icc_midh	Mid Power Mode, Pout=16.0 dBm		70	97	mA	
	icc_lowh	Low Power Mode, Pout=8.0 dBm		30	44	mA	
Adjacent Channel Leakage Ratio ^[2]	5 MHz offset	ACL1_hih	High Power Mode, Pout=28.5 dBm	–	–40	–37	dBc
		ACL2_hih			–55	–46	dBc
	10 MHz offset	ACL1_midh	Mid Power Mode, Pout=16.0 dBm	–	–42	–36	dBc
		ACL2_midh			–58	–46	dBc
	5 MHz offset	ACL1_lowh	Low Power Mode, Pout=8.0 dBm	–	–44	–37	dBc
		ACL2_lowh			–58	–46	dBc

Notes:

1. Electrical characteristics are specified under HSDPA modulated Up-Link signal (DPCCH/DPDCH=12/15, HS-DPCCH/DPDCH=15/15)
2. ACP is expressed as a ratio of total adjacent power to signal power, both with 3.84MHz bandwidth at specified offsets

Characteristics Data (WCDMA, $V_{cc}=3.4V$, $V_{en}=2.6V$, $T=25^{\circ}C$, $Z_{in}/Z_{out}=50\Omega$)

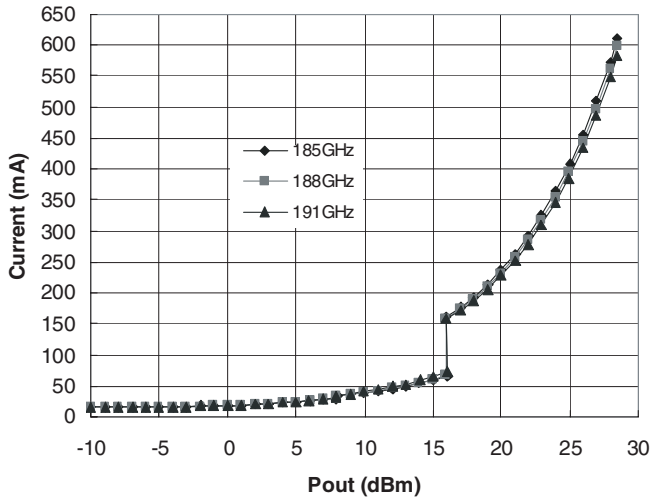

Figure 1. Total Current vs. Output Power

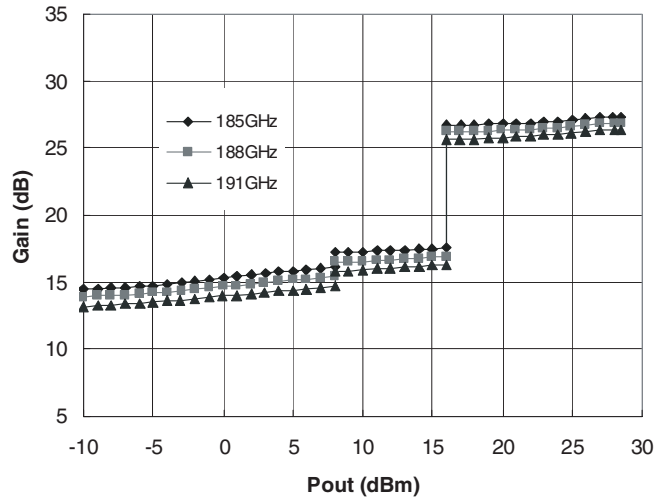

Figure 2. Gain vs. Output Power

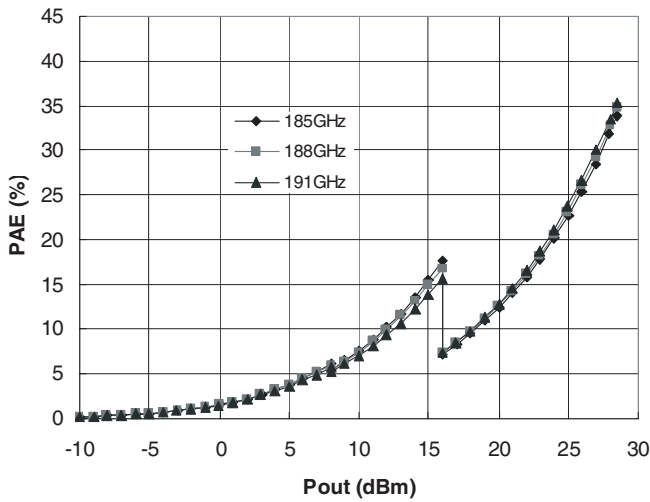

Figure 3. Power Added Efficiency vs. Output Power

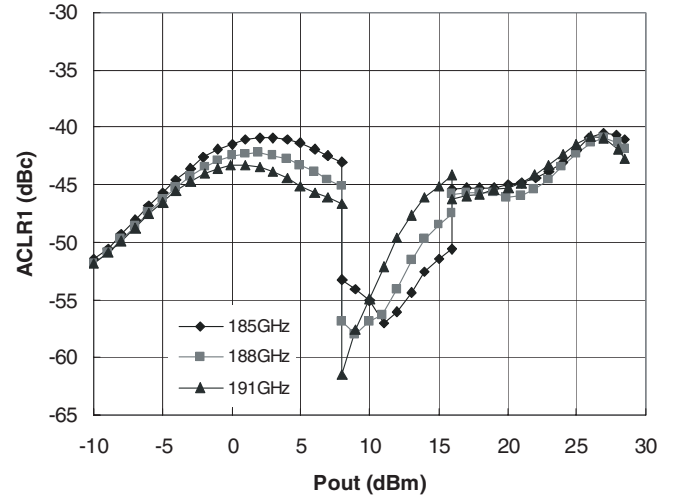

Figure 4. Adjacent Channel Leakage Ratio 1 vs. Output Power

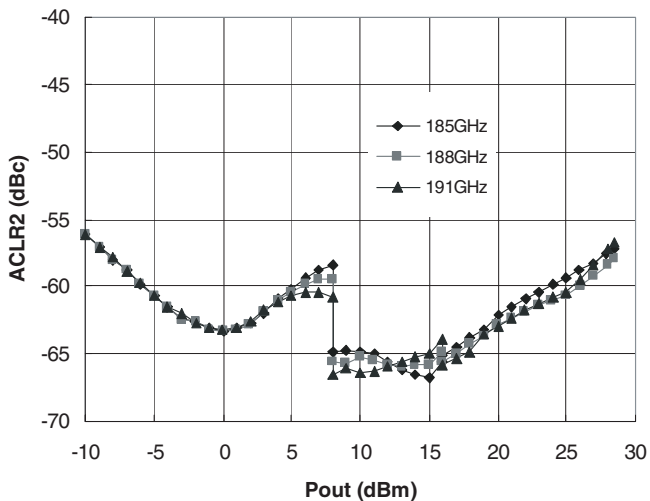

Figure 5. Adjacent Channel Leakage Ratio 2 vs. Output Power

Characteristics Data (HSDPA, $V_{cc}=3.4V$, $V_{en}=2.6V$, $T=25^{\circ}C$, $Z_{in}/Z_{out}=50\Omega$)

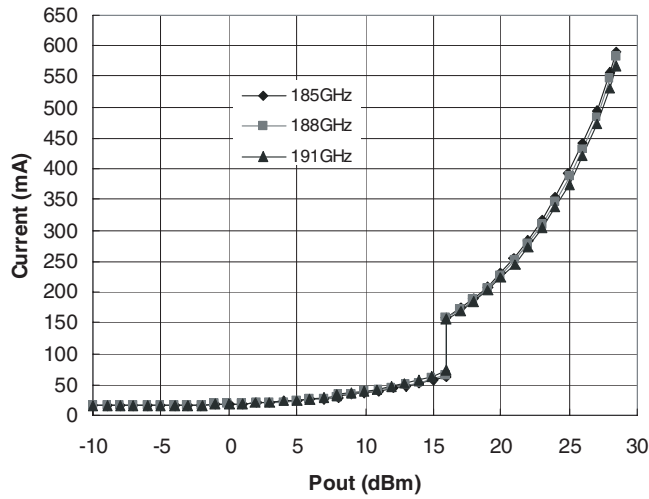

Figure 6. Total Current vs. Output Power

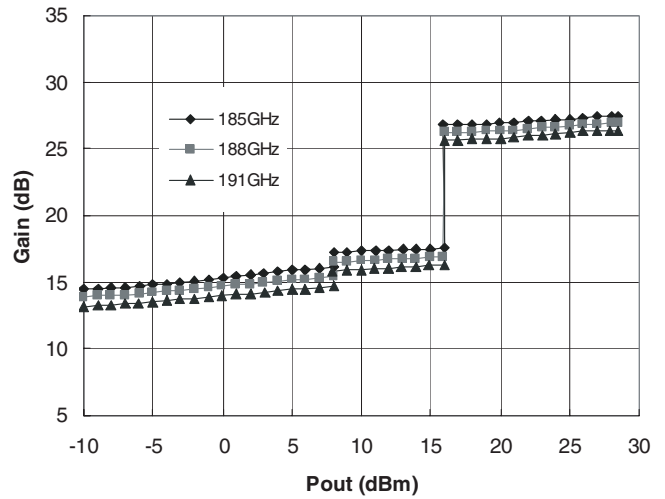

Figure 7. Gain vs. Output Power

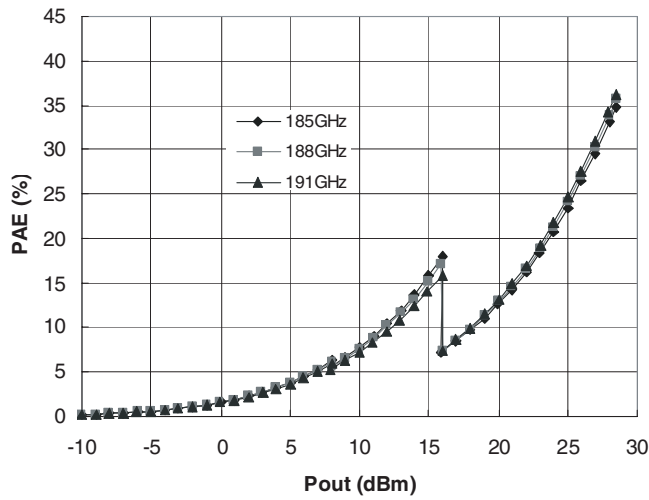

Figure 8. Power Added Efficiency vs. Output Power

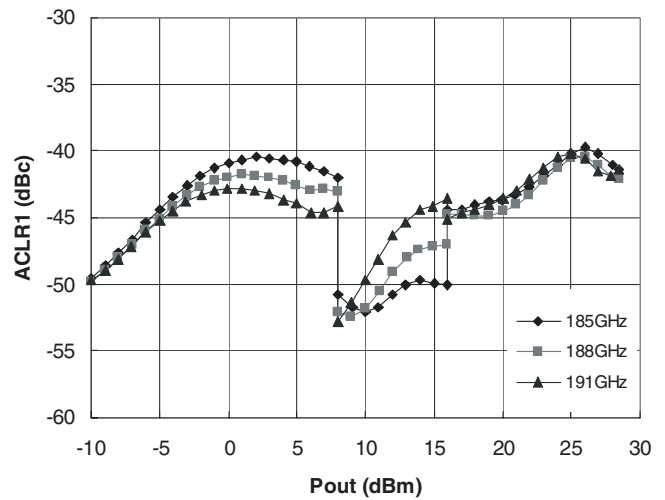

Figure 9. Adjacent Channel Leakage Ratio 1 vs. Output Power

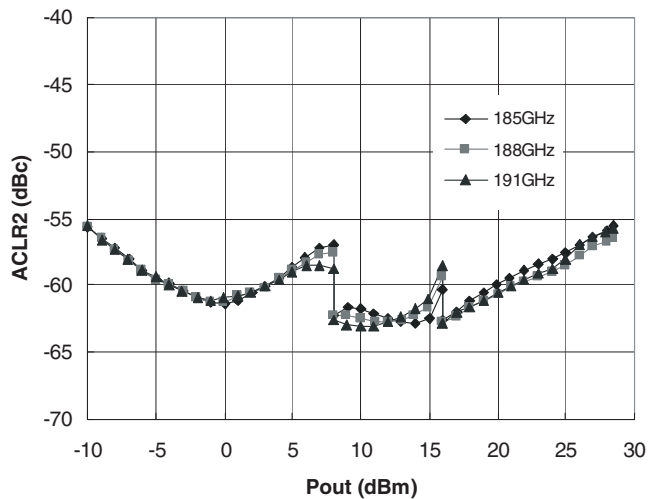

Figure 10. Adjacent Channel Leakage Ratio 2 vs. Output Power

Evaluation Board Description

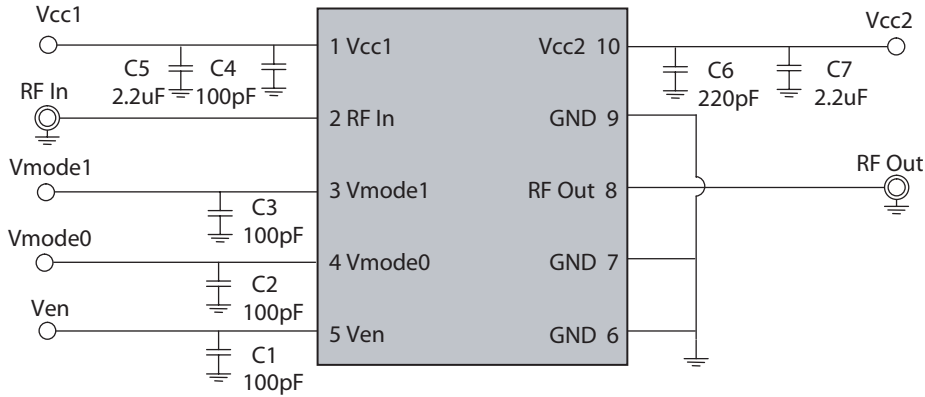

Figure 11. Evaluation Board Schematic

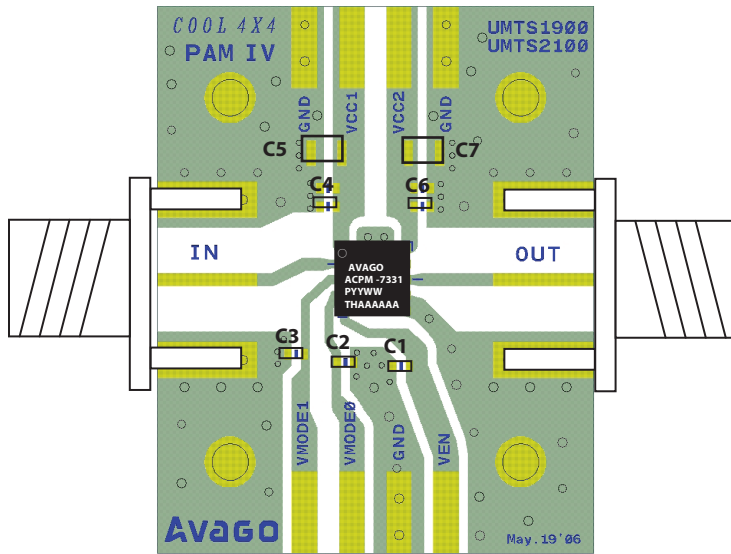

Figure 12. Evaluation Board Assembly Diagram

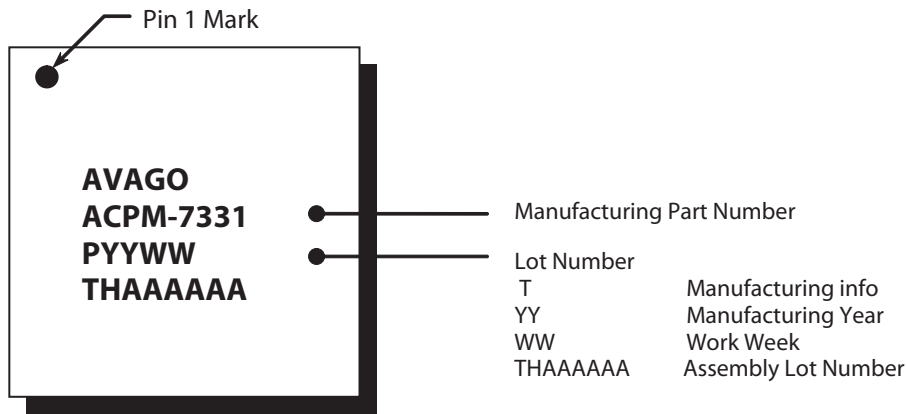
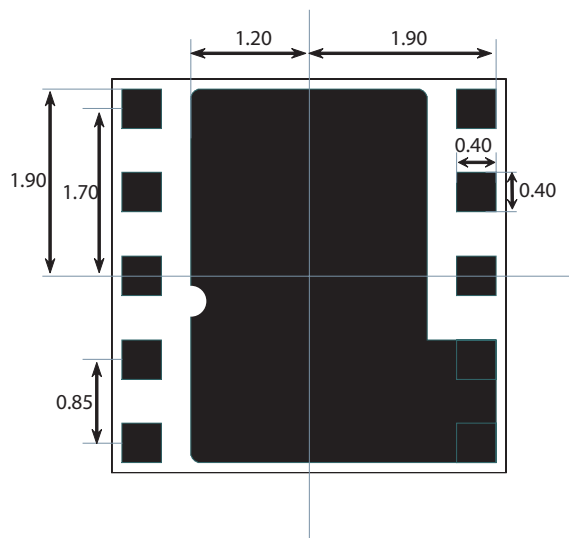
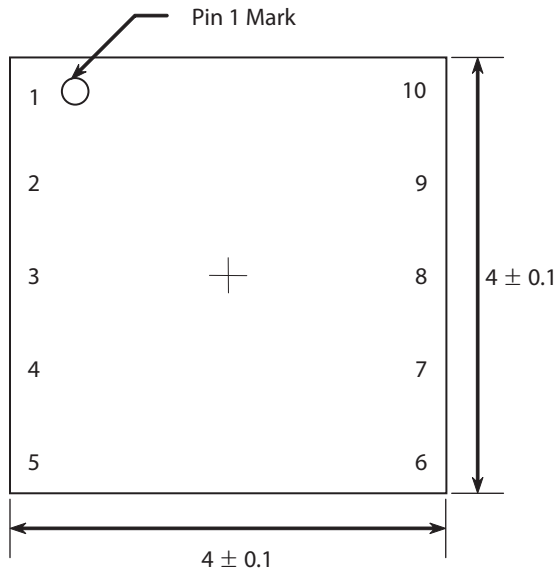

Figure 13. Marking Specifications

Package Dimensions and Pin Descriptions



Pin #	Name	Description
1	Vcc1	Supply Voltage
2	RF In	RF Input
3	Vmode1	Control Voltage
4	Vmode0	Control Voltage
5	Ven	Enable Voltage
6	GND	Ground
7	GND	Ground
8	RF Out	RF Output
9	GND	Ground
10	Vcc2	Supply Voltage

PIN DESCRIPTIONS

Figure 14. Package Dimensional Drawing and Pin Descriptions (All dimensions are in millimeters)

CoolPAM

Avago Technologies' CoolPAM is stage-bypass PA technology which saves more power compared with conventional PA. With this technology, the ACPM-7331 has very low quiescent current and efficiencies at low and medium output power ranges are very high.

Incorporation of bias circuit

The ACPM-7331 has internal bias circuit, which removes the need for external constant voltage source (LDO). PA on/off is controlled by Ven. This is digitally control pin.

3-mode power control with two mode control pins

The ACPM-7331 supports three power modes (low power mode/mid power mode/high power mode) with two mode control pins (Vmode0 and Vmode1). This control scheme enables the ACPM-7331 to save more power, which accordingly gives extended talk time.

PDF (probability density function) in Figure 15 showing distribution of output power of mobile in real field gives motivation for stage-bypass PA. Output power is less than 16dBm for most of operating time (during talking), so it is important to save power consumption at low and medium output power ranges

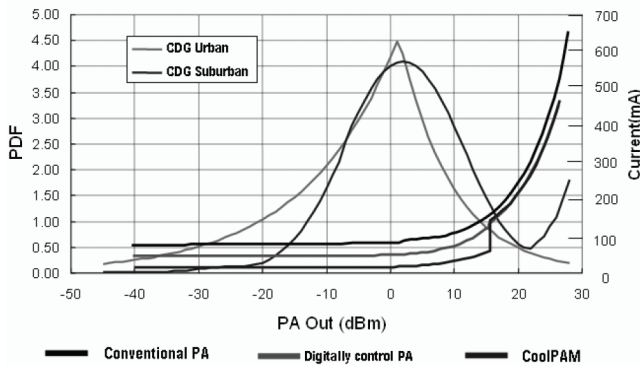

Figure 15. PDF and Current

Average current & Talk time

Average current consumed by PA can be calculated by summing up current at each output power weighted with probability. So it is expressed with integration of multiplication of current and probability at each output power.

$$Average\ current = \int (PDF \times Current) dp$$

Talk time is extended more as average current consumption is lowered.

Mode control pins

Vmode0 and Vmode1 are digitally controlled pins and they control operating mode of PA and truth table is summarized in table 3. These pins do not require constant voltage for interface, but high voltage input range is 1.9 though 2.9V

Application on mobile board

Figure 16 shows one application example on mobile. C4 and C5 should be placed nearby pin1 and pin10. Transmission line length after PA output should be minimized to reduce conduction loss.

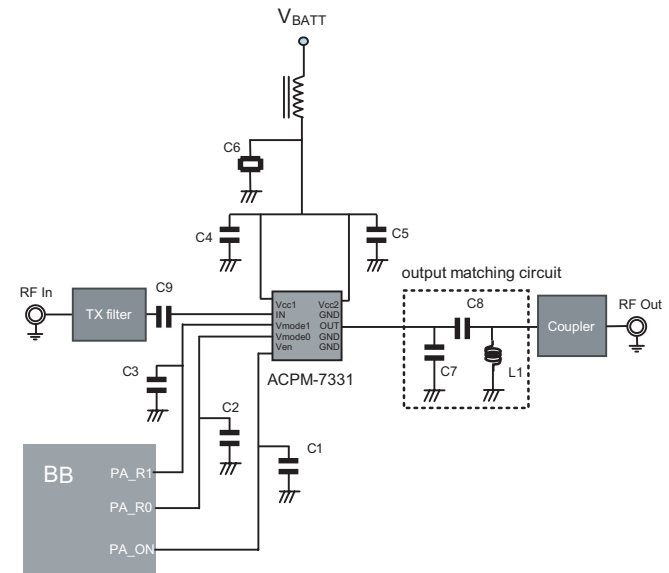
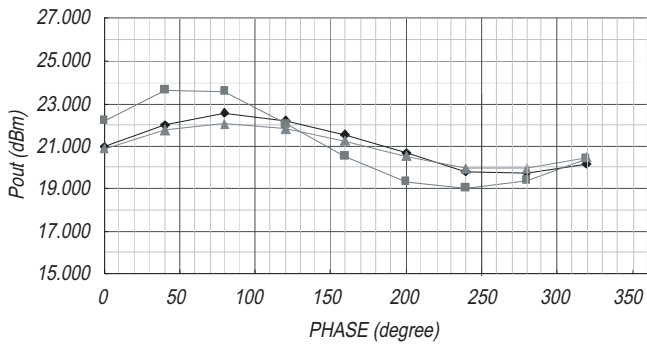

Figure 16. Peripheral Circuits

Load Insensitivity

With the trend to remove the isolator from the Tx chain in UMTS handsets, the performance demands of Load Insensitivity become dependent on the combined performance of the remaining elements in the TX chain: the power amplifier, coupler, antenna as well as the physical layout on the phone board. The ACPM-7331, as part of optimized design, meets the necessary linearity requirements over a 4:1 VSWR mismatch at the antenna plane. In the case of the ACPM-7331, the output stage has been designed for slightly higher Pout to provide the necessary margin to meet linearity under the mismatch experienced at the PA output port resulting from the forced antenna mismatch. Documentation is available that provides a more complete description of the system considerations and measurement considerations.

To illustrate the system performance using the ACPM-7331, Figure 17 shows measurement of TX chain with VSWR fixed at 4:1. ACLR1 is kept higher than -38dBc over all phases and gain variance is about 3dB.



(1) Pout vs. Phase

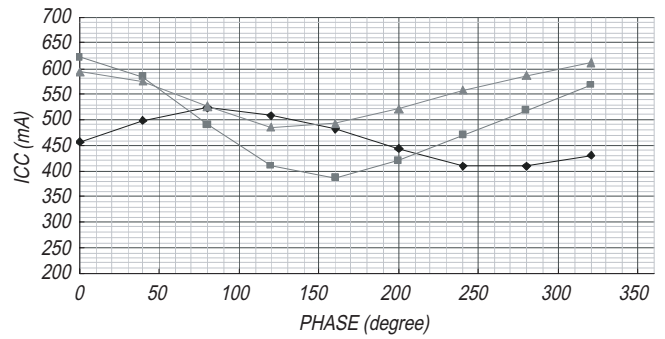

(2) Current vs. Phase

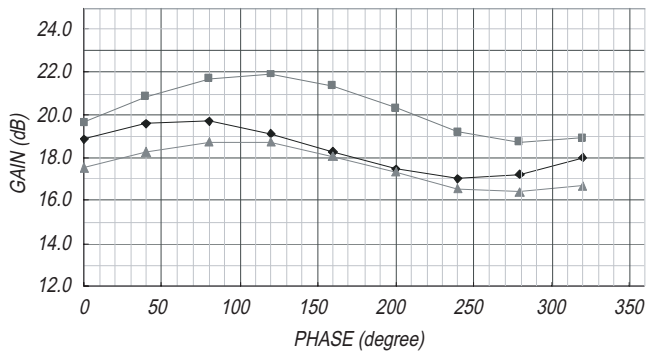

(3) Gain vs. Phase

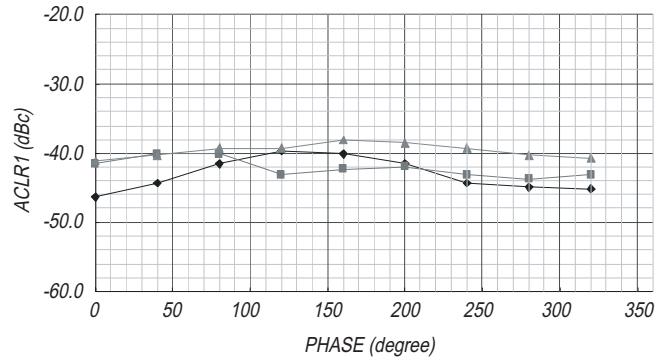

(4) ACLR1(-5MHz offset) vs. Phase

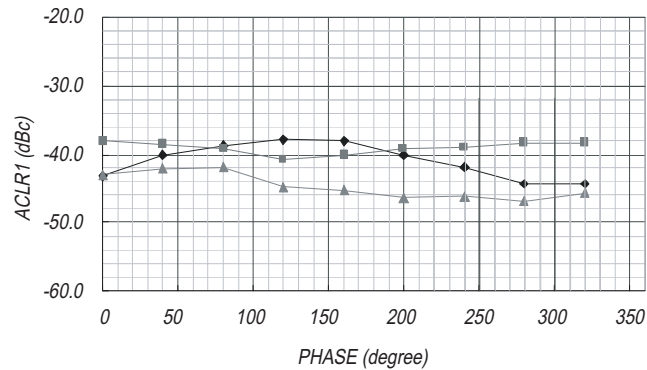

(5) ACLR1(+5MHz Offset) vs. Phase

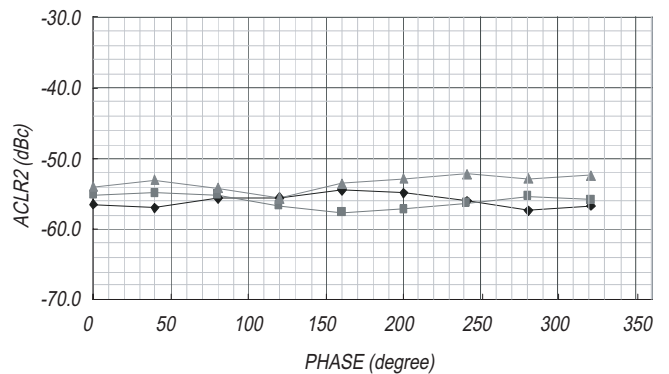

(6) ACLR2(-10MHz offset) vs. Phase

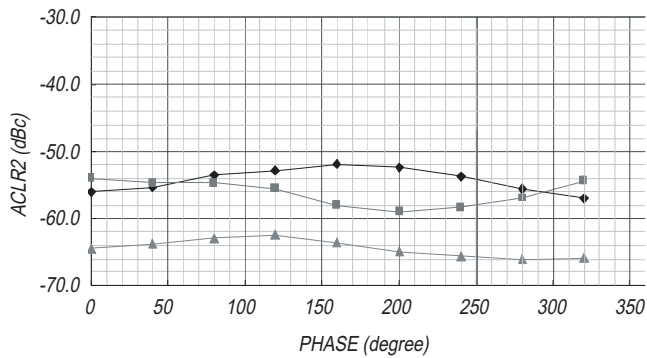

(7) ACLR2(+10MHz Offset) vs. Phase

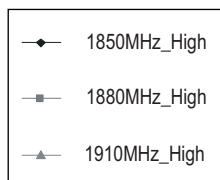

Figure 17. RF Performance of TX path with VSWR 4:1 fixed at Ant plane (Pout=24dBm)

PCB Design Guidelines

The recommended ACPM-7331 PCB land pattern is shown in Figure 18 and Figure 19. The substrate is coated with solder mask between the I/O and conductive paddle to protect the gold pads from short circuit that is caused by solder bleeding/bridging.

Stencil Design Guidelines

A properly designed solder screen or stencil is required to ensure optimum amount of solder paste is deposited onto the PCB pads. The recommended stencil layout is shown in Figure 20. Reducing the stencil opening can potentially generate more voids. On the other hand, stencil openings larger than 100% will lead to excessive solder paste smear or bridging across the I/O pads or conductive paddle to adjacent I/O pads. Considering the fact that solder paste thickness will directly affect the quality of the solder joint, a good choice is to use laser cut stencil composed of 0.10mm(4mils) or 0.127mm(5mils) thick stainless steel which is capable of producing the required fine stencil outline.

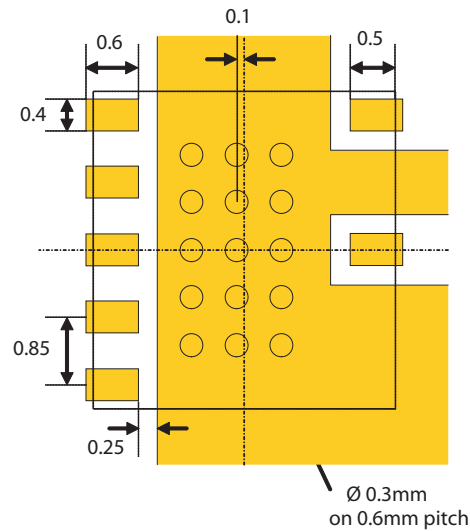

Figure 18. Metallization

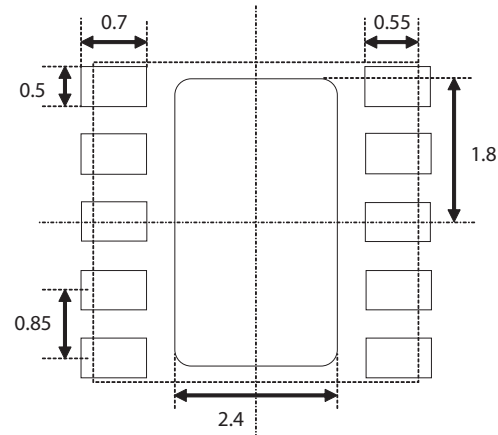

Figure 19. Solder Mask Opening

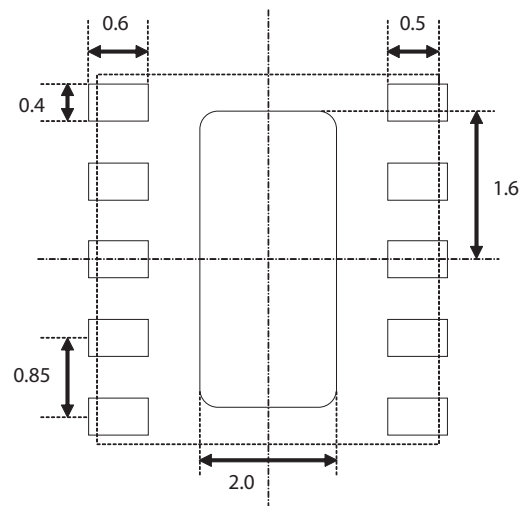
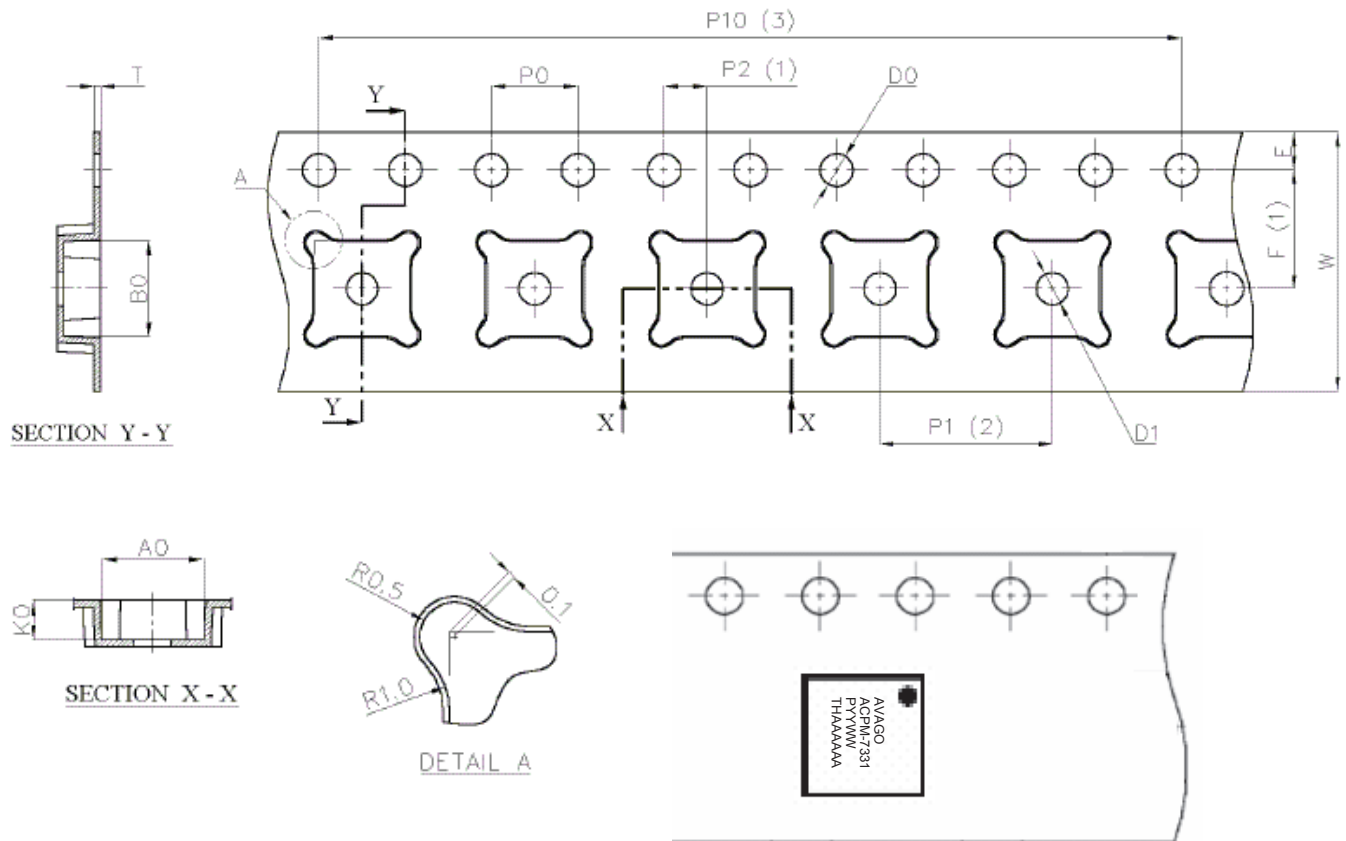

Figure 20. Solder Paste Stencil Aperture

Tape and Reel Information



Dimension List

Dimension	Millimeter
A0	4.40±0.10
B0	4.40±0.10
K0	1.70±0.10
D0	1.55±0.05
D1	1.60±0.10
P0	4.00±0.10
P1	8.00±0.10

Dimension	Millimeter
P2	2.00±0.05
P10	40.00±0.20
E	1.75±0.10
F	5.50±0.05
W	12.00±0.30
T	0.30±0.05

Figure 21. Tape and Reel Format – 4 mm x 4 mm.

Reel Drawing

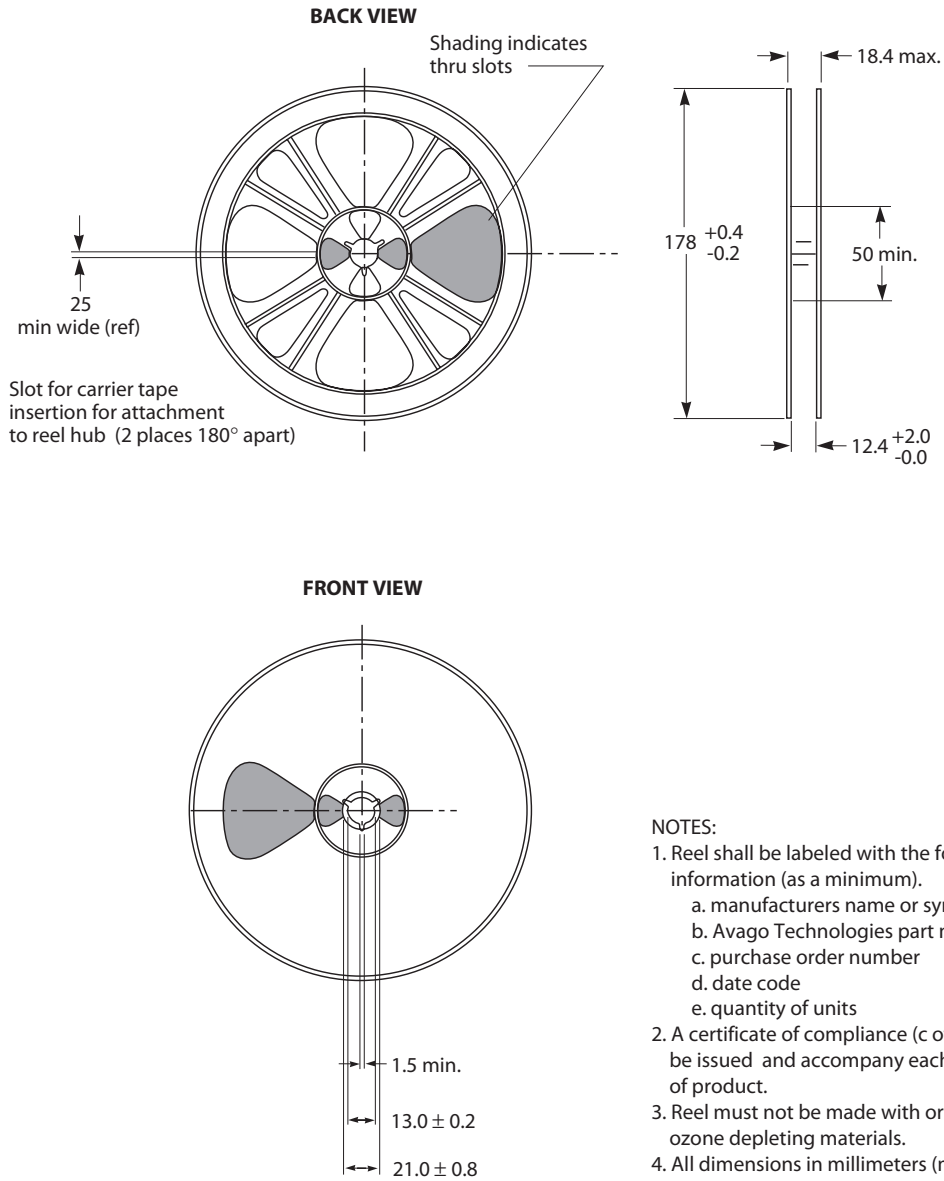

Figure 22. Plastic Reel Format (all dimensions are in millimeters)

Handling and Storage

ESD (Electrostatic Discharge)

Electrostatic discharge occurs naturally in the environment. With the increase in voltage potential, the outlet of neutralization or discharge will be sought. If the acquired discharge route is through a semiconductor device, destructive damage will result.

ESD countermeasure methods should be developed and used to control potential ESD damage during handling in a factory environment at each manufacturing site.

MSL (Moisture Sensitivity Level)

Plastic encapsulated surface mount package is sensitive to damage induced by absorbed moisture and temperature.

Avago Technologies follows JEDEC Standard J-STD 020B. Each component and package type is classified for

moisture sensitivity by soaking a known dry package at various temperatures and relative humidity, and times. After soak, the components are subjected to three consecutive simulated reflows.

The out of bag exposure time maximum limits are determined by the classification test describe below which corresponds to a MSL classification level 6 to 1 according to the JEDEC standard IPC/JEDEC J-STD-020B and J-STD-033.

ACPM-7331 is MSL3. Thus, according to the J-STD-033 p.11 the maximum Manufacturers Exposure Time (MET) for this part is 168 hours. After this time period, the part would need to be removed from the reel, de-taped and then re-baked. MSL classification reflow temperature for the ACPM-7331 is targeted at 260°C +0/-5°C. Figure 23 and Table 8 show typical SMT profile for maximum temperature of 260 +0/-5°C.

Table 6. ESD Classification

Pin #	Name	Description	HBM	CDM	Classification
1	Vcc1	Supply Voltage	± 2000V	± 200V	Class 2
2	RF In	RF Input	± 2000V	± 200V	Class 2
3	Vmode1	Control Voltage	± 2000V	± 200V	Class 2
4	Vmode0	Control Voltage	± 2000V	± 200V	Class 2
5	Ven	Enable Voltage	± 2000V	± 200V	Class 2
6	GND	Ground	± 2000V	± 200V	Class 2
7	GND	Ground	± 2000V	± 200V	Class 2
8	RF Out	RF Output	± 2000V	± 200V	Class 2
9	GND	Ground	± 2000V	± 200V	Class 2
10	Vcc2	Supply Voltage	± 2000V	± 200V	Class 2

Note :

1. Module products should be considered extremely ESD sensitive.

Table 7. Moisture Classification Level and Floor Life

MSL Level	Floor Life (out of bag) at factory ambient =< 30°C/60% RH or as stated
1	Unlimited at =< 30oC/85% RH
2	1 year
2a	4 weeks
3	168 hours
4	72 hours
5	48 hours
5a	24 hours
6	Mandatory bake before use. After bake, must be reflowed within the time limit specified on the label

Note :

1. The MSL Level is marked on the MSL Label on each shipping bag.

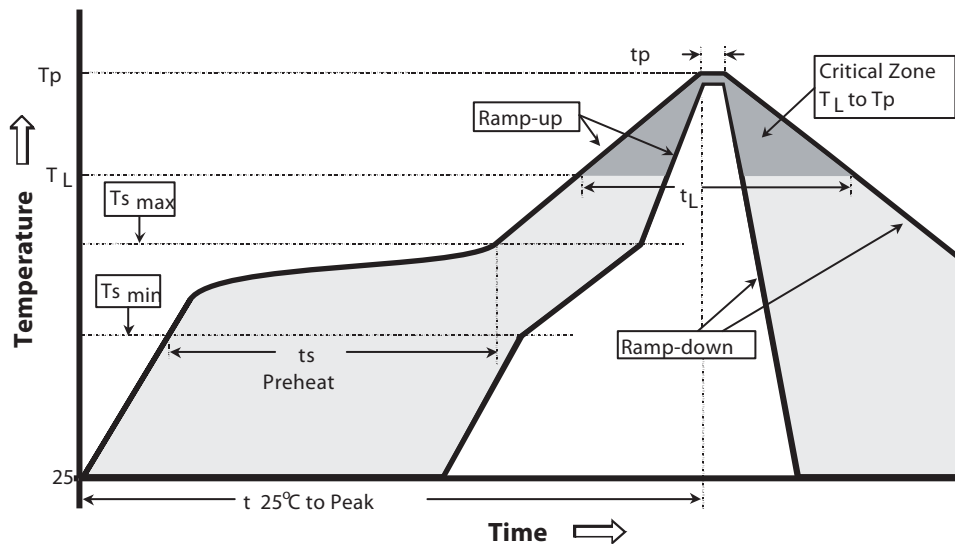

Figure 23. Typical SMT Reflow Profile for Maximum Temperature = 260 +0/-5°C

Table 8. Typical SMT Reflow Profile for Maximum Temperature = 260+0 / -5°C

Profile Feature	Sn-Pb Solder	Pb-Free Solder
Average ramp-up rate (TL to TP)	3°C/sec max	3°C /sec max
Preheat		
- Temperature Min (T _{smin})	100°C	150°C
- Temperature Max (T _{smax})	150°C	200°C
- Time (min to max) (t _s)	60-120 sec	60-180 sec
T _{smax} to T _L		
- Ramp-up Rate		3°C /sec max
Time maintained above:		
- Temperature (T _L)	183°C	217°C
- Time (T _L)	60-150 sec	60-150 sec
Peak temperature (T _p)	240 +0/-5°C	260 +0/-5°C
Time within 5°C of actual Peak Temperature (t _p)	10-30 sec	20-40 sec
Ramp-down Rate	6°C /sec max	6°C /sec max
Time 25°C to Peak Temperature	6 min max.	8 min max.

Storage Condition

Packages described in this document must be stored in sealed moisture barrier, antistatic bags. Shelf life in a sealed moisture barrier bag is 12 months at <40°C and 90% relative humidity (RH) J-STD-033 p.7.

Out-of-Bag Time Duration

After unpacking the device must be soldered to the PCB within 168 hours as listed in the J-STD-020B p.11 with factory conditions <30°C and 60% RH.

Baking

It is not necessary to re-bake the part if both conditions (storage conditions and out-of bag conditions) have been satisfied. Baking must be done if at least one of the conditions above have not been satisfied. The baking conditions are 125°C for 12 hours J-STD-033 p.8.

CAUTION

Tape and reel materials typically cannot be baked at the temperature described above. If out-of-bag exposure time is exceeded, parts must be baked for a longer time at low temperatures, or the parts must be de-reeled, de-taped, re-baked and then put back on tape and reel. (See moisture sensitive warning label on each shipping bag for information of baking).

Board Rework

Component Removal, Rework and Remount

If a component is to be removed from the board, it is recommended that localized heating be used and the maximum body temperatures of any surface mount component on the board not exceed 200°C. This method will minimize moisture related component damage. If any component temperature exceeds 200°C, the board must be baked dry per 4-2 prior to rework and/or component removal. Component temperatures shall be measured at the top center of the package body. Any SMD packages that have not exceeded their floor life can be exposed to a maximum body temperature as high as their specified maximum reflow temperature.

Removal for Failure Analysis

Not following the above requirements may cause moisture/reflow damage that could hinder or completely prevent the determination of the original failure mechanism.

Baking of Populated Boards

Some SMD packages and board materials are not able to withstand long duration bakes at 125°C. Examples of this are some FR-4 materials, which cannot withstand a 24 hr bake at 125°C. Batteries and electrolytic capacitors are also temperature sensitive. With component and board temperature restrictions in mind, choose a bake temperature from Table 4-1 in J-STD 033; then determine the appropriate bake duration based on the component to be removed. For additional considerations see IPC-7711 and IPC-7721.

Derating due to Factory Environmental Conditions

Factory floor life exposures for SMD packages removed from the dry bags will be a function of the ambient environmental conditions. A safe, yet conservative, handling approach is to expose the SMD packages only up to the maximum time limits for each moisture sensitivity level as shown in Table 7. This approach, however, does not work if the factory humidity or temperature is greater than the testing conditions of 30°C/60% RH. A solution for addressing this problem is to derate the exposure times based on the knowledge of moisture diffusion in the component package materials ref. JESD22-A120). Recommended equivalent total floor life exposures can be estimated for a range of humidities and temperatures based on the nominal plastic thickness for each device.

Table 9 lists equivalent derated floor lives for humidities ranging from 20-90% RH for three temperature, 20°C, 25°C, and 30°C.

This table is applicable to SMDs molded with novolac, biphenyl or multifunctional epoxy mold compounds. The following assumptions were used in calculating Table 9:

1. Activation Energy for diffusion = 0.35eV (smallest known value).
2. For ≤60% RH, use Diffusivity = $0.121 \exp(-0.35\text{eV}/kT)$ mm²/s (this used smallest known Diffusivity @ 30°C).
3. For >60% RH, use Diffusivity = $1.320 \exp(-0.35\text{eV}/kT)$ mm²/s (this used largest known Diffusivity @ 30°C).

Table 9. Recommended Equivalent Total Floor Life (days) @ 20 °C , 25°C & 30°C For ICs with Novolac, Biphenyl and Multifunctional Epoxies (Reflow at same temperature at which the component was classified)

Maximum Percent Relative Humidity

Package Type and Body Thickness	Moisture Sensitivity Level	5%	10%	20%	30%	40%	50%	60%	70%	80%	90%			
Body Thickness ≥3.1 mm Including PQFPs >84 pin, PLCCs (square) All MQFPs or All BGAs ≥1 mm	Level 2a	∞	∞	∞	60	41	33	28	10	7	6	30°		
		∞	∞	∞	78	53	42	36	14	10	8	25°		
		∞	∞	∞	103	69	57	47	19	13	10	20°		
	Level 3	∞	∞	10	9	8	7	7	5	4	4	30°		
		∞	∞	13	11	10	9	9	7	6	5	25°		
		∞	∞	17	14	13	12	12	10	8	7	20°		
	Level 4	∞	5	4	4	4	3	3	3	2	2	30°		
		∞	6	5	5	5	5	4	3	3	3	25°		
		∞	8	7	7	7	7	6	5	4	4	20°		
	Level 5	∞	4	3	3	2	2	2	2	1	1	30°		
		∞	5	5	4	4	3	3	2	2	2	25°		
		∞	7	7	6	5	5	4	3	2	3	20°		
	Level 5a	∞	2	1	1	1	1	1	1	1	1	30°		
		∞	3	2	2	2	2	2	1	1	1	25°		
		∞	5	4	3	3	3	2	2	2	2	20°		
	Body 2.1 mm ≤ Thickness <3.1 mm including PLCCs (rectangular) 18-32 pin SOICs (wide body) SOICs ≥20 pins, PQFPs ≤80 pins	Level 2a	∞	∞	∞	∞	86	39	28	4	3	2	30°	
			∞	∞	∞	∞	148	51	37	6	4	3	25°	
			∞	∞	∞	∞	∞	69	49	8	5	4	20°	
Level 3		∞	∞	19	12	9	8	7	3	2	2	30°		
		∞	∞	25	15	12	10	9	5	3	3	25°		
		∞	∞	32	19	15	13	12	7	5	4	20°		
Level 4		∞	7	5	4	4	3	3	2	2	1	30°		
		∞	9	7	5	5	4	4	3	2	2	25°		
		∞	11	9	7	6	6	5	4	3	3	20°		
Level 5		∞	4	3	3	2	2	2	1	1	1	30°		
		∞	5	4	3	3	3	3	2	1	1	25°		
		∞	6	5	5	4	4	4	3	3	2	20°		
Level 5a		∞	2	1	1	1	1	1	1	0.5	0.5	30°		
		∞	2	2	2	2	2	2	1	1	1	25°		
		∞	3	2	2	2	2	2	2	2	1	20°		
Body Thickness <2.1 mm including SOICs <18 pin All TQFPs, TSOPs or All BGAs <1 mm body thickness		Level 2a	∞	∞	∞	∞	∞	∞	28	1	1	1	30°	
			∞	∞	∞	∞	∞	∞	∞	∞	2	1	1	25°
			∞	∞	∞	∞	∞	∞	∞	∞	2	2	1	20°
	Level 3	∞	∞	∞	∞	∞	11	7	1	1	1	30°		
		∞	∞	∞	∞	∞	14	10	2	1	1	25°		
		∞	∞	∞	∞	∞	20	13	2	2	1	20°		
	Level 4	∞	∞	∞	9	5	4	3	1	1	1	30°		
		∞	∞	∞	12	7	5	4	2	1	1	25°		
		∞	∞	∞	17	9	7	6	2	2	1	20°		
	Level 5	∞	∞	13	5	3	2	2	1	1	1	30°		
		∞	∞	18	6	4	3	3	2	1	1	25°		
		∞	∞	26	8	6	5	4	2	2	1	20°		
	Level 5a	∞	10	3	2	1	1	1	1	1	0.5	30°		
		∞	13	5	3	2	2	2	1	1	1	25°		
		∞	18	6	4	3	2	2	2	2	1	20°		

For product information and a complete list of distributors, please go to our web site: www.avagotech.com

Avago, Avago Technologies, and the A logo are trademarks of Avago Technologies, Limited in the United States and other countries.
Data subject to change. Copyright © 2007 Avago Technologies Limited. All rights reserved.
AV02-0645EN - September 4, 2007



Looking for pricing, stock, or lifecycle information?

Click below to explore more details on WIN SOURCE:

 [View ACPM-7331-TR1 on WIN SOURCE](#)

 [Broadcom Limited Information](#)

Optimize Your Supply Chain with WIN SOURCE Solutions

-  Global Sourcing Solution
-  Obsolete Management
-  Cost Control Management
-  Shortage Management
-  Alternative Solution
-  Excess Inventory Management