



THE DATASHEET OF ESDAXLC6-1BU2



Single-line bidirectional ESD protection for high speed interface

Datasheet - production data

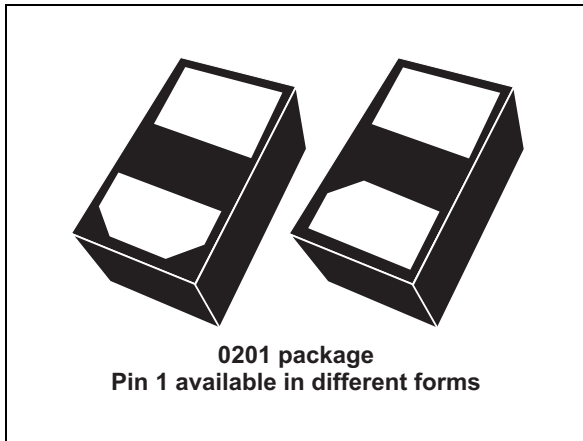
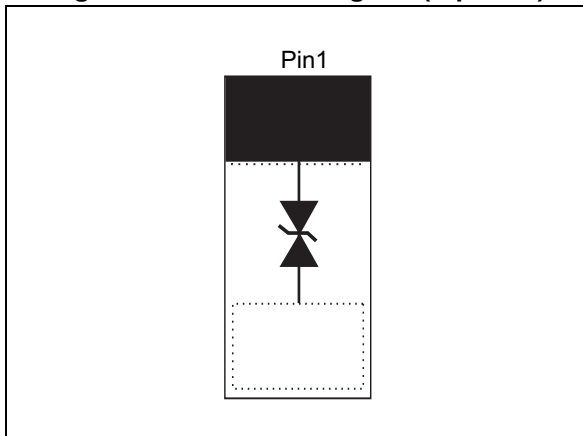
**Figure 1. Functional diagram (top view)****Features**

- Bidirectional device
- Extra low diode capacitance: 0.4 pF
- Low leakage current
- 0201 SMD package size compatible
- Ultra small PCB area: 0.18 mm²
- ECOPACK[®]2 and RoHS compliant component

Complies with the following standards:

- IEC 61000-4-2 level 4
 - ±15 kV (air discharge)
 - ±8 kV (contact discharge)

Applications

Where transient overvoltage protection in ESD sensitive equipment is required, such as:

- Smartphones, mobile phone and accessories
- Tablet PCs, netbooks and notebooks
- Portable multimedia devices and accessories
- Digital cameras and camcorders
- Communication and highly integrated systems

Description

The ESDAXLC6-1BU2 is a bidirectional single line TVS diode designed to protect the data lines or other I/O ports against ESD transients.

The device is ideal for applications where both reduced line capacitance and board space saving are required.

1 Characteristics

Table 1. Absolute maximum ratings ($T_{amb} = 25\text{ °C}$)

Symbol	Parameter	Value	Unit
V_{PP}	Peak pulse voltage: IEC 61000-4-2 contact discharge IEC 61000-4-2 air discharge	± 16 ± 25	kV
P_{PP}	Peak pulse power (8/20 μ s)	40	W
I_{PP}	Peak pulse current (8/20 μ s)	1.3	A
T_j	Operating junction temperature range	- 40 to +150	$^{\circ}\text{C}$
T_{stg}	Storage temperature range	- 65 to +150	$^{\circ}\text{C}$
T_L	Maximum lead temperature for soldering during 10 s	260	$^{\circ}\text{C}$

Note: For a surge greater than the maximum values, the diode will fail in short-circuit

Figure 2. Electrical characteristics (definitions)

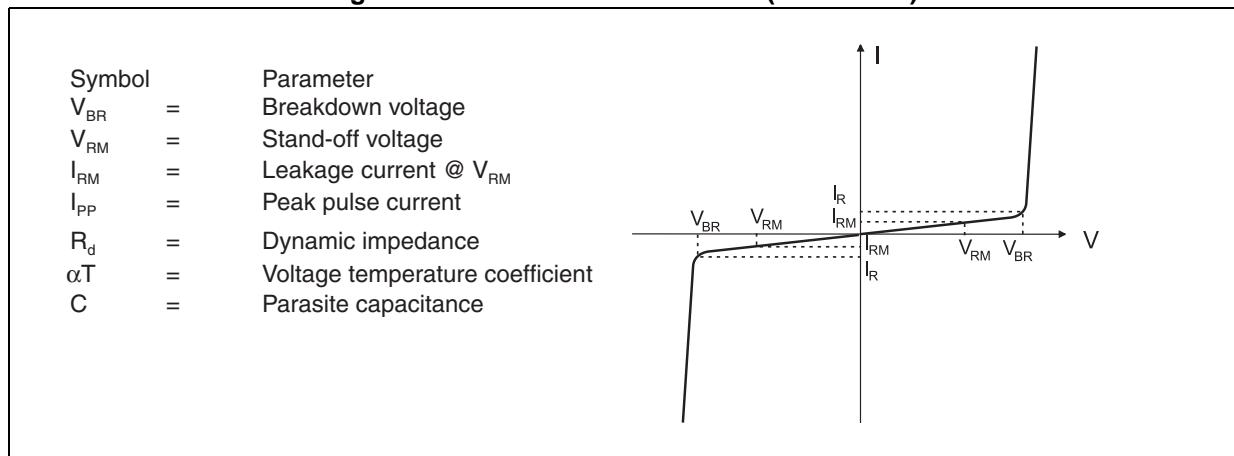

Table 2. Electrical characteristics (values, $T_{amb} = 25\text{ °C}$)

Symbol	Test Condition	Min.	Typ.	Max.	Unit
V_{BR}	$I_R = 1\text{ mA}$	6			V
I_{RM}	$V_{RM} = 3\text{ V}$			70	nA
V_{CL}	$I_{PP} = 1\text{ A}, 8/20\ \mu\text{A}$			17	V
C_{line}	$F = (200\text{ MHz}- 3000\text{ MHz}), V_R = 0\text{ V}$		0.4	0.5	pF

Figure 3. Leakage current versus junction temperature (typical values)

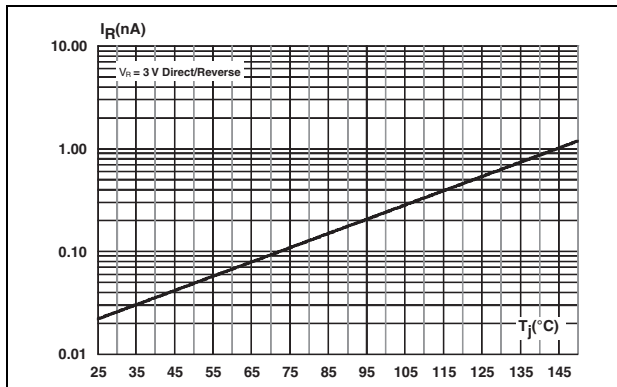

Figure 4. Junction capacitance versus applied voltage (typical values)

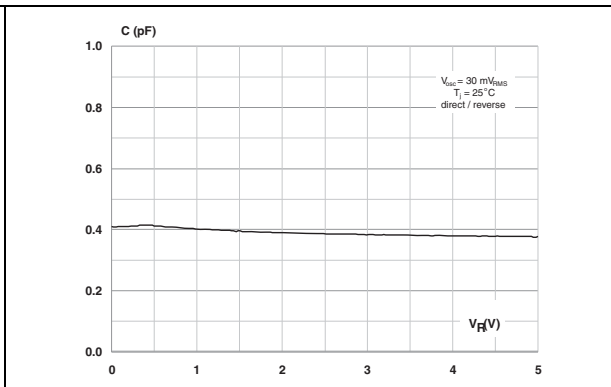

Figure 5. ESD response to IEC 61000-4-2 (+8 kV contact discharge)

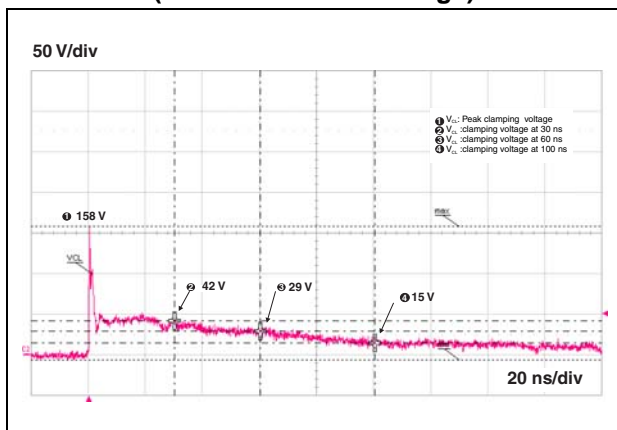

Figure 6. ESD response to IEC 61000-4-2 (-8 kV contact discharge)

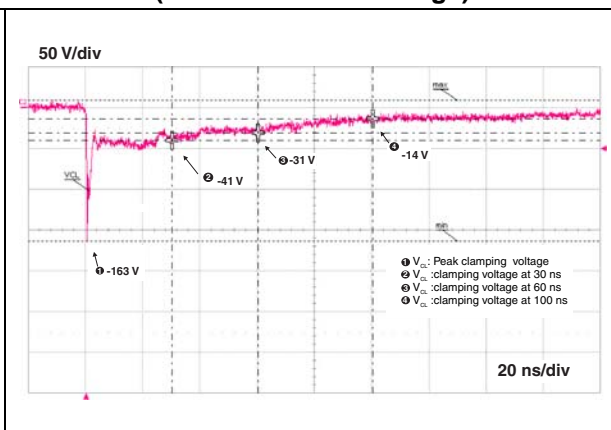
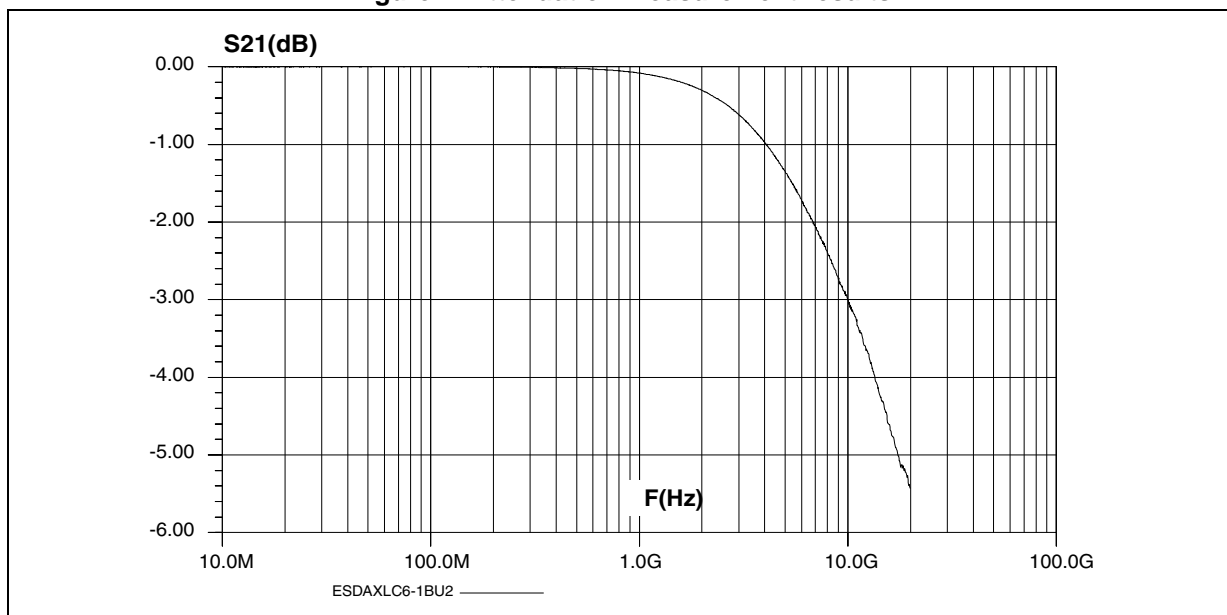

Figure 7. Attenuation measurement results



2 Package information

- Epoxy meets UL94, V0
- Lead-free package

In order to meet environmental requirements, ST offers these devices in different grades of ECOPACK® packages, depending on their level of environmental compliance. ECOPACK® specifications, grade definitions and product status are available at: www.st.com. ECOPACK® is an ST trademark.

Figure 8. 0201 dimension definitions

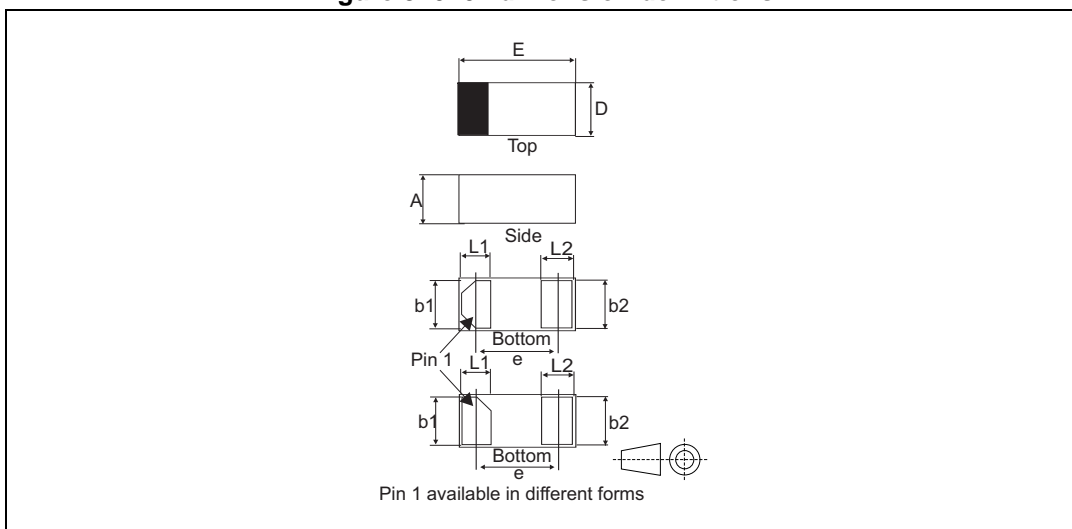

Table 3. 0201 package dimension values

Ref.	Dimensions					
	Millimeters			Inches		
	Min.	Typ.	Max.	Min.	Typ.	Max.
A	0.23	0.28	0.33	0.0091	0.0110	0.0130
b1	0.20	0.25	0.30	0.0079	0.0098	0.0118
b2	0.20	0.25	0.30	0.0079	0.0098	0.0118
D	0.25	0.30	0.35	0.0099	0.0118	0.0138
E	0.55	0.60	0.65	0.0217	0.0236	0.0256
e		0.35			0.0138	
L1	0.13	0.18	0.23	0.0052	0.0071	0.0091
L2	0.14	0.19	0.24	0.0055	0.0075	0.0095

Figure 9. Footprint dimensions in mm (inches)

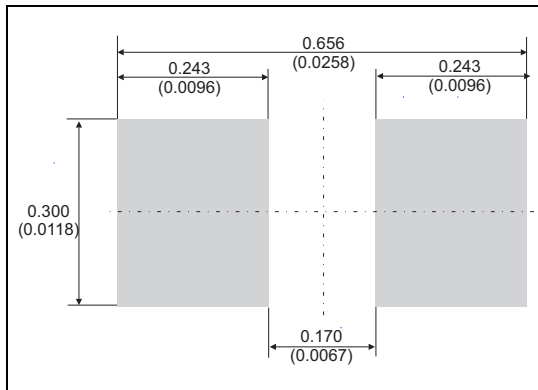
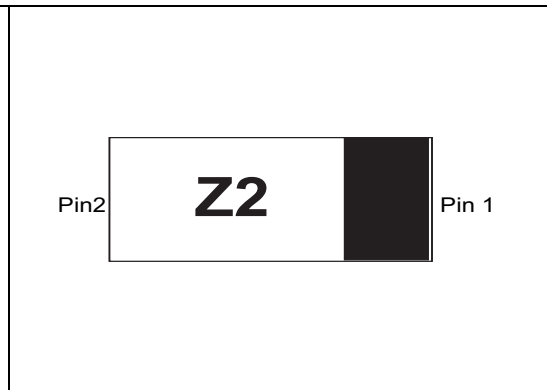
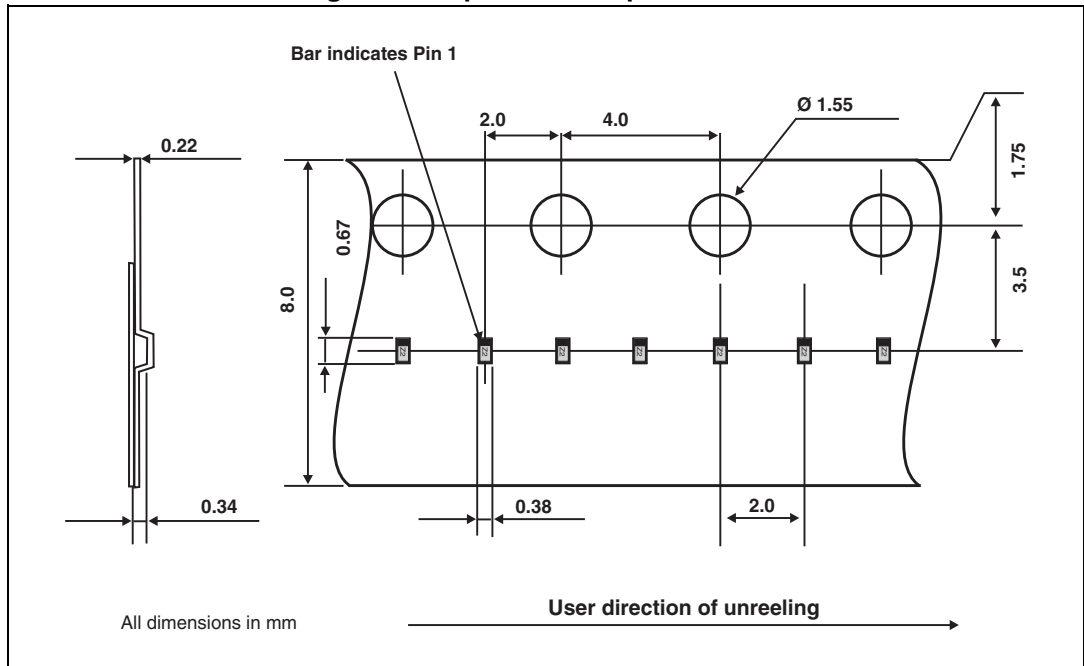

Figure 10. Marking



Note: Product marking may be rotated by 180° for assembly plant differentiation. In no case should this product marking be used to orient the component for its placement on a PCB. Only pin 1 mark is to be used for this purpose.

Figure 11. Tape and reel specifications



3 Recommendation on PCB assembly

3.1 Stencil opening design

Figure 12. Recommended stencil windows position

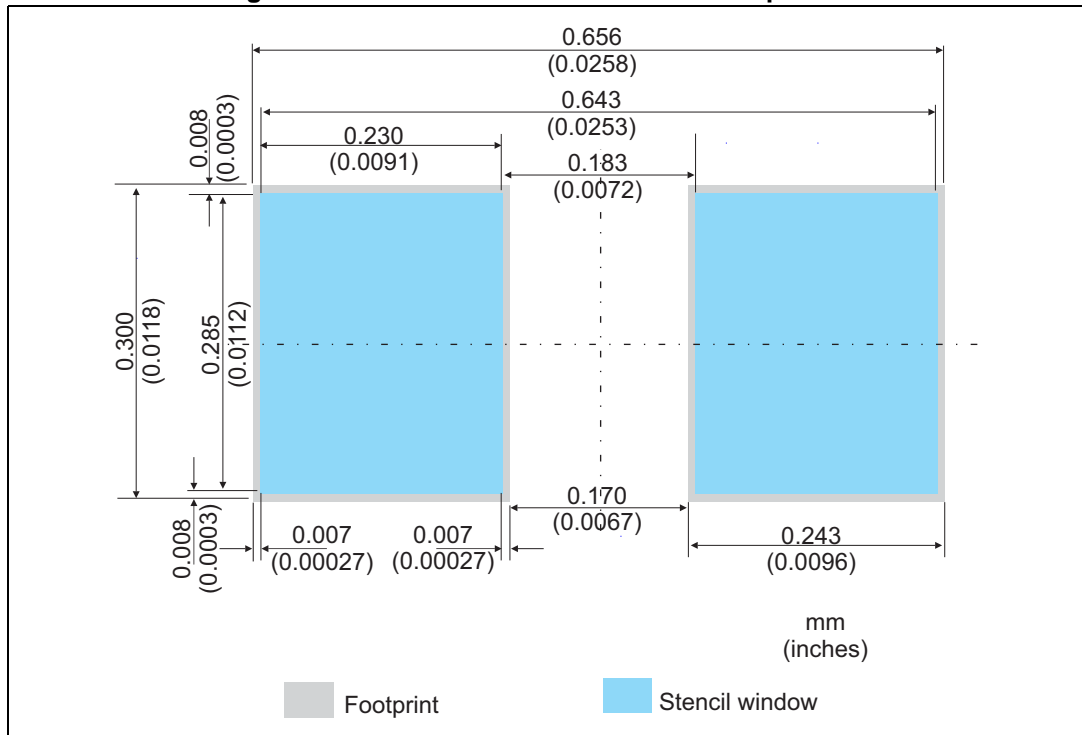

3.2 Solder paste

1. Halide-free flux qualification ROL0 according to ANSI/J-STD-004.
2. "No clean" solder paste is recommended.
3. Offers a high tack force to resist component movement during high speed
4. Solder paste with fine particles: powder particle size is 20-45 μm .

3.3 Placement

1. Manual positioning is not recommended.
2. It is recommended to use the lead recognition capabilities of the placement system, not the outline centering
3. Standard tolerance of ± 0.05 mm is recommended.
4. 3.5 N placement force is recommended. Too much placement force can lead to squeezed out solder paste and cause solder joints to short. Too low placement force can lead to insufficient contact between package and solder paste that could cause open solder joints or badly centered packages.
5. To improve the package placement accuracy, a bottom side optical control should be performed with a high resolution tool.
6. For assembly, a perfect supporting of the PCB (all the more on flexible PCB) is recommended during solder paste printing, pick and place and reflow soldering by using optimized tools.

3.4 PCB design preference

1. To control the solder paste amount, the closed via is recommended instead of open vias.
2. The position of tracks and open vias in the solder area should be well balanced. The symmetrical layout is recommended, in case any tilt phenomena caused by asymmetrical solder paste amount due to the solder flow away.

3.5 Reflow profile

Figure 13. ST ECOPACK[®] recommended soldering reflow profile for PCB mounting

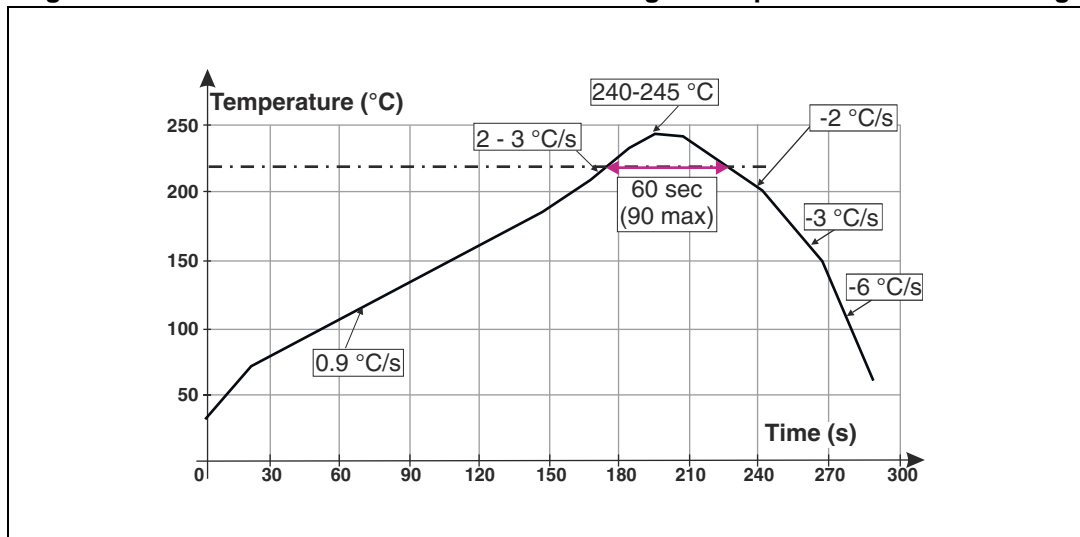

Note: Minimize air convection currents in the reflow oven to avoid component movement.
Maximum soldering profile corresponds to the latest IPC/JEDEC J-STD-020.

4 Ordering information

Figure 14. Ordering information scheme

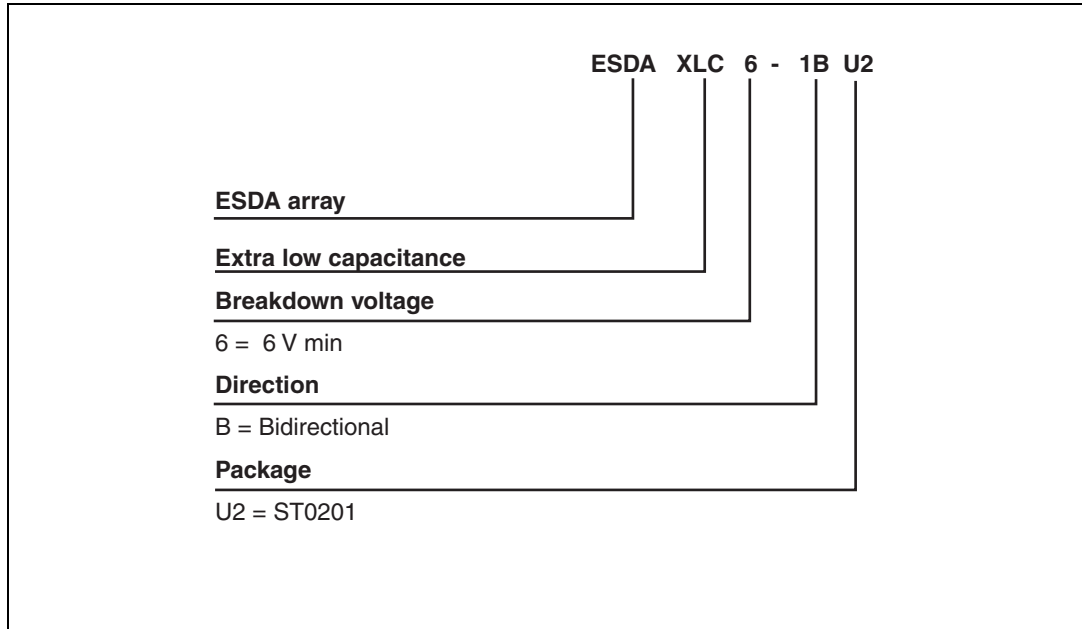

Table 4. Ordering information

Order code	Marking	Weight	Base qty	Delivery mode
ESDAXLC6-1BU2	Z2 ⁽¹⁾	0.124 mg	15000	Tape and reel

1. The marking can be rotated by 180° to differentiate assembly location

5 Revision history

Table 5. Document revision history

Date	Revision	Changes
21-Sep-2012	1	Initial release.
27-Mar-2014	2	Updated Figure 5 , Figure 6 , Figure 7 , Figure 9 and Figure 13 . Updated package graphics.

Please Read Carefully:

Information in this document is provided solely in connection with ST products. STMicroelectronics NV and its subsidiaries ("ST") reserve the right to make changes, corrections, modifications or improvements, to this document, and the products and services described herein at any time, without notice.

All ST products are sold pursuant to ST's terms and conditions of sale.

Purchasers are solely responsible for the choice, selection and use of the ST products and services described herein, and ST assumes no liability whatsoever relating to the choice, selection or use of the ST products and services described herein.

No license, express or implied, by estoppel or otherwise, to any intellectual property rights is granted under this document. If any part of this document refers to any third party products or services it shall not be deemed a license grant by ST for the use of such third party products or services, or any intellectual property contained therein or considered as a warranty covering the use in any manner whatsoever of such third party products or services or any intellectual property contained therein.

UNLESS OTHERWISE SET FORTH IN ST'S TERMS AND CONDITIONS OF SALE ST DISCLAIMS ANY EXPRESS OR IMPLIED WARRANTY WITH RESPECT TO THE USE AND/OR SALE OF ST PRODUCTS INCLUDING WITHOUT LIMITATION IMPLIED WARRANTIES OF MERCHANTABILITY, FITNESS FOR A PARTICULAR PURPOSE (AND THEIR EQUIVALENTS UNDER THE LAWS OF ANY JURISDICTION), OR INFRINGEMENT OF ANY PATENT, COPYRIGHT OR OTHER INTELLECTUAL PROPERTY RIGHT.

ST PRODUCTS ARE NOT DESIGNED OR AUTHORIZED FOR USE IN: (A) SAFETY CRITICAL APPLICATIONS SUCH AS LIFE SUPPORTING, ACTIVE IMPLANTED DEVICES OR SYSTEMS WITH PRODUCT FUNCTIONAL SAFETY REQUIREMENTS; (B) AERONAUTIC APPLICATIONS; (C) AUTOMOTIVE APPLICATIONS OR ENVIRONMENTS, AND/OR (D) AEROSPACE APPLICATIONS OR ENVIRONMENTS. WHERE ST PRODUCTS ARE NOT DESIGNED FOR SUCH USE, THE PURCHASER SHALL USE PRODUCTS AT PURCHASER'S SOLE RISK, EVEN IF ST HAS BEEN INFORMED IN WRITING OF SUCH USAGE, UNLESS A PRODUCT IS EXPRESSLY DESIGNATED BY ST AS BEING INTENDED FOR "AUTOMOTIVE, AUTOMOTIVE SAFETY OR MEDICAL" INDUSTRY DOMAINS ACCORDING TO ST PRODUCT DESIGN SPECIFICATIONS. PRODUCTS FORMALLY ESCC, QML OR JAN QUALIFIED ARE DEEMED SUITABLE FOR USE IN AEROSPACE BY THE CORRESPONDING GOVERNMENTAL AGENCY.

Resale of ST products with provisions different from the statements and/or technical features set forth in this document shall immediately void any warranty granted by ST for the ST product or service described herein and shall not create or extend in any manner whatsoever, any liability of ST.

ST and the ST logo are trademarks or registered trademarks of ST in various countries.

Information in this document supersedes and replaces all information previously supplied.

The ST logo is a registered trademark of STMicroelectronics. All other names are the property of their respective owners.

© 2014 STMicroelectronics - All rights reserved

STMicroelectronics group of companies



Australia - Belgium - Brazil - Canada - China - Czech Republic - Finland - France - Germany - Hong Kong - India - Israel - Italy - Japan - Malaysia - Malta - Morocco - Philippines - Singapore - Spain - Sweden - Switzerland - United Kingdom - United States of America

www.st.com



Looking for pricing, stock, or lifecycle information?

Click below to explore more details on WIN SOURCE:

-  [View ESDAXLC6-1BU2 on WIN SOURCE](#)
-  [STMicroelectronics Information](#)

Optimize Your Supply Chain with WIN SOURCE Solutions

-  Global Sourcing Solution
-  Obsolete Management
-  Cost Control Management
-  Shortage Management
-  Alternative Solution
-  Excess Inventory Management