



**THE DATASHEET OF
BM20B(0.8)-20DS-0.4V(53)**



0.4 mm Pitch, 0.6 and 0.8 mm Height, Board-to-Board and Board-to-FPC Connectors

BM20 Series

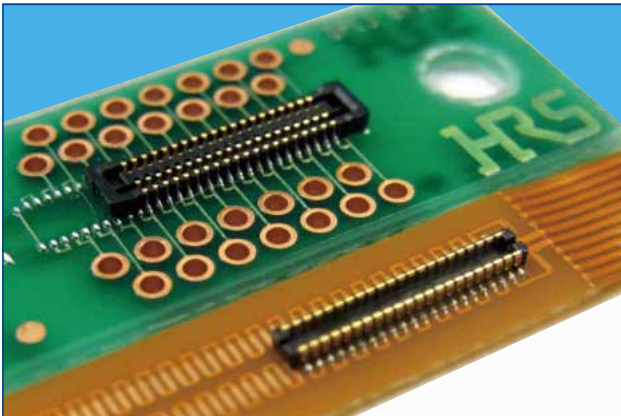

■ Features

1. High density mounting capability

A space saving design that keeps the connector compact, but still maintains an adequate vacuum area (no less than 0.7mm wide).
Depth DS: 2.3 mm DP: 1.78 mm

2. Reliable contact performance

Even though the mated height is low, the BM20 still leads it class in maximum effective mating lengths for each mating height.
<Effective Mating Length>
Height 0.8 mm: 0.2 mm
Height 0.6 mm: 0.15 mm
The addition of the two point contact system adds more reliability to the contacts.

3. No restrictions to PCB pattern design for the 0.8 mm height connector *1

This series utilizes a thin wall to insulate the bottom surface of the connector and maintains an effective mating length of 0.2 mm. This removes any restriction for PCB pattern layout design under the connector.
Note *1: There are some restrictions for the 0.6 mm height style.

4. Enhanced mating operations

The structure uses guide ribs to ease the mating process and offers a self alignment range of up to 0.3 mm. A clear tactile click is used as an indicator to the user that the mating process was completed.

5. Drop and shock resistant structure

Dimples were designed into the contacts to increase their retention force and to absorb the shock delivered from a drop or other impact.

6. Debris resisting design

When mated, the connector's design covers the contacts which help to keep dust and other debris away from the contacts. The SMT leads are kept very close to the connector housing which also helps to prevent shorts caused by debris on the exposed contacts

■ Receptacle

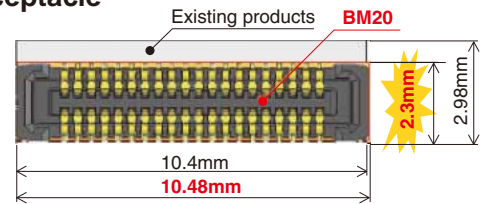

| Existing products | BM20 |
|---|---|
| 2.98×10.4 = About 31.0mm ² | 2.3×10.48 = About 24.1mm ² |

■ Header

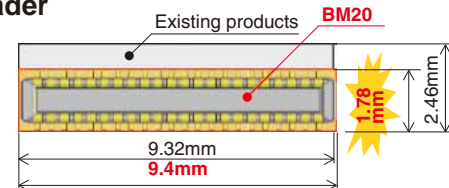

| Existing products | BM20 |
|---|--|
| 2.46×9.32 = About 22.9mm ² | 1.78×9.4 = About 16.7mm ² |

Vacuum pick-up

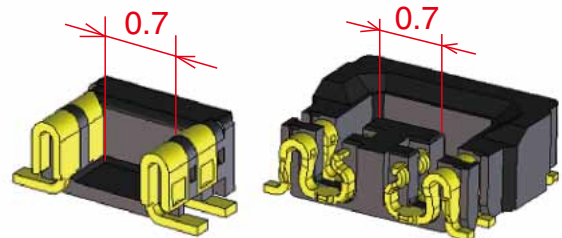

Mating diagram (cross section)

H=0.8

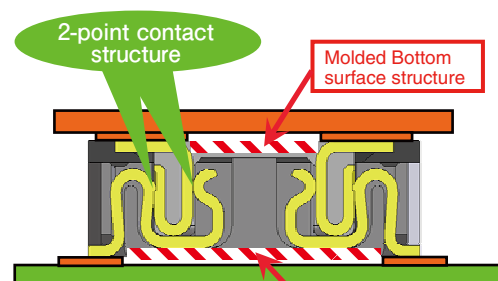

H=0.6

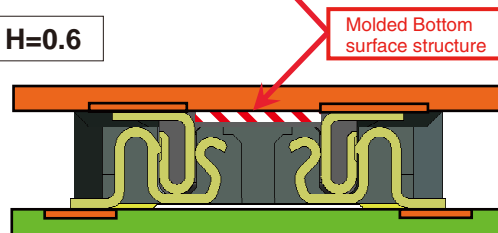

Product Specifications

| | | | | | | |
|---------|---------------|------------|-----------------------------|----------------------|---------------------------|----------------------|
| Ratings | Rated Current | 0.3A | Operating Temperature Range | - 35 ~ 85°C (Note 1) | Storage Temperature Range | - 10 ~ 60°C (Note 2) |
| | Rated Voltage | AC, DC 30V | Operating Humidity Range | 20 ~ 80% | Storage Humidity Range | 40 ~ 70% (Note 2) |

| Items | Specifications | Conditions |
|------------------------------|--|---|
| 1. Insulation Resistance | Minimum of 50 MΩ | Measured with DC 100 V |
| 2. Withstanding Voltage | No flashover or breakdown | Apply AC 100 V for 1 minute |
| 3. Contact Resistance | Maximum of 100 mΩ | Measured with AC 20 mV, 1 kHz and 1 mA |
| 4. Vibration Resistance | No electrical discontinuity of 1μs or greater | Frequency 10-55 Hz, half amplitude 0.75 mm, 3 directions for 2 hours |
| 5. Humidity Resistance | Contact resistance Maximum of 100 mΩ Insulation resistance Minimum of 25 mΩ | Left at temperature 40±2°C, humidity 90 to 95%, 96 hours |
| 6. Temperature Cycles | Contact resistance Maximum of 100 mΩ Insulation resistance Minimum of 50 mΩ | (-55°C: 30 minutes → 5~35°C: 10 minutes → 85°C: 30 minutes → 5~35°C: 10 minutes) 5 cycles |
| 7. Durability | Contact Resistance: maximum of 100 mΩ | 10 mating cycles |
| 8. Soldering Heat Resistance | Should be no melting of resin parts that affects its performance | Reflow: according to the Recommended Solder Profile Hand solder: Soldering iron temperature 350°C, no more than 3 seconds. |

Note 1: Includes temperature rise caused by current flow.

Note 2: The term "storage" here refers to products stored for a long period prior to board mounting and use. The operating temperature and humidity range covers the non-energized condition of connectors after board mounting and the temporary storage conditions during transportation, etc.

Materials

| Product | Component | Materials | Finish | UL Regulation |
|------------|-----------|--------------------|--------------|---------------|
| Receptacle | Insulator | LCP | Black | UL94V-0 |
| Header | Contact | Phosphorous bronze | Gold plating | — |

Product Number Structure

Refer to this page when determining product specifications by model types. Please place orders with part numbers listed in this catalog. The characteristics and specifications of the product described in this catalog are reference values. Please make sure to check the latest delivery specifications at the time of product use.

●Receptacle/Header

BM **20** **#** **(**)** - ***** **DS** - **0.4** **V** **(51)**

① ② ③ ④ ⑤ ⑥ ⑦ ⑧ ⑨

| | |
|--|--|
| ① Series Name: BM | ⑥ Connector Type DS: Double row receptacle DP: Double row header |
| ② Series No.: 20 | |
| ③ Shape Symbols B: With reinforcing metal fitting JC: Connector for conductivity testing | ⑦ Contact Pitch: 0.4 mm |
| | ⑧ Terminal Shape V: Vertical SMT |
| ④ Stack height: 0.6 mm, 0.8 mm | ⑨ Packaging (51): Embossed tape package (8,000 pieces per reel) |
| ⑤ No. of Contacts: | |

■ H=0.6 mm receptacle

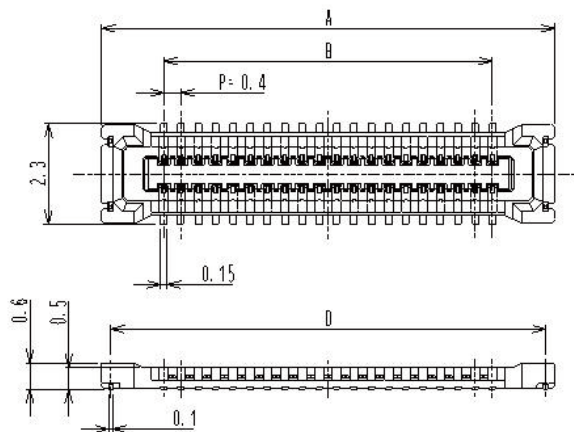
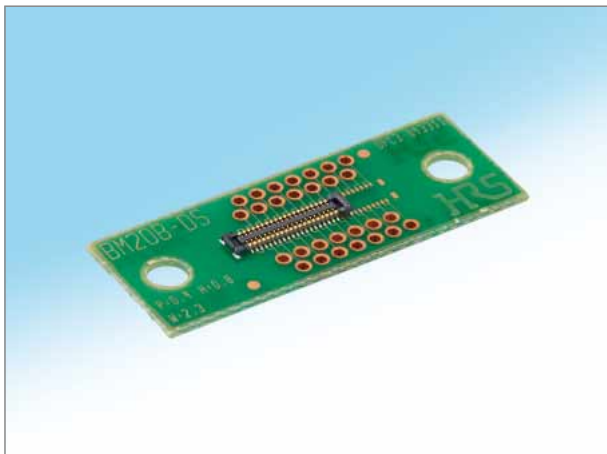

■ H=0.8 mm receptacle

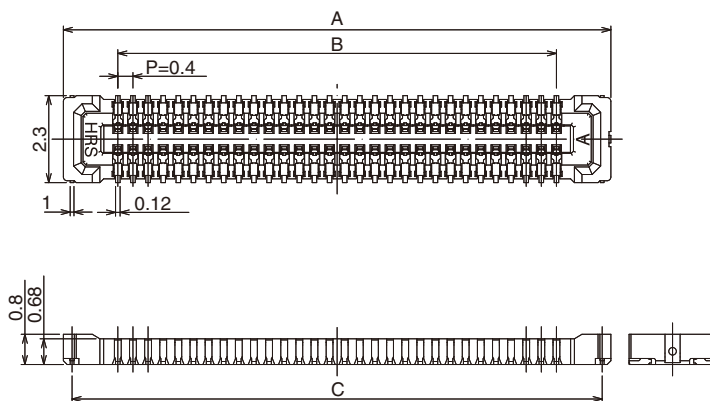

◆ Recommended PCB layout [H= 0.6 mm]

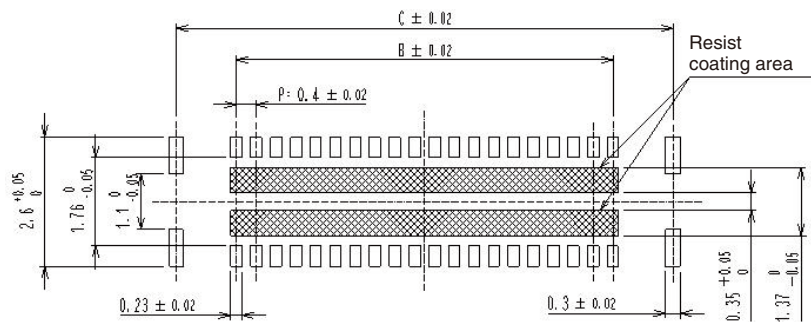

◆ Recommended PCB layout [H= 0.8 mm]

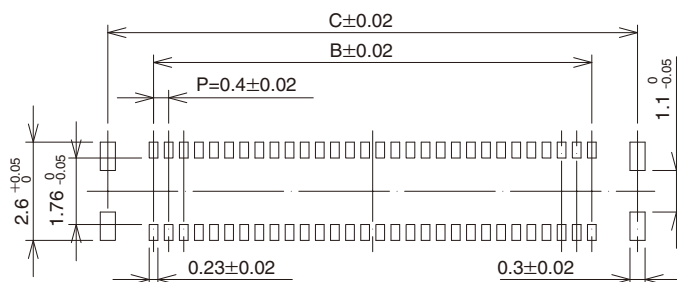

◆ Recommended metal mask size (Mask thickness 100 μm) [0.6 mm and 0.8 mm common]

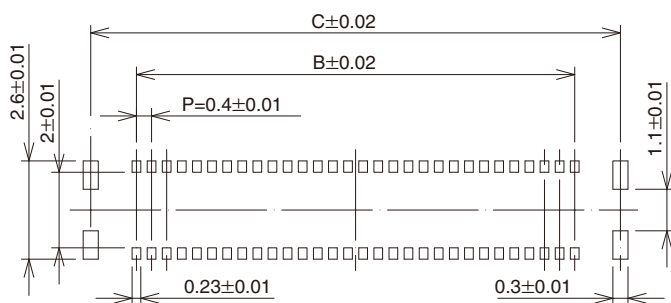

Unit: mm

| Part No. | HRS No. | No. of Contacts | A | B | C | D |
|--------------------------|------------------|-----------------|-------|-----|-------|-------|
| BM20B(0.6)-10DS-0.4V(51) | CL0684-9308-8-51 | 10 | 4.48 | 1.6 | 4.02 | 4.06 |
| BM20B(0.6)-20DS-0.4V(51) | CL0684-9309-0-51 | 20 | 6.48 | 3.6 | 6.02 | 6.06 |
| BM20B(0.6)-24DS-0.4V(51) | CL0684-9310-0-51 | 24 | 7.28 | 4.4 | 6.82 | 6.86 |
| BM20B(0.6)-30DS-0.4V(51) | Under planning | 30 | 8.48 | 5.6 | 8.02 | 8.06 |
| BM20B(0.6)-34DS-0.4V(51) | Under planning | 34 | 9.28 | 6.4 | 8.82 | 8.86 |
| BM20B(0.6)-40DS-0.4V(51) | CL0684-9313-8-51 | 40 | 10.48 | 7.6 | 10.02 | 10.06 |

| Part No. | HRS No. | No. of Contacts | A | B | C |
|--------------------------|------------------|-----------------|-------|-----|-------|
| BM20B(0.8)-10DS-0.4V(51) | CL0684-9008-4-51 | 10 | 4.48 | 1.6 | 4.02 |
| BM20B(0.8)-20DS-0.4V(51) | CL0684-9009-7-51 | 20 | 6.48 | 3.6 | 6.02 |
| BM20B(0.8)-24DS-0.4V(51) | CL0684-9010-6-51 | 24 | 7.28 | 4.4 | 6.82 |
| BM20B(0.8)-30DS-0.4V(51) | CL0684-9011-9-51 | 30 | 8.48 | 5.6 | 8.02 |
| BM20B(0.8)-34DS-0.4V(51) | CL0684-9020-0-51 | 34 | 9.28 | 6.4 | 8.82 |
| BM20B(0.8)-40DS-0.4V(51) | CL0684-9012-1-51 | 40 | 10.48 | 7.6 | 10.02 |
| BM20B(0.8)-44DS-0.4V(51) | Under planning | 44 | 11.28 | 8.4 | 10.82 |
| BM20B(0.8)-50DS-0.4V(51) | Under planning | 50 | 12.48 | 9.6 | 12.02 |

Note 1: This product is sold by full reel quantities of 8,000 pieces per reel. Please place orders in full reel quantities.

Note 2: This connector is NOT polarized.

■ H=0.6 mm header



■ H=0.8 mm header



◆ Recommended PCB layout [0.6 mm and 0.8 mm common]

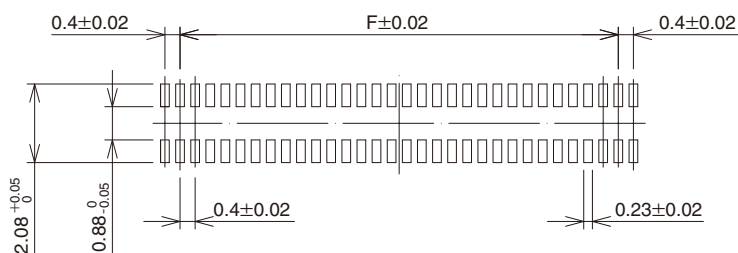

◆ Recommended metal mask size (Mask thickness 100 μm) [0.6 mm and 0.8 mm common]

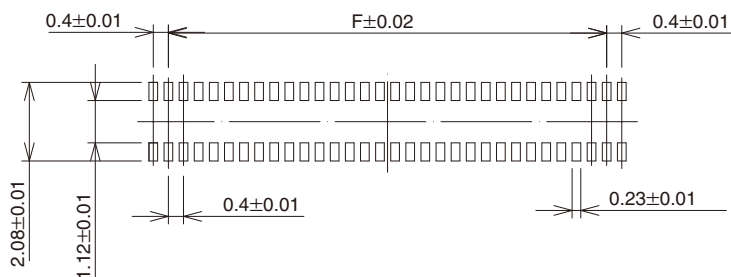

Unit: mm

| Part No | HRS No. | No. of Contacts | E | F |
|--------------------------|------------------|-----------------|-----|-----|
| BM20B(0.6)-10DP-0.4V(51) | CL0684-9300-6-51 | 10 | 3.4 | 1.6 |
| BM20B(0.6)-20DP-0.4V(51) | CL0684-9301-9-51 | 20 | 5.4 | 3.6 |
| BM20B(0.6)-24DP-0.4V(51) | CL0684-9302-1-51 | 24 | 6.2 | 4.4 |
| BM20B(0.6)-30DP-0.4V(51) | Under planning | 30 | 7.4 | 5.6 |
| BM20B(0.6)-34DP-0.4V(51) | Under planning | 34 | 8.2 | 6.4 |
| BM20B(0.6)-40DP-0.4V(51) | CL0684-9305-0-51 | 40 | 9.4 | 7.6 |

| Part No | HRS No. | No. of Contacts | E | F |
|--------------------------|------------------|-----------------|------|-----|
| BM20B(0.8)-10DP-0.4V(51) | CL0684-9001-5-51 | 10 | 3.4 | 1.6 |
| BM20B(0.8)-20DP-0.4V(51) | CL0684-9002-8-51 | 20 | 5.4 | 3.6 |
| BM20B(0.8)-24DP-0.4V(51) | CL0684-9003-0-51 | 24 | 6.2 | 4.4 |
| BM20B(0.8)-30DP-0.4V(51) | CL0684-9004-3-51 | 30 | 7.4 | 5.6 |
| BM20B(0.8)-34DP-0.4V(51) | CL0684-9019-0-51 | 34 | 8.2 | 6.4 |
| BM20B(0.8)-40DP-0.4V(51) | CL0684-9005-6-51 | 40 | 9.4 | 7.6 |
| BM20B(0.8)-44DP-0.4V(51) | Under planning | 44 | 10.2 | 8.4 |
| BM20B(0.8)-50DP-0.4V(51) | Under planning | 50 | 11.4 | 9.6 |

Note 1: This product is sold by full reel quantities of 8,000 pieces per reel. Please place orders in full reel quantities.

Note 2: This connector is NOT polarized.

◆ Operating Precautions

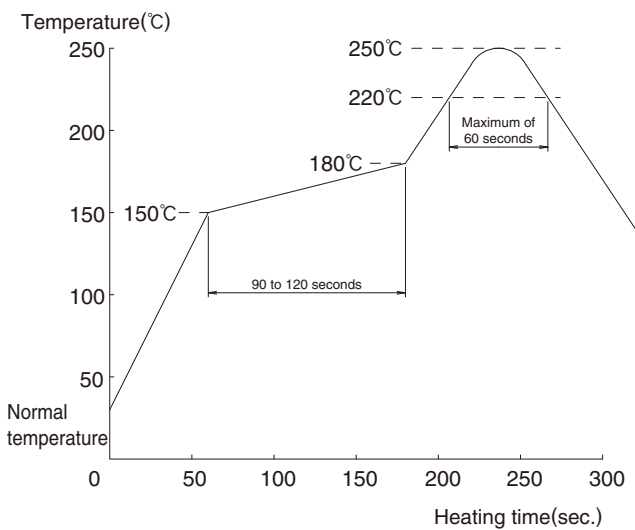
| | |
|--|--|
| <p>1. Recommended Solder Profile</p> |  <p>[Applicable Conditions]</p> <ol style="list-style-type: none"> 1. Peak temperature: 250°C peak 2. Heating parts: 220°C or above, within 60 seconds 3. Preheating parts: 150 to 180°C, 90 to 120 seconds 4. Number of times: Maximum of 2 reflow cycles <p>(Note 1) The temperatures mentioned above refer to the PCB surface temperature near the connector leads.</p> <p>(Note 2) When using nitrogen reflow please implement 1,000 [ppm] or higher oxygen density.</p> <p>Please contact the sales representative of our company in case of less than 1,000 [ppm].</p> |
| <p>2. Recommended hand solder conditions</p> | <p>The temperature of the soldering iron should fall within the range of $340 \pm 10^\circ\text{C}$ and should not make contact for longer than 3 seconds</p> |
| <p>3. Recommended screen thickness: Opening ratio (pattern area ratio)</p> | <p>Thickness: 0.1 mm Opening ratio: DS side 70% DP side 80%(H=0.8mm) DP side 70%(H=0.6mm)</p> |
| <p>4. Leaning of PCB</p> | <p>Maximum of 0.02 mm at the center of connector (using both edges of connector as criteria)</p> |
| <p>5. Washing</p> | <p>Cleaning is not recommended for this connector. Cleaning agents can deteriorate the mechanical operation and the environmental resistance of this connector.</p> |
| <p>6. Precautions</p> | <ul style="list-style-type: none"> ■ Do not mate or unmate these connectors until they are mounted, failure to follow this precaution can lead to deformation or damage to these connectors. ■ Provide another form of support to the PCB, this connector was not designed to be the main form of support. ■ Using excessive force to mate or unmate this connector can damage the contacts. ■ Do not apply excessive amounts of flux as it may cause the solder and flux to wick. ■ There may be a slight variance in the color of the molding between production lots, this variance will not affect the performance of the connector. ■ Refer to the next page for the handling precautions when mating and unmating the connectors. ■ If the connector becomes disconnected due to impact, a fall or a counterforce to the FPC, it may be necessary to hold the connector in place with an addition to the device's case or other cushioning material to hold the connector in place. |

Aug. 1. 2019 Copyright 2019 HIROSE ELECTRIC CO., LTD. All Rights Reserved.

● Handling precautions when mating

| | |
|---|--|
|  <p>BM20*(#)-*DP-0.4V</p> <p>BM20*(#)-*DS-0.4V</p> | |
|  | <p>Prior to mating, locate the guidance ribs and align the header. Do not apply excessive force during the mating process as it may damage the contacts.</p> |
|  | <p>Make sure that the connector is parallel to the other side, then press it down until it is fully mated while maintaining the angle.</p> |

Aug. 1. 2019 Copyright 2019 HIROSE ELECTRIC CO., LTD. All Rights Reserved.

● Handling precautions for unmating

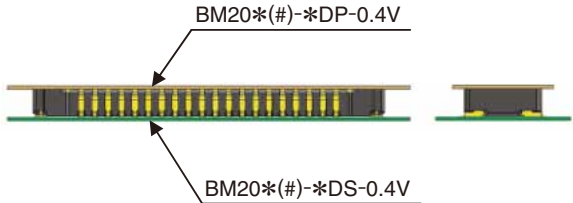
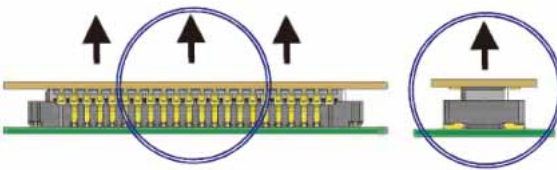
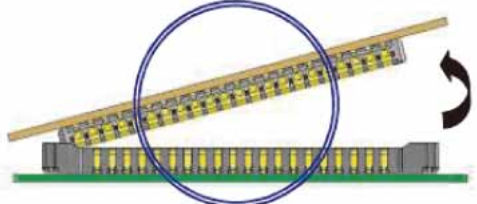
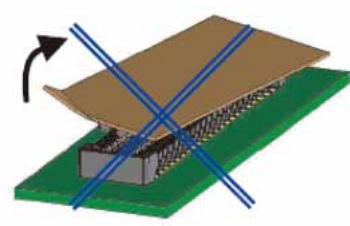
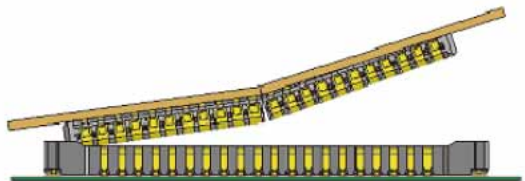
| | |
|---|---|
|  | |
|  | <p>To unmate this connector, lift evenly across the header. Make sure that each side of the connector stays parallel to the other.</p> |
|  <p>Pitch direction</p> | <p>If circumstances prevent the connectors from staying parallel to each other, then one side may be lifted as shown in the diagram. This method is only approved if the connector is mounted onto an extremely rigid circuit board. If the board were to warp during this process it may result in damage to the connector or its solder joints.</p> |
|  <p>Corner direction</p> | <p>Do not try to disconnect these connectors by pulling on one side or a single corner, or to unmate it when it hasn't been securely mounted onto a rigid FPC. These actions may lead to deformities and ultimately a damaged connector. Prior to the mounting of these connectors we recommend that you check the rigidity of your FPC to ensure that it meets the standards needed to support these connectors.</p> |
|  | <p>If the FPC is not strong enough by itself, a stiffening backing may be applied. If the FPC has a low rigidity the connector may break (as shown in the illustration to the left). We recommend a backing of no less than 0.3 mm of glass epoxy and 0.2 mm of stainless material.</p> |

Aug. 1. 2019 Copyright 2019 HIROSE ELECTRIC CO., LTD. All Rights Reserved.

USA:

HIROSE ELECTRIC (U.S.A.), INC. Headquarters
 2688 Westhills Court, Simi Valley, CA 93065-6235
 Phone : +1-805-522-7958
 Fax : +1-805-522-3217
<http://www.hiroseusa.com>

USA:

HIROSE ELECTRIC (U.S.A.), INC. San Jose Office
 3255 Scott Boulevard, Building 7, Suite 101
 Santa Clara, CA 95054
 Phone : +1-408-253-9640
 Fax : +1-408-253-9641
<http://www.hiroseusa.com>

USA:

HIROSE ELECTRIC (U.S.A.), INC. Detroit Office (Automotive)
 37677 Professional Center Drive, Suite #100C
 Livonia, MI 48154
 Phone : +1-734-542-9963
 Fax : +1-734-542-9964
<http://www.hiroseusa.com>

THE NETHERLANDS:

HIROSE ELECTRIC EUROPE B.V.
 Hogehillweg #8 1101 CC Amsterdam Z-O
 Phone : +31-20-6557460
 Fax : +31-20-6557469
<http://www.hiroseeurope.com>

GERMANY:

HIROSE ELECTRIC EUROPE B.V. German Branch
 Herzog-Carl-Strasse 4 D-73760 Ostfildern
 (Scharnhauser Park)
 Phone : +49-711-4560-02-1
 Fax : +49-711-4560-02-299
<http://www.hirose.de>

UNITED KINGDOM:

HIROSE ELECTRIC EUROPE B.V. UK Branch
 22 Vincent Avenue, Crownhill Business
 Centre, Crownhill, Milton Keynes, MK8 0AB
 Phone : +44-1908-305750
 Fax : +44-1908-305768
<http://www.hirose.co.uk>

CHINA:

HIROSE ELECTRIC TRADING (SHANGHAI) CO., LTD.
 1601, Henderson Metropolitan, NO.300, East Nanjing
 Road, Huangpu District, Shanghai, China 200001
 Phone : +86-21-6391-3355
 Fax : +86-21-6391-3335
<http://www.hirose-china.com.cn>

CHINA:

HIROSE ELECTRIC TRADING (SHANGHAI) CO., LTD. Beijing Branch
 A1001, Ocean International Center, Building 56# East 4th
 Ring Middle Road, Chao Yang District, Beijing, 100025
 Phone : +86-10-5165-9332
 Fax : +86-10-5908-1381
<http://www.hirose-china.com.cn>

CHINA:

HIROSE ELECTRIC TECHNOLOGIES (SHENZHEN) CO., LTD.
 Room 09-13, 19/F, Office Tower Shun Hing Square, Di Wang Commercial Centre
 5002, ShenNanDong Road, ShenZhen City, Guangdong Province, 518008
 Phone : +86-755-8207-0851
 Fax : +86-755-8207-0873
<http://www.hirose-china.com.cn>

HONG KONG:

HIROSE ELECTRIC HONGKONG TRADING CO., LTD.
 Room 1001, West Wing, Tsim Sha Tsui Centre, 66
 Mody Road, Tsim Sha Tsui East, Kowloon, Hong Kong
 Phone : +852-2803-5338
 Fax : +852-2591-6560
<http://www.hirose-hongkong.com.hk>

TAIWAN:

HIROSE ELECTRIC TAIWAN CO., LTD.
 103 8F, No.87, Zhengzhou Rd., Taipei
 Phone : +886-2-2555-7377
 Fax : +886-2-2555-7350
<http://www.hirose-taiwan.com.tw>

KOREA:

HIROSE KOREA CO., LTD.
 1261-10, Jeoungwhang-Dong, Shihung-City,
 Kyunggi-Do 429-450
 Phone : +82-31-496-7000, 7124
 Fax : +82-31-496-7100
<http://www.hirose.co.kr>

SINGAPORE:

HIROSE ELECTRIC SINGAPORE PTE. LTD.
 10 Anson Road #26-1 International Plaza
 079903
 Phone : +65-6324-6113
 Fax : +65-6324-6123
<http://www.hirose-singapore.com.sg>

INDIA:

HIROSE ELECTRIC SINGAPORE PTE. LTD. Bangalore Liaison office
 Unit No.03, Ground Floor, Explorer Building International Tech
 Park Whitefield Road, Bangalore 560066 Karnataka, India
 Phone : +65-6324-6113
 Fax : +65-6324-6123
<http://www.hirose-singapore.com.sg>

INDIA:

HIROSE ELECTRIC SINGAPORE PTE. LTD Delhi Liaison Office
 Suite No. 606 5th Floor SB Tower 1A/1 Sector
 16 A Filmcity Noida 201301 Uttar Pradesh-India
 Phone : +91-120-4804917
 Fax : +91-120-4804949
<http://www.hirose.com/sg/>

MALAYSIA:

HIROSE ELECTRIC SINGAPORE PTE. LTD (Representative office)
 1-10-07, Suntech @ Penang Cybercity (1164), Lintang
 Mayang Pasir 3, 11950, Bayan Baru, Penang, Malaysia.
 Phone : +604-619-2564
 Fax : +604-619-2574
<http://www.hirose.com/sg/>



HIROSE ELECTRIC CO.,LTD.

6-3, Nakagawa Chuoh-2-Chome, Tsuzuki-Ku, Yokohama-Shi 224-8540, JAPAN
 TEL: +81-45-620-3526 Fax: +81-45-591-3726
<http://www.hirose.com>
<http://www.hirose-connectors.com>

Looking for pricing, stock, or lifecycle information?

Click below to explore more details on WIN SOURCE:

- [View BM20B\(0.8\)-20DS-0.4V\(53\) on WIN SOURCE](#)
- [Hirose Electric Co Ltd Information](#)

Optimize Your Supply Chain with WIN SOURCE Solutions

- ✓ Global Sourcing Solution
- ✓ Obsolete Management
- ✓ Cost Control Management
- ✓ Shortage Management
- ✓ Alternative Solution
- ✓ Excess Inventory Management