



**THE DATASHEET OF  
CD214B-R2200**





## Features

- RoHS compliant\*
- Glass passivated chip
- Low reverse leakage current
- Low forward voltage drop
- High current capability

## CD214B-R250~R21000 Glass Passivated Rectifiers

### General Information

The markets of portable communications, computing and video equipment are challenging the semiconductor industry to develop increasingly smaller electronic components. Bourns offers Glass Passivated Rectifiers for rectification applications, in compact chip DO-214AA (SMB) size format, which offer PCB real estate savings and are considerably smaller than most competitive parts. The Glass Passivated Rectifier Diodes offer a forward current of 2.0 A with a choice of repetitive peak reverse voltage of 50 V up to 1000 V.

Bourns® Chip Diodes conform to JEDEC standards, are easy to handle on standard pick and place equipment and their flat configuration minimizes roll away.

### Electrical Characteristics (@ T<sub>A</sub> = 25 °C Unless Otherwise Noted)

| Parameter   | Symbol            | CD214B- |       |       |       |       |       |        | Unit |
|---|-------------------|---------|-------|-------|-------|-------|-------|--------|------|
|   |                   | R250    | R2100 | R2200 | R2400 | R2600 | R2800 | R21000 |      |
| Maximum Repetitive Peak Reverse Voltage   | V <sub>RRM</sub>  | 50      | 100   | 200   | 400   | 600   | 800   | 1000   | V    |
| Maximum RMS Voltage   | V <sub>RMS</sub>  | 35      | 70    | 140   | 280   | 420   | 560   | 700    | V    |
| Maximum DC Blocking Voltage   | V <sub>DC</sub>   | 50      | 100   | 200   | 400   | 600   | 800   | 1000   | V    |
| Max. Average Forward Rectified Current <sup>1</sup>   | I <sub>(AV)</sub> | 2.0     |       |       |       |       |       |        | A    |
| DC Reverse Current @ Rated DC Blocking Voltage (@T <sub>J</sub> = 25 °C)                          | I <sub>R</sub>    | 5.0     |       |       |       |       |       |        | μA   |
| DC Reverse Current @ Rated DC Blocking Voltage (@T <sub>J</sub> = 125 °C)                         | I <sub>R</sub>    | 30      |       |       |       |       |       |        | μA   |
| Typical Junction Capacitance <sup>2</sup>   | C <sub>J</sub>    | 25      |       |       |       |       |       |        | pF   |
| Maximum Instantaneous Forward Voltage @ 1 A   | V <sub>F</sub>    | 1.0     |       |       |       |       |       |        | V    |
| Typical Thermal Resistance <sup>3</sup>   | R <sub>θJL</sub>  | 16      |       |       |       |       |       |        | °C/W |
| Peak forward surge current 8.3 ms single half sine-wave superimposed on rated load (JEDEC Method) | I <sub>FSM</sub>  | 65      |       |       |       |       |       |        | A    |

Notes:

1 See Forward Derating Curve.

2 Measured @ 1.0 MHz and applied reverse voltage of 4.0 VDC.

3 Thermal resistance from junction to ambient and from junction to lead P.C.B. mounted on 0.2" x 0.2" (5.0 mm x 5.0 mm) copper pad areas.

### Thermal Characteristics (@ T<sub>A</sub> = 25 °C Unless Otherwise Noted)

| Parameter                   | Symbol           | CD214B-R250~R21000 | Unit |
|-----------------------------|------------------|--------------------|------|
| Operating Temperature Range | T <sub>J</sub>   | -65 to +175        | °C   |
| Storage Temperature Range   | T <sub>STG</sub> | -65 to +170        | °C   |

\*RoHS Directive 2002/95/EC Jan 27, 2003 including Annex.

Specifications are subject to change without notice.

Customers should verify actual device performance in their specific applications.

# CD214B-R250~R21000 Glass Passivated Rectifiers

**BOURNS®**

## Product Dimensions

This is an RoHS compliant product. It is a molded plastic package. A cathode band indicates the polarity. The package weighs approximately 0.064 g. The package and dimensions are shown below.

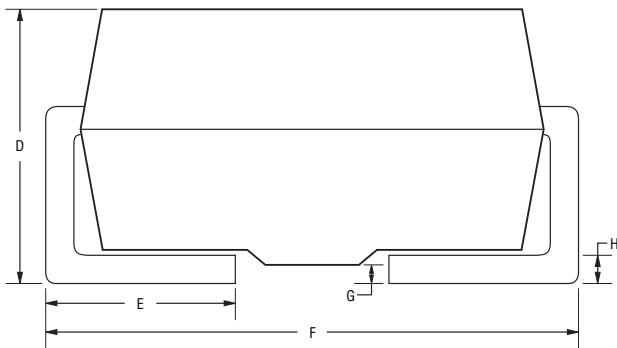
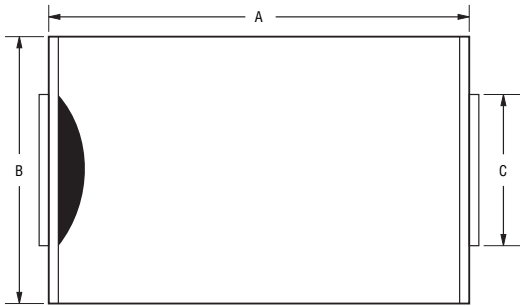

| Dimensions |   |
|------------|---|
| A          | $\frac{4.06 - 4.57}{(0.167 - 0.187)}$     |
| B          | $\frac{3.30 - 3.94}{(0.130 - 0.150)}$     |
| C          | $\frac{1.96 - 2.21}{(0.075 - 0.087)}$     |
| D          | $\frac{2.01 - 2.62}{(0.079 - 0.096)}$     |
| E          | $\frac{0.76 - 1.52}{(0.039 - 0.055)}$     |
| F          | $\frac{5.21 - 5.59}{(0.197 - 0.236)}$     |
| G          | $\frac{0.05 - 0.20}{(0.00196 - 0.00787)}$ |
| H          | $\frac{0.15 - 0.31}{(0.006 - 0.016)}$     |

DIMENSIONS:  $\frac{\text{MM}}{\text{(INCHES)}}$

## Recommended Pad Layout

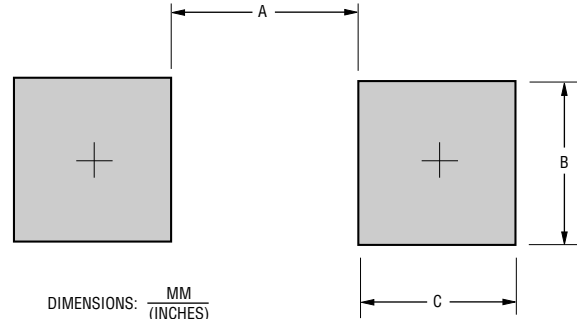

DIMENSIONS:  $\frac{\text{MM}}{\text{(INCHES)}}$

| Dimension | SMB (DO-214AA)         |
|-----------|------------------------|
| A (Max.)  | $\frac{2.69}{(0.106)}$ |
| B (Min.)  | $\frac{2.10}{(0.083)}$ |
| C (Min.)  | $\frac{1.27}{(0.050)}$ |

## How To Order

**CD 214B - R 2 50**

Common Code \_\_\_\_\_  
 Chip Diode \_\_\_\_\_  
 Package \_\_\_\_\_  
 • 214B = SMB/DO-214AA  
 Model \_\_\_\_\_  
 R = Glass Pasivated Rectifiers  
 Forward Current  $I_{AV}$  \_\_\_\_\_  
 2 = 2 A  
 Reverse Voltage \_\_\_\_\_  
 50 = 50 V  
 100 = 100 V  
 200 = 200 V  
 400 = 400 V  
 600 = 600 V  
 800 = 800 V  
 1000 = 1000 V

# CD214B-R250~R21000 Glass Passivated Rectifiers



## Rating and Characteristic Curves

### Forward Current Derating Curve

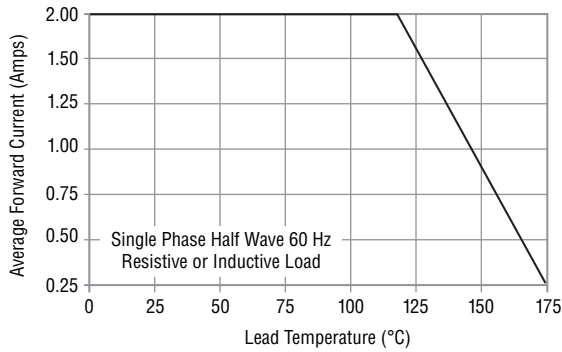

### Non-Repetitive Surge Current

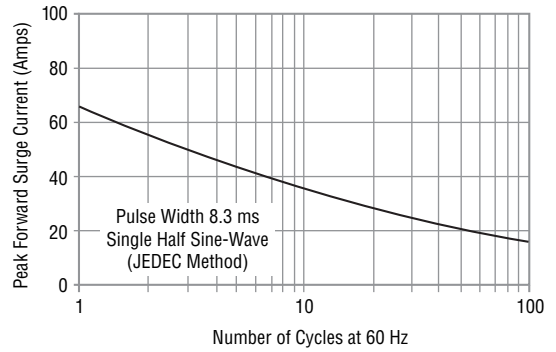

### Forward Characteristics

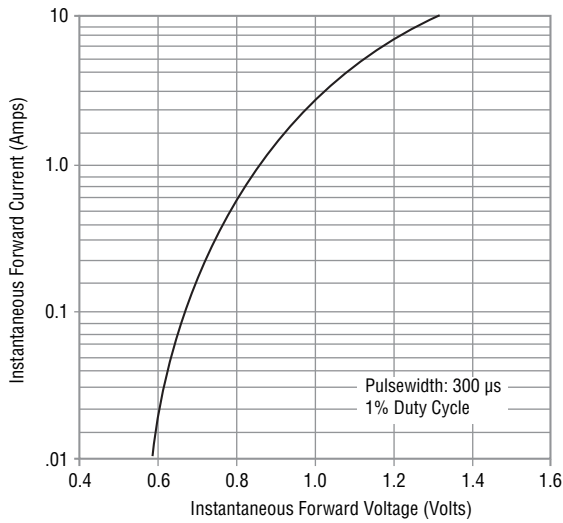

### Reverse Characteristics

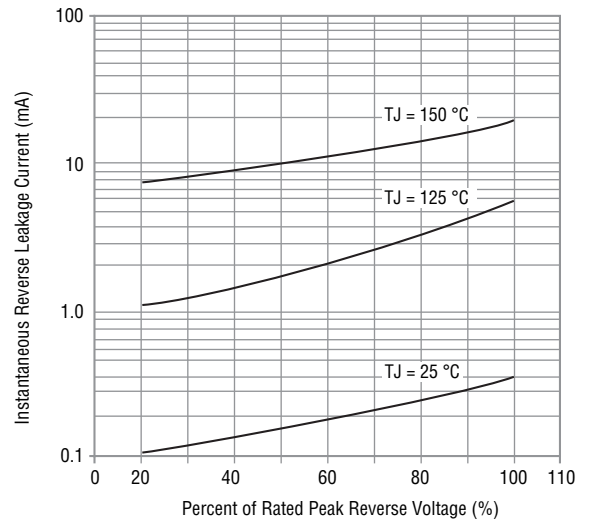

Specifications are subject to change without notice.  
Customers should verify actual device performance in their specific applications.

# CD214B-R250~R21000 Glass Passivated Rectifiers

**BOURNS®**

## Packaging Information

The surface mount product is packaged in an 8 mm x 4 mm tape and reel format per EIA-481 standard.

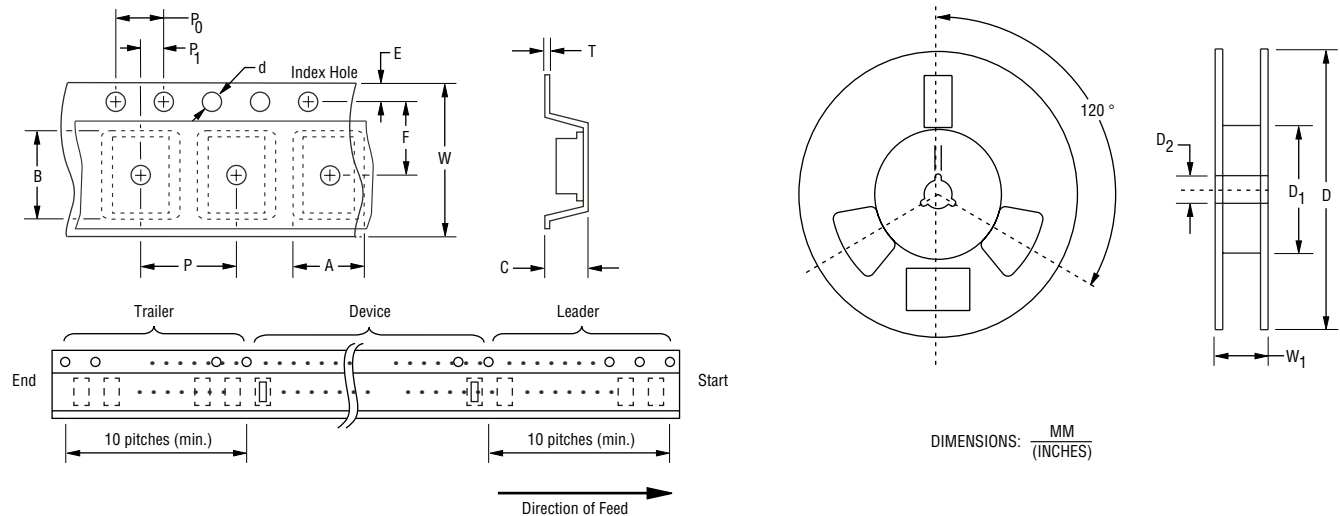

| Item                   | Symbol         | DO-214AA (SMB)                          |
|------------------------|----------------|---|
| Carrier Width          | A              | $\frac{1.90 \pm 0.10}{(0.075 - 0.004)}$ |
| Carrier Length         | B              | $\frac{4.30 \pm 0.10}{(0.169 - 0.004)}$ |
| Carrier Depth          | C              | $\frac{1.80 \pm 0.10}{(0.071 - 0.004)}$ |
| Sprocket Hole          | d              | $\frac{1.55 \pm 0.05}{(0.061 - 0.002)}$ |
| Reel Outside Diameter  | D              | $\frac{178}{(7.008)}$                   |
| Reel Inner Diameter    | D <sub>1</sub> | $\frac{80.0}{(3.150)}$ Min.             |
| Feed Hole Diameter     | D <sub>2</sub> | $\frac{13.0 \pm 0.20}{(0.512 - 0.008)}$ |
| Sprocket Hole Position | E              | $\frac{1.75 \pm 0.10}{(0.069 - 0.004)}$ |
| Punch Hole Position    | F              | $\frac{3.50 \pm 0.05}{(0.138 - 0.002)}$ |
| Punch Hole Pitch       | P              | $\frac{4.00 \pm 0.10}{(0.157 - 0.004)}$ |
| Sprocket Hole Pitch    | P <sub>0</sub> | $\frac{4.00 \pm 0.10}{(0.157 - 0.004)}$ |
| Embossment Center      | P <sub>1</sub> | $\frac{2.00 \pm 0.05}{(0.079 - 0.002)}$ |
| Overall Tape Thickness | T              | $\frac{0.20 \pm 0.10}{(0.008 - 0.004)}$ |
| Tape Width             | W              | $\frac{8.00 \pm 0.20}{(0.315 - 0.008)}$ |
| Reel Width             | W <sub>1</sub> | $\frac{13.5}{(0.531)}$ Max.             |
| Quantity per Reel      | —              | 2,500                                   |

**BOURNS®**

**Asia-Pacific:**  
Tel: +886-2 2562-4117 • Fax: +886-2 2562-4116

**Europe:**  
Tel: +41-41 768 5555 • Fax: +41-41 768 5510

**The Americas:**  
Tel: +1-951 781-5500 • Fax: +1-951 781-5700

[www.bourns.com](http://www.bourns.com)

REV. 06/11

Specifications are subject to change without notice.  
Customers should verify actual device performance in their specific applications.

## Looking for pricing, stock, or lifecycle information?

Click below to explore more details on WIN SOURCE:

 [View CD214B-R2200 on WIN SOURCE](#)

 [Bourns Inc. Information](#)

## Optimize Your Supply Chain with WIN SOURCE Solutions

-  Global Sourcing Solution
-  Obsolete Management
-  Cost Control Management
-  Shortage Management
-  Alternative Solution
-  Excess Inventory Management